









Digitized by the Internet Archive
in 2007 with funding from
Microsoft Corporation





TEXTBOOK
OF
MILITARY AERONAUTICS

NO. 1000
AUGUST 1918



We must build larger air fleets and put the fear of God in the German heart by conducting major aerial operations against the German fleet, U-boat bases, military bases, manufacturing centers, supply depots and railroads. This illustration visualized the destruction of German bases across the Rhine by Allied Air fleets.

TEXTBOOK OF MILITARY AERONAUTICS

BY
HENRY WOODHOUSE

AUTHOR OF "TEXTBOOK OF NAVAL AERONAUTICS"

MEMBER OF THE BOARD OF GOVERNORS OF AERO CLUB OF AMERICA, VICE-PRESIDENT
AERIAL LEAGUE OF AMERICA, MEMBER OF NATIONAL AERIAL COAST PATROL COM-
MISSION, CHAIRMAN OF COMMITTEE OF FLYING EQUIPMENT COOPERATING
WITH COMMANDANT OF THIRD NAVAL DISTRICT IN ORGANIZING NAVAL
RESERVE FORCES, TRUSTEE AND CHAIRMAN OF COMMITTEE ON
AERONAUTICS NATIONAL INSTITUTE OF EFFICIENCY, MEM-
BER OF THE SOCIETY OF AUTOMOTIVE ENGINEERS,
EDUCATIONAL AND INDUSTRIAL DELEGATE,
PAN-AMERICAN FEDERATION, ETC., ETC.



UNIV. OF
CALIFORNIA

NEW YORK
THE CENTURY CO.

1918

U.G. 630
W6

Copyright, 1918, by
THE CENTURY Co.

Published, May, 1918

TO VIAL
ABRORLIAO

PREFACE

One of the purposes of this book is to make available to our prospective American aviators the educational information regarding the manner in which aviators fight the enemy—information which the enemy gets whenever Allied aviators are brought down and printed instructions are found on them, and by daily observations of what the Allied aviators do.

The author has found by talking to Allied officers and from the score or so of periodicals of the European countries engaged in this war that all information about *modus operandi* and aeroplanes and devices becomes known to the enemy almost immediately, through the capture of aeroplanes and aviators and through observation of repetition of actions.

Another purpose of this book is to supply to military authorities an illustrated pen picture of the history of the evolution of military aeronautics, its present status, and the direction of its development.

The hundreds of letters received from naval officers regarding the value to them of the "Textbook of Naval Aeronautics" convinced the author of the need for a similar book about military aeronautics rather than for a book dealing with the mechanics of military aircraft and their equipment, an extensive subject that would fill a book as large as this volume.

The following excerpts of letters from the commanding officers of war-ships give the general sentiment expressed in the letters received about the "Textbook of Naval Aeronautics," which are close to one thousand in number.

Acknowledging the receipt of two copies of the text-book, one for himself and one for the ship's library, for the use of the crew, the commanding officer of a United States war-ship writes:

I know they will be of incalculable value. I have already spent some pleasant and instructive hours in reading a copy and must admit I knew little of the state of the art as applied to naval aeronautics until

this time, and I am sure officers and men will be astonished to know how far this science has progressed in our service, and I am further satisfied it will awaken keener interest in this branch of naval activity and produce recruits for this service among our skilled mechanics and those daring souls to whom the routine life aboard battle-ships may become irksome.

There is as much difference between aerial warfare in connection with army operations and aerial warfare in connection with naval operations as there is between the operations of the army and navy proper. The naval aviator who has to hunt submarines, convoy troop-ships, locate submarine mines, patrol the sea-lanes, and manœuvre his aircraft over the sea in scouting or bomb-dropping expeditions must have a training which is entirely different from that of the military aviator, who locates and watches the movements of the enemy's artillery and infantry, photographs the enemy's positions, and coöperates in attacking soldiers in the trenches or on the march, etc.

Hence the necessity of the two books.

Supremacy in the air is the key to victory.

"Had the Allies one thousand more aeroplanes, we could have easily defeated the Germans."

This is the general expression that one hears as the German offensive is raging. It is an official as well as a public expression, and everybody scans the reports to find out what the aeroplanes are doing and whether the Allies have sufficient aeroplanes to maintain that supremacy in the air which is necessary to decide the war in favor of the Allies.

With one thousand additional warplanes, the Allies would have been able to prevent German aviators from mapping the Allied positions; and could have destroyed the military bases, munition-dumps, gun emplacements, the railroads upon which the troops, munitions, and supplies were transported. In short, they could have prevented the massing of such a huge body of

PREFACE

troops as the Germans massed for this drive.

Aeroplanes are the only things that can pass the German lines. They can fly over the German lines and they can do so at night, when neither the anti-aircraft batteries nor the German aeroplanes can see them.

Unfortunately, the Allies did not have this additional aerial force. To keep one thousand well-trained aviators on the fighting fronts, employing them daily, involves about forty per cent. replacements in aviators, and from one hundred to two hundred per cent. replacements in machines per month. In other words, it takes six hundred aviators per month to keep one thousand fighting continuously, operating day and night. Not all of these aviators are killed or hurt. A large number just "wear out" after a few weeks or months of intensive service, and cannot continue. They must be sent back to rest or to be employed in other work.

As for machines, they are used fast and in large numbers. The anti-craft guns are quite accurate at heights of fifteen thousand feet; and speeds up to one hundred and forty miles an hour are necessary to maintain supremacy in the air. Landing such fast machines in small fields leads to damaging a great many.

However, when we consider the tremendous value of each aviator, we find that the air service is the most important and economic branch of the fighting forces.

The accounts show that in 1918 night operations by aeroplanes are used more extensively.

One of the despatches summarizes some of the activities of the aviators as follows:

In moonlight of sufficient brilliance to permit the reading of a newspaper, bombing planes and warplanes swarm out, carrying high explosives, far behind the battle zone. They broaden the area of death scores of miles, few villages escaping.

When the sun rises, the bombers, like prowling night birds, return to their roost; ground fighting speeds up, and scout fleets, succeeding the bombers, fly low over the clashing infantry, harassing enemy columns and observing for the artillery.

One of the reports of the daytime aerial operations reads as follows:

The enemy's low-flying aeroplanes were most persistent in their attack on our infantry in the forward areas. Many of these machines were attacked and brought down by our pilots. A total of twenty-nine hostile machines were brought down and twenty-five others were driven down out of control. Two enemy balloons were also destroyed. Nine of our machines are missing.

Our machines on Saturday carried out another successful raid on factories in Mannheim. Nearly one and a half tons of bombs were dropped, and bursts were seen on a soda factory, the railway, and docks.

Several fires were started, one of which was of great size, with flames reaching to a height of 200 feet and smoke to 5000 feet. The conflagration was visible for a distance of thirty-five miles.

The weather Saturday again favored operations, and our aeroplanes were constantly employed in reconnoitering positions of troops, in photography and bombing, and in reporting suitable targets for our artillery. Many thousands of rounds were fired by our pilots from low altitudes on hostile troops massed in villages and in the open continuously throughout the day.

More than fourteen tons of bombs were dropped on enemy billets, on his high-velocity guns, and on railroad stations in the battle area.

Our bombing-aeroplanes were attacked by thirty-two hostile machines, and a fierce fight ensued. One of the enemy's aeroplanes was brought down in flames, and another was downed, and fell in the center of Mannheim. Five others were driven down out of control.

Despite this severe combat and the enemy's heavy anti-aircraft gunfire, all our machines returned except two. During the night ten heavy bombs were dropped on an important railway's bridge and works at Konz, just south of Treves, in Germany. Eight of these bombs were clearly seen to be bursting among the railway's works.

It is stated officially that this is only the beginning of the intensive warfare that is to follow, one of the great drives that are to follow each other in quick succession hereafter. We must, therefore, concentrate efforts on our aircraft program and put all the manufacturing facilities now standing virtually idle in the United States to turn out aircraft and parts.

No time should be lost in adopting the plan which is to give the Allies the supremacy in the air that is so vital, as it will decide the war in favor of the Allies.

HENRY WOODHOUSE.

INTRODUCTION

As President Wilson has repeatedly pointed out, it is most important that the country be educated to its task.

The workers for aerial preparedness have found in the past that the principal work was to teach the public the importance of aerial preparedness, the tremendous possibilities for the employment of aircraft in connection with every branch of the army and navy,* and independently. To teach the busy military man, so that he would recommend the expansion of the air service to the legislator, so the legislator would support the military man's recommendations; to teach the engineer, so that he would develop better aircraft especially suited for military purposes; and the general public, in order to inspire young men to volunteer their services and men and women to work for the development of our air forces.

Now that the world's strategists agree that the present war is to be decided in the air, and this country has been asked and has undertaken to supply the thousands of aviators and tens of thousands of machines needed to maintain aerial supremacy on the side of the Allies, the great demand is for reliable information regarding the use of aircraft for military purposes.

Executive military officers who want to know the exact status of military aeronautics and the principles of aerial strategy; students learning military aviation who want to know in detail the various phases of aerial warfare; aeronautic engineers and manufacturers who want to know the duties of aircraft, in order to design and make more efficient machines; and the average

patriot who wants to learn about aeronautics in the hope of finding an opening to employ his or her efforts to help the Government in carrying the war to a successful conclusion, will find in this book the publication they have been looking for.

Another commendable point—it has many—is the strong message which the book carries to the American authorities and public. The author brings out once more the importance of air power and urges full-size measures. In this again every one will agree. It is time that we shun half-measures. The greatest of our national sins in aeronautic matters has been over-reliance on minimums—minimum plans, based on minimum understanding of the military and aeronautic situation, further weakened by minimum appropriations. We have also had some minimum men, having minimum knowledge and experience, who did not realize, as one must do in war-times, the possible necessity of quick expansion, the possibility of delays, due to transportation of materials, labor conditions, mistakes, etc.,

The one national resolution that we ought to make in dealing with aeronautics should be to eliminate minimums of all kinds and adopt maximums in programs, men, appropriations, manufacturing facilities, etc. Having adopted maximums, let us add to each, so as to have a substantial margin of safety to insure success under any circumstances.

ALAN R. HAWLEY,
President Aero Club of America.

CONTENTS

	PAGE		PAGE
CHAPTER I THE WAR TO BE DECIDED IN THE AIR	3	CHAPTER V THE FUNDAMENTAL PRINCIPLES OF AERIAL COMBAT	63
Aerial Supremacy Must be Maintained Day and Night—Air Service the First Line of Offence and Defence—The Use of Aircraft in Connection with Military Operations—Aerial Operations Independent of Land Forces—Coöperation Between the Army and the Navy in Conducting Major Operations		CHAPTER VI DIRECTING ARTILLERY FIRE BY NIGHT AND DAY SIGNALING TO AND FROM AIRCRAFT	71
CHAPTER II THE WARPLANE FOR BOMBING AND TORPEDO ATTACKS	9	Methods and Codes Used for Communicating From and to Aircraft—The Observer's Special Map—Signaling With Very's Lights—Kite Balloons for Spotting Artillery Fire—The Dubilier-Goll Semi-Radio Telephone System for Captive Balloons—Signaling Between Aircraft—Coöperation Between Balloons and Artillery	
The New Revolutionary Weapon Which Combines Power, Mobility, and Control, and Permits Major Aerial Operations Against German Military Centers and Naval Bases—Night Raids Can be Conducted Without Difficulty—Allies Have Never Had Enough Large Aeroplanes With Which to Conduct Major Aerial Operations—Huge Warplanes to do at Long Range What Huge Guns Can Only do at Short Range—Proportion of Bombing Planes to be Increased—Huge Warplanes and Torpedoplanes Capable of Carrying Tons of Explosives—The Marvelous Giant Caproni Warplane—French and British Bomb-dropping Machines—The Huge Curtiss Triplane—Long-distance Bombing Raids not New—Long-distance Allied Raids Into Enemy Country in the Western Theatre of War—Extensive Damage Can be Done by Bombs—Night Facilitates Bombing at Close Range—Need of Silencers to Eliminate Noise of Approach—Bombs and Bomb-dropping Mechanism—Bomb Sights—The Scientific Side of Bomb Dropping—Night Bombing Requires Knowledge of Aerial Navigation by Instruments—Night Landing Lights—Navigation Lights—The Sperry Automatic Pilot—Turn Into the Wind to Avoid Drift—Formation for Bombing Raids—Rules for Formation Flying—How 1,000 Warplanes Could Raid Kiel		CHAPTER VII KITE BALLOONS THE EYES OF THE ARTILLERY	81
CHAPTER III DROPPING BOMBS FROM AEROPLANES	31	Maneuvering—Camp Equipment of a Kite Balloon Unit—An Artillery Captain's Experience—Personnel of Kite Balloon Company—Preparations for Ascesion—What You Can See from a Kite Balloon—Aeroplane vs. Captive Balloon—A Leap Into Space from a Kite Balloon—A Curious Maneuver—A Drama at the End of a Cable	
CHAPTER IV BATTLEPLANES AND AIRCRAFT GUNS—THE DOMINANT FACTORS IN MAINTAINING THE SUPREMACY OF THE AIR	39	CHAPTER VIII AERO PHOTOGRAPHY	91
Proportions of Different Types of Armed Aeroplanes in the Air Service—The Five Fundamental Factors in Maintaining Supremacy in the Air—Types of Aeroplanes and Their Armament—Avions de Chasse or Combat Machines—Avions Types "Corps d'arme"—Used for Spotting Artillery Fire, Aerial Photograph, etc.—Pursuit, or Combat Machines—The Triplane—A Scientific Solution of the Problem of Getting Speed and High Factor of Safety—Triplane Safe, Even if Wing is Shot Away—Battleplanes That Collapsed in the Air—Loss of Factor Safety Not Compensated—Large Aerial Destroyers—Aeroplane Guns and Cannon—Large Aeroplane Guns—Problems of Armoring—Vulnerable Parts of the Aeroplane—Bullets vs. High Explosive Shells—Fast vs. Slow Muzzle Velocity—Recoil; a Solved Problem—Tactics in Air Duels—(1) Air Duels in Which Participants are Both Air Fighters Whose Only Function is to Keep the Sky Clear of Enemy Machines—(2) Air Duels Between Combat Machines and Armed Photographing, Spotting, or Bombing Machines—(3) Air Duels Between Large Armed Aeroplanes—Formation in Air Fighting—Lamp Signals for Use of Leaders of Formations—Offensive Fighting Tactics—Thorough Knowledge of Weapons is Required		Thousands of Miles of Photographic Maps—Twenty Per Cent of Aeroplanes at the Front Used for Aerial Photography—The Aerophotographic Organization of an Army—Seven Aeroplane Bombs Photographed Soon After Release by the French Aviator That Released Them on a German Plant—Aeroplane Photography That Shows Minutest Details of a Factory Chimney Being Repaired—A Photographic Officer Should be Familiar With the Following Technical Subjects—Cameras and Fittings—Loading of Plates—Negative Developing—Finish of Work—A Squadron Photographic Non-commissioned Officer With His Three Men Should be Familiar With the Following—Science of Aerophotography Still Young—Essentials in Aerophotographs—Relative Elevations Hard to Show—Interpreting Photographs Requires Skill—Problems of Aerophotography—Different Types of Cameras—Possible Troubles in Taking Aero Photographs and Their Remedy	
		CHAPTER IX RECONNAISSANCE AND CONTACT PATROL WORK BY AEROPLANE	111
		Five Types of Reconnaissance—Procedure in Issuing Orders for Reconnaissance—How Reconnaissance Aeroplanes are Guarded and Protected—Protecting Reconnaissance Machines—Navigation Rules for Reconnaissance—Pilots and Observers—Aircraft Report Diary Contact Patrol (Aeroplanes De Liason)	
		CHAPTER X NIGHT FLYING	125
		Zeppelin Raids Forced Aeroplane Night Flying—Long-distance Bombing Night Raids—Aeroplanes Cannot be Seen One Hundred Feet Away—The Operation of Aeroplanes by Night—Lighting the Aerodromes—The "Honig Circles" Signals for Night Flyers—Lights for Night Landing Grounds—Returning from Night Flights—The Signals—Lighting Equipment of Aeroplanes—Instruments Painted with Luminous Compounds—Adventures in Night Flying	
		CHAPTER XI RADIO FOR AEROPLANES	139

CONTENTS

	PAGE		PAGE
CHAPTER XII MILITARY AEROSTATICS	157		
Dirigible Balloons—Rigid, Semi-Rigid, and Non-Rigid Dirigibles—Military Observation Balloons—Employed at Night as Well as in the Daytime—For Directing Artillery Fire—Hydrogen Supply and the "Nurse"— The Windlass—Free Balloon Training Necessary—The Free Balloons—Synopsis of the Course of Training at United States Army Balloon School			
CHAPTER XIII HYDROGEN FOR MILITARY PUR- POSES	167		
Properties of Hydrogen—Vitriol Process—Electrolytic Method—Silicol Process—Iron Contact Process—Alu- minum Caustic Soda Process—Hydrolithe—Hydroge- nite—Hydrogen from Water—Gas—Aluminum Potas- sium Cyanide Process—Acetylene Process—Iron and Water Process—Silico-Acetylene Process—Decarbura- tion of Oils			
CHAPTER XIV TRAINING AVIATORS FOR THE UNITED STATES ARMY; HOME AND FOR- EIGN SERVICE	179		
Schools of Military Aeronautics (Ground Schools)— Instruction in the Junior Wing—Instruction in the Senior Wing—Training at Army Aviation Schools— Tests for an Aviator's Certificate—Spherical Balloon Pilot's Certificate—Dirigible Balloon Pilot's Certifi- cate—Aviator's Certificate—Hydroaeroplane Pilot's Certificate—United States Army Preliminary Flying Test—United States Army Reserve Military Aviator Test			
CHAPTER XV REGULATIONS FOR UNIFORMS OF U. S. AERONAUTIC PERSONNEL	190		
Uniform Specifications—Coats, Aviator, Anti-sinking— Face Mask, Aviators—Flying Suit—Gloves, Aviator, Winter—Gloves, Aviator, Summer—Goggles—Helmet, Aviators, Summer—Helmet, Aviators, Winter—Avia- tion Service—Mufflers—Shoes, Aviator, Winter—Boots, Rubber, Wading (Wading Pants)—Breeches, Winter, Motoreycles—Insignia, Sleeve—Changes in Regulations for the Uniforms of the United States Army, 1914, to Cover Aviation—Uniforms of the United States Army—Officers—Enlisted Men			
CHAPTER XVI AERONAUTIC MAPS	197		
Five Types of Aeronautic Maps—The Map With Pho- tographic Reproduction of Route and Information Re- garding Prevailing Winds—The War Prevented an International Convention on Aeronautic Cartography —Existing Aeronautic Maps are the Result of Work by Aero Clubs			
CHAPTER XVII HISTORY OF UNITED STATES ARMY AERONAUTICS	204		
Aeroplanes of All Types Purchased by the Signal Corps —The Mexican Campaign Found the United States			
		Army Unprepared Aeronautically—Aircraft Board Created—The \$1,032,294,260 Army Air Program—Long Delay in Extending Plans and Getting Appropria- tions Causes Trouble	
		CHAPTER XVIII THE EVOLUTION OF MILI- TARY AVIATION	222
Signal Corps Specification, No. 486—General Condi- tions of French Military Competition of 1910-1911— The Kaiser's Prize for a Motor Competition—Aero- planes First Used for Military Purposes in the Italian- Turkish War—French Aviation Developed by Public Interest—Firing Guns, Dropping Large Bombs, and Two-engined Aeroplanes Once Considered Impossibil- ities—British Army Tests for Aeroplanes in 1914— Aeronautics at the Outbreak of the War—Advent of Large Warplanes in 1917 Permitted Conducting Major Aerial Operations—The United States Lagged Behind for Seven Years—Aero Club of America's Monumental Work in Developing Our Aerial Forces—America's En- try Into the War Brings Decision to Concentrate Ef- forts to Strike Germany Through the Air—The Prob- lem of Delivering Aeroplanes to Europe—British Air Ministry Created			
		CHAPTER XIX SOME PROBLEMS IN AERO- PLANE CONSTRUCTION	245
Military Functions of Aeroplanes—Some Problems in Construction—Propeller Stresses—Suggestions for Im- provements in Design			
		CHAPTER XX METHODS OF MEASURING AIR- CRAFT PERFORMANCES	259
Aeroplane Testing—Speeds			
		CHAPTER XXI THE SPERRY AUTOMATIC PILOT	269
Incorporating a Gyroscopic Reference Plane and Clin- ometer for Aeroplanes—Its Application for Military Purposes			
		CHAPTER XXII THE CASE FOR THE LARGE AEROPLANE	274
Aerodynamical Bases of Comparison—The Effect of an Increase in Size on the Structural Weight of Aero- planes—The Effect of an Increase in Size Upon an Aeroplane's Performance—The Large Machine from the Pilot's Standpoint			
		CHAPTER XXIII EVERY MILITARY AVIATOR OUGHT TO KNOW WHAT HIS OWN AND THE ENEMY'S MACHINE CAN DO AND HOW THEY LOOK	282
		INDEX	293

**TEXTBOOK
OF
MILITARY AERONAUTICS**

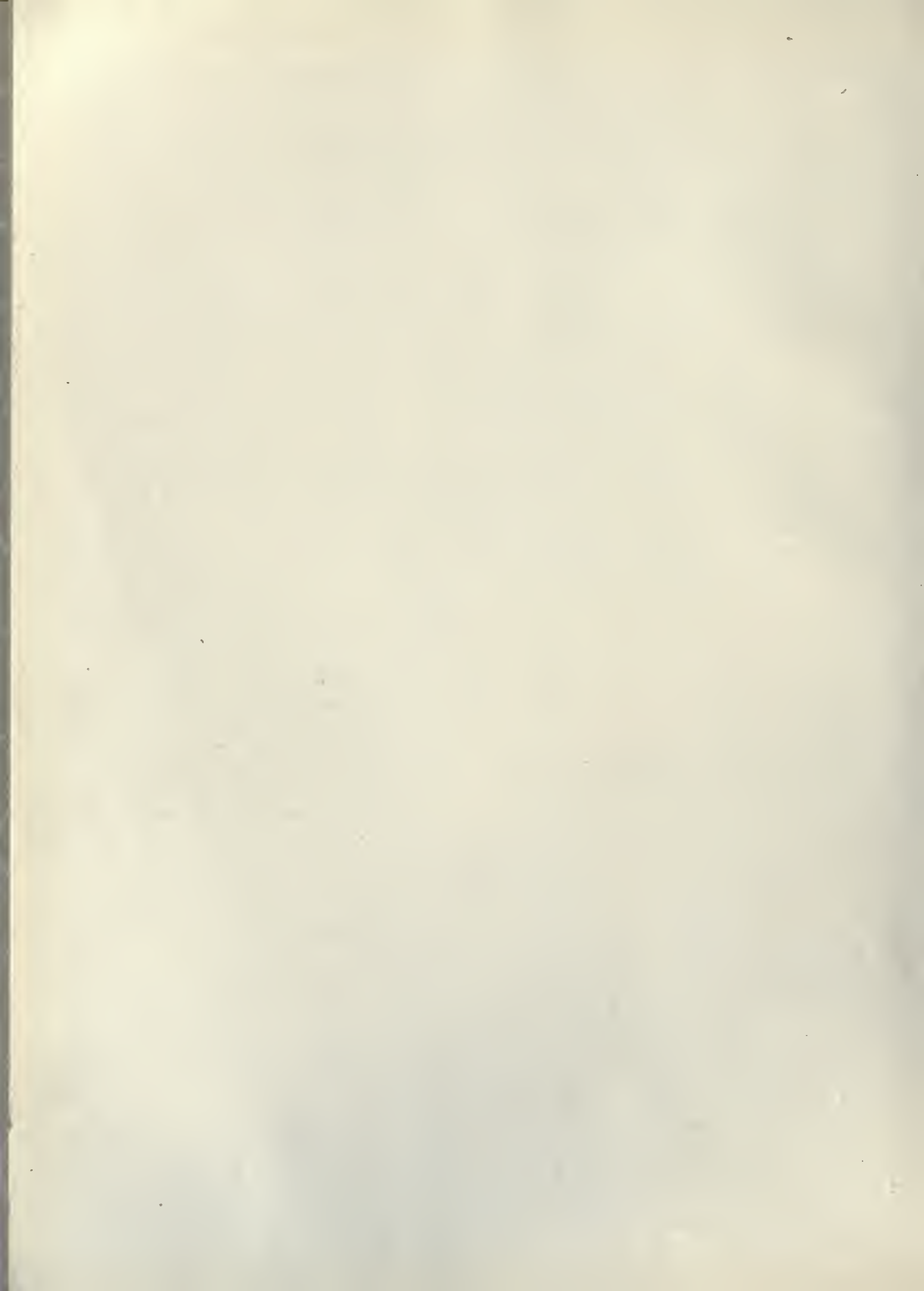

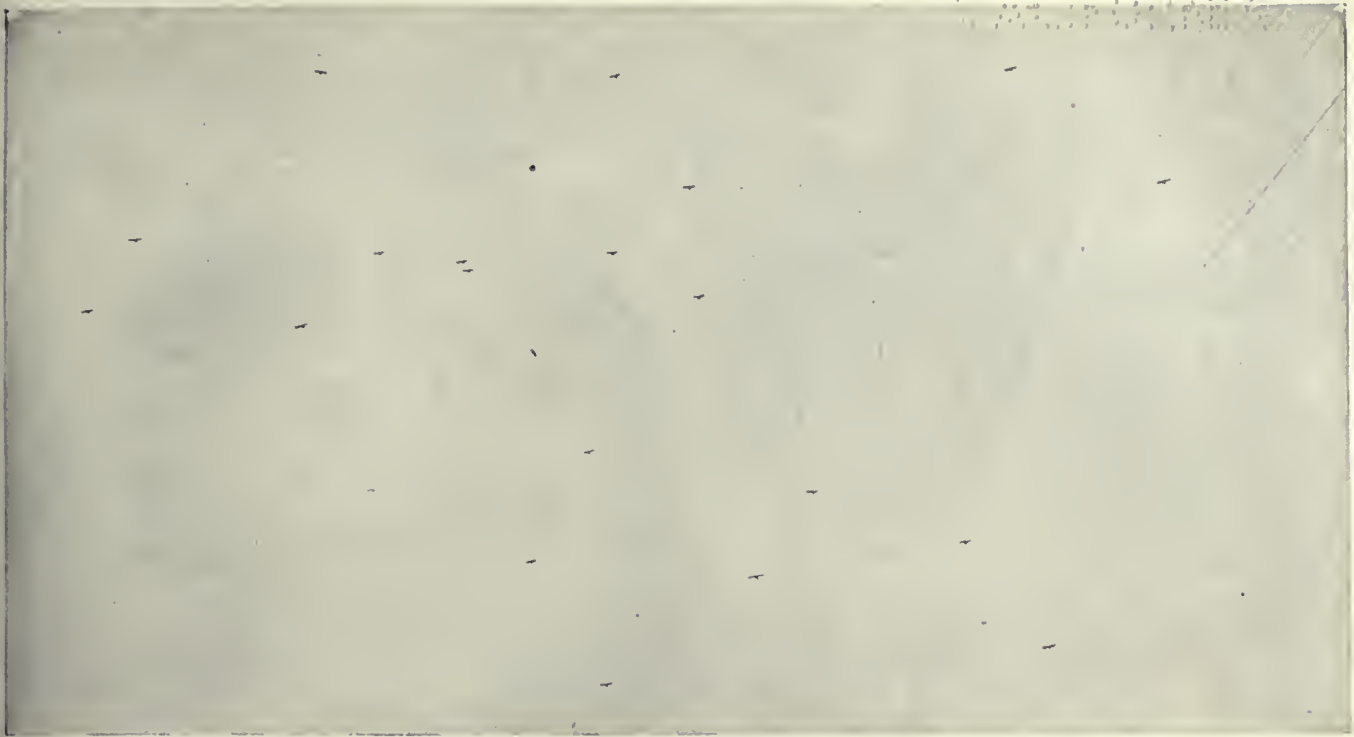

A squadron of Gotha biplanes which raided London in full daylight on July 7th, 1917. They were equipped with two 260 horsepower Mercedes engines and carried 800 pounds of explosives. Forty people were killed and 194 injured.

CHAPTER I

THE WAR TO BE DECIDED IN THE AIR

This war is to be decided in favor of the side which maintains its supremacy in the air through having the largest number of efficient aircraft and airmen.

The world's strategists agree on this point, and the struggle for command of the air is raging.

The air service is the balance of power, a most marvelous power combined with unlimited mobility and control to such a tremendous extent that it makes of the aircraft a new arm of revolutionary potentiality.

Aerial Supremacy Must Be Maintained Day and Night

Command of the air means maintaining supremacy in the air by day and by night.

Holding supremacy of the air during the daytime avails little if the enemy has supremacy of the air at night, and vice versa.

Aerial supremacy at night can be maintained by conducting extensive night-bombing

operations against German military centers, military supply bases, and railroads, and by substantial naval aerial operations, also at night, against the German fleet and U-boat bases, striking the ships of the German fleet with torpedoes launched from torpedoplanes, and the U-boats and their bases with bombs dropped from the air.

Aerial supremacy during the daytime means guarding the different fronts with an overwhelming number of aeroplanes of the fighting type, as well as with the types used for regulating artillery fire, for aerial photography, for scouting, and in connection with infantry and cavalry operations; and by short, daylight, bombing expeditions.

Major aerial operations, supported by energetic military operations on land and naval operations at sea, could, as Admiral Fiske has pointed out repeatedly, in a comparatively brief period of time destroy Germany's strength as nothing else can. They could do more than the addition of a million men on land and five



Caproni warplane—one of the largest warplanes in the world.

naval squadrons at sea could accomplish; because, as is generally admitted, additional men would avail little against the entrenched German lines. Capturing lines at present involves going through many lines of trenches; and that involves lengthy preparatory activities.

The same thing is true at sea; ships and men can do little against the protected German fleet, because of the miles of mines and other defenses which guard it.

As Admiral Fiske has pointed out in the "Textbook of Naval Aeronautics," the large warplane combines power, mobility, and control as no other weapon does, and permits the quick concentration on any given point of large masses of explosives.

Aircraft can fly over all obstructions, both at sea and on the land, as though they did not exist. True, during daylight squadrons of German battleplanes and hundreds of German anti-aircraft guns would attempt to prevent the progress of the Allies' raiding forces, which would involve casualties, although only a fraction of the casualties that result every day in the least important land operations.

Air Service the First Line of Offense and Defense

The air service has become the first line of offense and defense. Every military operation is preceded by aerial operations which include:

(1) Bombing the enemy's bases, destroying railroads, trains, and enemy material.

This is done with bombing aeroplanes, self-sufficient, or protected by fighting machines. (See chapters on "Battleplanes and Aircraft Guns" and "Warplanes for Bombing and Torpedo Attacks.")

(2) Fighting hostile aeroplanes, preventing them from making aerial reconnaissance or taking photographs of one's positions, thus directing the fire of their artillery, etc. Small, fighting aeroplanes are used for this purpose. (See chapter on "Battleplanes and Aircraft Guns.")

(3) Reconnoitering. Determining the strength of the enemy, its composition, dispositions, and probable intentions. Aeroplanes of different types are used for this purpose.

(4) Photographing the enemy positions. These photographs, by giving accurate details of the enemy's position, permit conducting operations based on exact information, and therefore afford the greatest chance for success. Aeroplanes and kite-balloons are used for this purpose.

(5) Directing artillery fire. This is done with both aeroplanes and kite-balloons, and has become an exact science.

(6) Contact patrol. Coördinating the activities of the different arms during attacks. In this rôle the aviator becomes the master-mind that watches over every movement of the enemy,

as well as of his own forces, and transmits to his own forces information regarding the advance, retreat, and other movements of the enemy, directing the sending of reinforcements to the weak or threatened points, and controlling the fire of the machine-gun batteries as well as of the artillery. Aeroplanes of different types are used for this purpose.

(7) Coöperating with the infantry and other arms in taking trenches, by flying low over the trenches and attacking the enemy with machine-guns. Different types of one- or two-passenger aeroplanes are used.

(8) Coöperating with the artillery and other arms by attacking the crews of hostile batteries with machine-guns. Different types of one- or two-passenger aeroplanes are used for this purpose.

(9) Making attacks with bombs or guns against land forces, to engage the enemy and distract his attention from operations which are about to be conducted; in other words, perform-

ing the functions of cavalry, which has been used but little along the western front.

(10) Conducting aerial attacks from the rear with bombs and machine-guns against enemy land-forces, to relieve the pressure being brought by the enemy's forces against any one point, or to wear down the strength of the enemy's land-forces. Different types of battleplanes are used for this purpose.

(11) Preventing reinforcements from reaching the enemy, by flying far into the enemy lines, watching for trains and attacking them with bombs and machine-guns. Different types of battleplanes are used for this purpose.

The Use of Aircraft in Connection with Military Operations

The use of aircraft in connection with military operations has become so extensive that it may be said that the air service, coöperating with the land-forces, is, in itself, an aerial army,

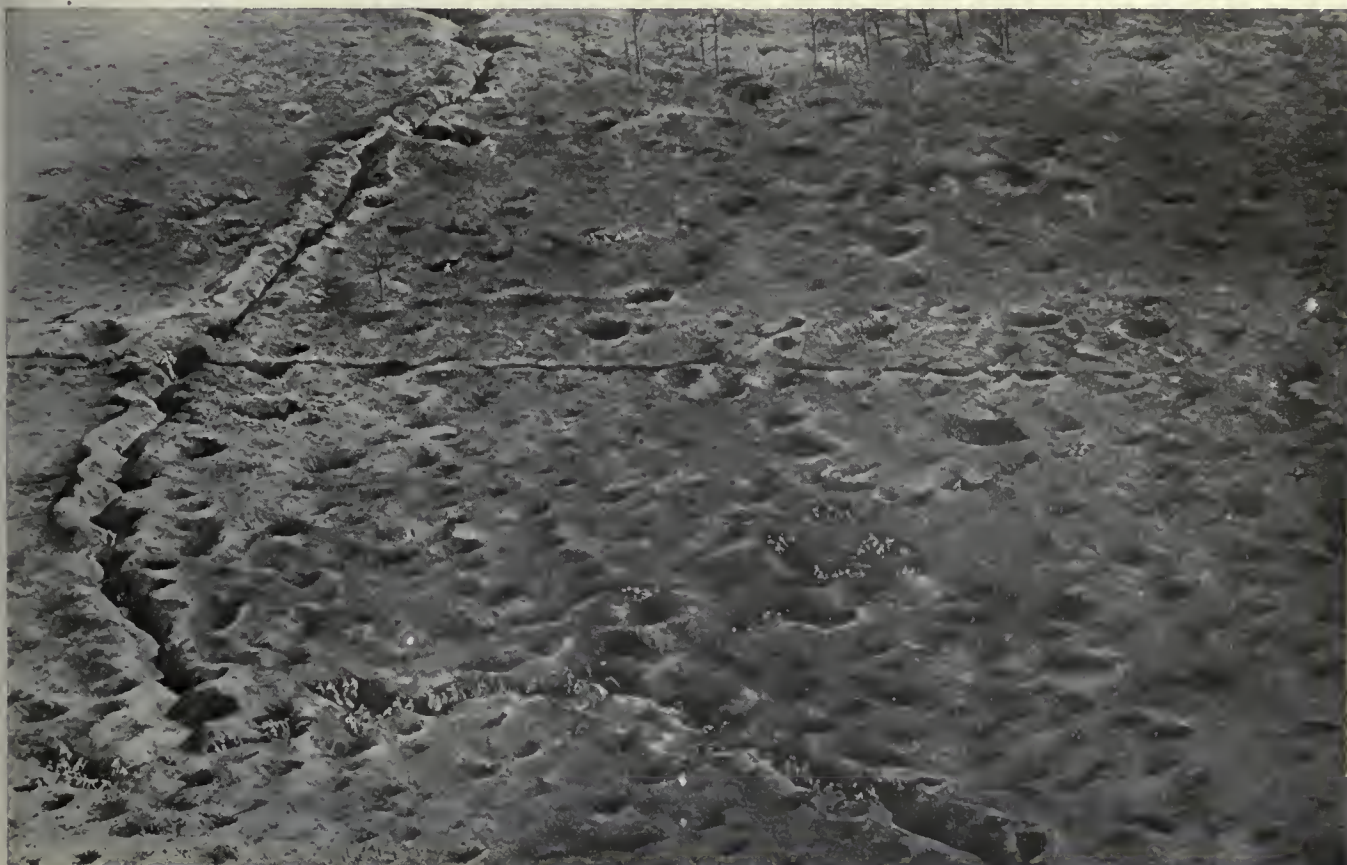

A remarkable photograph of the capture of German trenches by the French infantry on the Somme. This photograph was taken by a French aviator at a height of only 500 feet. The trench in the left foreground, named the Guillaume Trench, had formed the German front line. Slanting up to it from the right-hand corner is a communication-trench, by which French reinforcements are seen arriving. Shell craters are seen everywhere.



Air craft can go over all obstructions which stop the progress of ships and armies. How complete is its supremacy may be seen from the above photograph, taken from an Italian military aeroplane (part of which is shown in the photograph) while crossing the Alps. Italian aviators connected with the Trentin Army flew daily under such conditions.

the aeroplanes performing the function of cavalry, artillery, and infantry.

General Haig, commander-in-chief of the British forces in France, in his official reports has stated repeatedly that the employment of aeroplanes in connection with military operations is practically unlimited.

In one of his latest reports he speaks of the work of the Royal Flying Corps as follows:

"In this combination between infantry and artillery the Royal Flying Corps played a highly important part. The admirable work of this Corps has been a very satisfactory feature of the battle. Under the conditions of modern war the duties of the Air Service are many and varied. They include the regulation and control of artillery fire by indicating targets and observing and reporting the results of rounds; the taking of photographs of enemy trenches, strong points, battery positions, and the effect of bombardments; and the observation of the movements of the enemy behind his lines.

"The greatest skill and daring has been shown in the performance of all these duties, as

well as in bombing expeditions. Our Air Service has also coöperated with our infantry in their assaults, signaling the position of our attacking troops and turning machine-guns on the enemy infantry and even on his batteries in action.

"Not only has the work of the Royal Flying Corps to be carried out in all weathers and under constant fire from the ground, but fighting in the air has now become a normal procedure, in order to maintain the mastery over the enemy's Air Service. In these flights the greatest skill and determination have been shown, and great success has attended the efforts of the Royal Flying Corps. I desire to point out, however, that the maintenance of mastery in the air, which is essential, entails a constant and liberal supply of the most up-to-date machines, without which even the most skilful pilots cannot succeed.

"The style of warfare in which we have been engaged offered no scope for cavalry action, with the exception of the one instance already mentioned, in which a small body of cavalry gave useful assistance in the advance on High Wood."

Aerial Operations Independent of Land-Forces

Aerial operations independent of the land-forces are increasing in number and extent. The advent of large battleplanes with a flying radius of close to 1000 miles, and capable of carrying one ton or more of explosives, will increase the extent of bombing operations.

It is, roughly, between 450 and 500 miles from Great Britain to Kiel, Wilhelmshaven, and Helgoland. It is less than 300 miles from the Allies' lines to Essen and Düsseldorf, and it is less than 100 miles from the main Allied aeronautic bases to Zeebrugge and Ostend, which are important bases for U-boats and German destroyers.

Details regarding the types of warplanes used for bombing and major operations are given in the chapter on "The Warplane for Bombing and Torpedo Attacks."

Coöperation Between the Army and the Navy in Conducting Major Operations

As pointed out in the "Textbook of Naval Aeronautics," it is difficult to define the lines of demarcation where the navy ceases to operate

and the army begins to operate, and vice versa. The Allies have, very wisely, combined their aerial resources to conduct major aerial operations.

It would be hard to figure out under whose jurisdiction a raid should be conducted which involves flying over land and sea; therefore all lines of demarcation have been wiped out in so far as major operations are concerned, the bombing squadrons usually including army and naval aviators of two or three of the allied nations. It is to be expected, therefore, that army aviators will be called upon to participate in operations in which their aeroplanes will carry torpedoes, to be used in attacks against the German fleet, just as naval aviators have been called upon to conduct bombing operations against German military bases, as in the case of the raids on Essen and Obendorf.

In the United States the army has charge of the coast defense; therefore the army air service uses land and water aeroplanes, airships, and captive balloons.

The functions of aircraft for coast defense are:

(1) For reconnaissance, patrolling the coasts, looking for hostile ships of all types, enemy sub-



A French Nieuport fighting aeroplane photographed as it was passing another military aeroplane in midair.

marine bases, and mines. Aeroplanes, large and small, land and water, and dirigibles are used.

(2) To prevent the landing of enemy forces by attacking the hostile ships and transports with torpedoes, guns of large caliber, and bombs. Aeroplanes, land and water, and dirigibles are used.

(3) To attack hostile bombarding and blockading ships with torpedoes, guns, and bombs. Aeroplanes, land and water, and dirigibles are used.

(4) To direct and spot the fire of coast defense batteries. Aeroplanes, land and water, dirigibles, and captive balloons are used.

(5) To fight off enemy aircraft, preventing

them from gathering and transmitting information about the location and disposition of our coast defenses. Aeroplanes and dirigibles are used.

(6) To transmit confidential information between military stations. Aeroplanes and dirigibles are used.

(7) To convoy troopships, merchantships and army transports on coastwise trips. Aeroplanes, land and water, and dirigibles are used.

(8) To locate mine-fields and assist trawlers in destroying mines. Aeroplanes, dirigibles, and captive balloons are used.

(9) To serve as the "eyes" in planting mines. Captive balloons, dirigibles, and aeroplanes are used.



The effect of a bomb dropped on an aerodrome at Salonica by a German aeroplane. It just missed hitting the hangars and garage.

CHAPTER II

THE WARPLANE FOR BOMBING AND TORPEDO ATTACKS

The New Revolutionary Weapon Which Combines Power, Mobility, and Control, and Permits Major Aerial Operations Against German Military Centers and Naval Bases

It is generally agreed that the most effective and quickest way of achieving victories of decisive importance over Germany is:

(1) By conducting substantial bombing operations against German military centers, military supply bases, and railroads;

(2) By conducting substantial aerial operations against the German fleet and U-boat bases, striking the German fleet with torpedoes launched from torpedoplanes and the U-boats and the bases with bombs dropped from the air, as well as with shots from aeroplane guns of large caliber.

Such major aerial operations, supported by energetic military operations on land, and naval operations at sea, could, as Admiral Fiske has pointed out repeatedly, in a comparatively brief period of time destroy Germany's strength as nothing else can. They could do more than the addition of a million men on land and five naval squadrons at sea, because, as it is gener-

ally admitted, additional men could do but little against the entrenched German lines. Capturing lines at present involves going through many lines of trenches, and that involves lengthy preparatory activities.

The same thing is true at sea; ships and men can do but little against the entrenched German fleet, because of the miles of mines and other defenses which protect the German fleet.

As Admiral Fiske has pointed out in the "Textbook of Naval Aeronautics," the large warplane combines power, mobility and control as no other weapon does, and permits the quick concentration on any given point of large masses of explosives.

Aircraft can fly over all obstructions, both in the sea and on the land, as though they did not exist. True, during daylight, squadrons of German battleplanes and hundreds of German anti-aircraft guns would attempt to prevent the progress of the Allies' raiding forces, which

would involve casualties—although only a fraction of the casualties that result every day in the least important land operations.

Night Raids Can Be Conducted Without Difficulty

A thousand aeroplanes could fly from the nearest Allied bases to the German bases at Kiel and Wilhelmshaven, or to Essen, Berlin, and other German military centers, almost unseen.

At night aeroplanes can hardly be seen a hundred feet away by other aeroplanes, and it is a most difficult thing for searchlights to locate them in the sky. Under the best weather conditions and a fairly clear night, a squadron of Allied aeroplanes started from Salonica recently to bomb the German lines. They arrived over the German lines, and were surprised when all at once the lights of the German aerodrome were lighted. The Allied aviators dropped their bombs and returned to their own aerodrome—to find that German aviators had in the meantime bombed the Allied lines. The squadrons had passed each other en route, but neither side had sighted the other. In each case the officers in charge of the aerodromes lighted the aerodromes when they heard the noise of motors, thinking that their aviators were returning from their bombing raid. In scores of cases single aeroplanes or fleets of five

or more aeroplanes have carried on bombing raids during the night without being seen by Germans. Therefore, the solution of striking Germany through the air rests in night raids.

Allies Have Never Had Enough Large Aeroplanes with Which to Conduct Major Aerial Operations

Neither the Allies nor the Teutons have had a sufficient number of large aeroplanes to permit them to conduct major aerial operations against the other side. While there are now thousands of aeroplanes employed, whereas there were only a few hundred in the beginning of the war, the use of aeroplanes has been so greatly extended, and they are used for so many important purposes in connection with military, coast patrol, and naval operations, that it has been impossible to accumulate the number of aeroplanes required for major aerial operations.

It is also true that until recently there were not available the types of large aeroplanes required for long distance bombing or torpedo launching operations.

Huge Warplanes to Do at Long Range What Huge Guns Can Only Do at Short Range

Major R. Perfetti, the head of the Special Italian Commission for Aeronautics in the United States, brought to the attention of the



The German Gotha warplane.



When the "Emergency Air Fleet" Crosses the Rhine!

Allied military authorities the fact that huge warplanes can do at long range what huge guns can only do at short range. He pointed out that, just as reducing the fortresses and positions which were supposed to be invulnerable was done by concentration of the fire of many huge guns, the reducing of distant military and naval bases can be accomplished by the dropping of tons of explosives simultaneously by hundreds of warplanes.

This was an obvious truth, which heretofore could only be figured out theoretically, but not proven in practice, because of the lack of warplanes powerful enough to carry tons of explosives. Major Perfetti could state it as a tested and proven truth, because Italy has the huge warplanes needed for these operations, and has

been using them on a limited scale in her operations against the Austrians over the mountains and across the Adriatic Sea.

If the United States takes steps promptly to build thousands of these huge triplanes, it is possible that substantial deliveries will begin to be made in six months, making it possible to figure on aerial operations against the German naval and military bases next spring and summer. Nothing else affords such possibilities.

Proportion of Bombing Planes to Be Increased

Heretofore, owing to limited production, the proportion of bombing planes to the number of aeroplanes used has been only about ten per cent. Twenty per cent. have been small, fast



A British aviator throwing a bomb.

fighting machines to fight enemy aviators engaged in similar work, or in photographing, directing artillery fire, reconnoitering, etc.

Now that the United States has entered the war, and has mobilized manufacturing resources to the point where a program to manufacture 100,000 aeroplanes could be completed in three years, the proportion of bombing planes can be increased by the addition of thousands of huge bombing warplanes, many of which can be manufactured in America, the Italian Government, like the British and French Governments, having offered to cooperate with the United States Government.

Huge Warplanes and Torpedoplanes Capable of Carrying Tons of Explosives

The Allies now have huge warplanes and torpedoplanes capable of carrying from two to three tons of explosives or torpedoes. The

gigantic Caproni torpedoplanes permit aerial operations from any of the Allied bases to any German naval or military base and return—with substantial reserve fuel.

The Curtiss triplane air-cruiser, while handicapped by the heavy flying-boat hull, is also a good possibility. The twin-motored Handley-Page biplane and the new three-motored Gallandet seaplane are among other possibilities for long-distance aerial raids.

The Marvelous Giant Caproni Warplane

Italy leads in types of bombing and gun-carrying aeroplanes.

The following are some of the most important types of Italian aeroplanes, types which, if built by thousands, will make it possible for the Allies to conduct the major aerial operation against Germany which is to ensure her downfall:

(1) The largest Caproni triplane. This remarkable warplane is equipped with three large h.p. Fiat motors. The details about this machine are kept secret, but it is known that the machine, as a whole, follows the characteristics of the Caproni warplanes. This machine, judged by the smaller types, must carry about five tons of explosives and fuel for twelve hours, at a speed of about eighty miles an hour.

(2) The small bombing type Caproni triplane. This machine, which is illustrated herewith, is a triplane, with two fuselages, equipped with three Fiat or Isotta-Fraschini motors, two in front fitted with one propeller respectively, and one in the rear, also fitted with one propeller. Each of the engines is independent of



Italian Battleplanes. From left to right: the Caproni triplane, equipped with three Fiat motors.

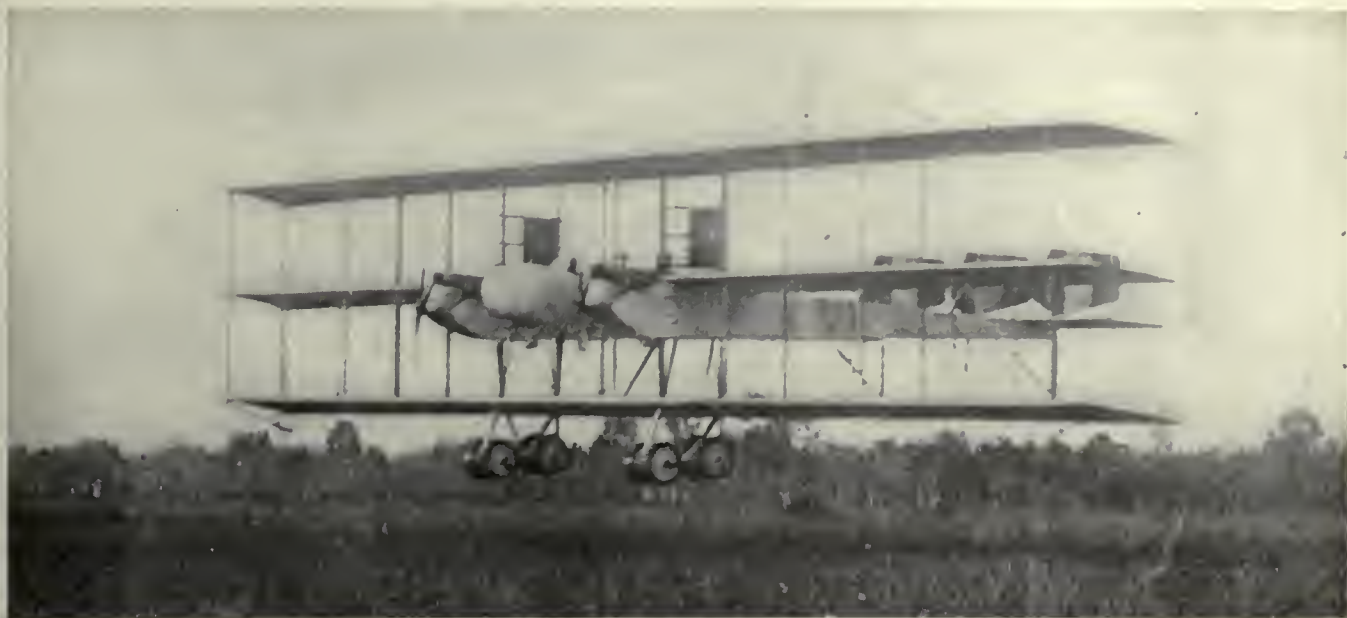

The Italian Caproni warplane returning from a flight.

the others, so that if two of the engines should stop, the machine could still keep in the air with the power of one motor.

(3) The bombing type Caproni biplane. This type of machine is most remarkable for its speed. It is equipped with three Fiat or Isotta-Fraschini motors of 200 h.p., and three propellers, two tractor and one pusher.

French and British Bomb-Dropping Machines

The following are a few of the many French and British bomb-dropping, gun-carrying machines:

The British Handley Page, equipped with two Rolls-Royce motors. This biplane has

carried 21 passengers in one flight and has a top wing-spread of 98 ft. and a lower wing of 98 ft. It has mountings for large guns.

The twin-motored Avro biplane, a triplane equipped with various kinds of motors.

In the "short distance" class of bombers are: The Sopwith 130 h.p. triplane known as the "Tripe Hound." This is a single seater equipped with a Clerget motor.

The two seater $1\frac{1}{2}$ strut Sopwith biplane equipped with a Clerget motor. This is used extensively by the Royal Naval Air Service for bombing, and the Royal Flying Corps for fighting.

To these must be added the machines designed by the Royal Aircraft Manufactory, which include the BE-2C, R. A. F. motor, rather



Caproni biplane: the small Italian fighting Monoplane, and the Caproni bombing biplane.

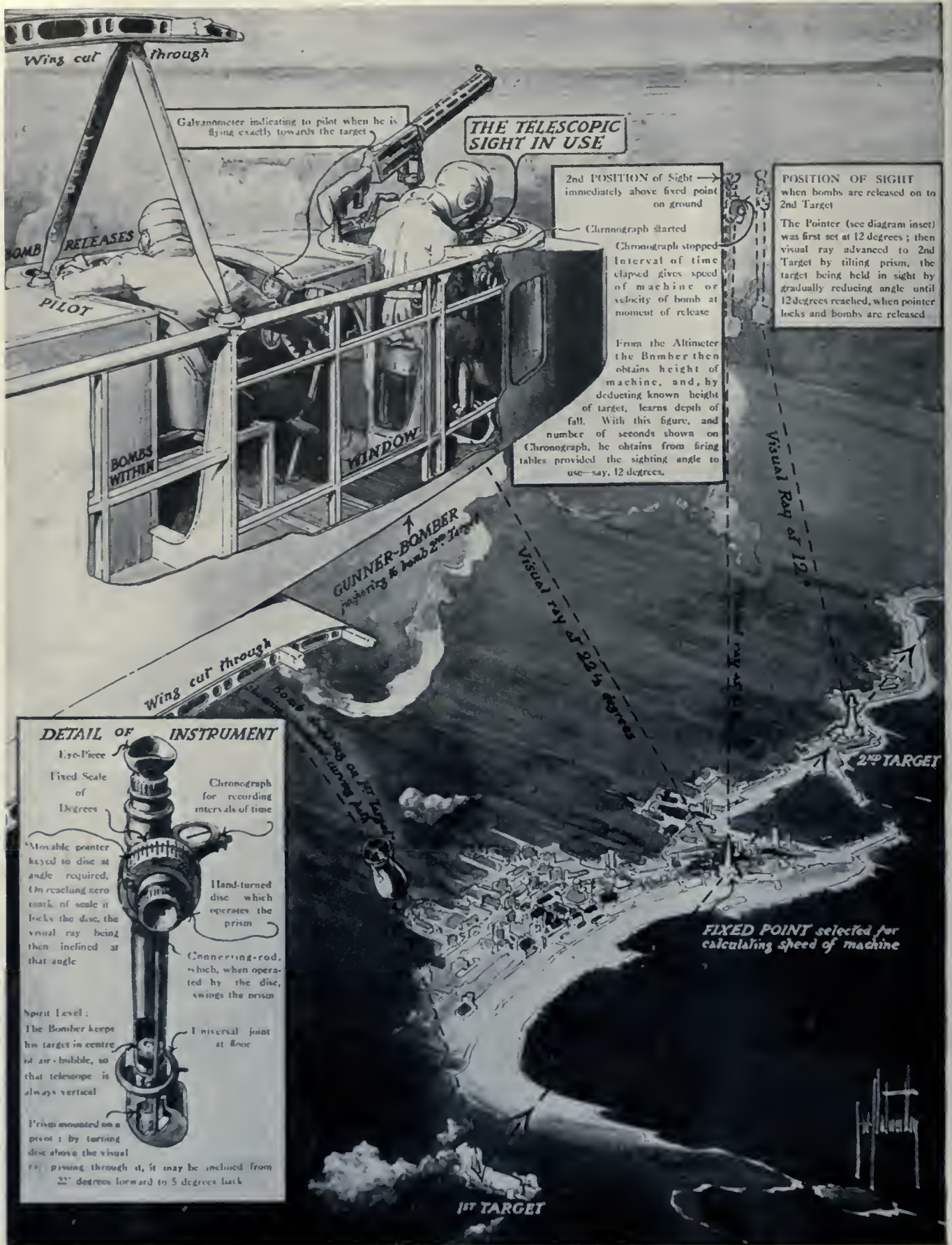

DRAWING FROM THE LONDON GRAPHIC SHOWING HOW THE GOTHIA AIMS ITS BOMBS

The art of aerial bombardment is largely a matter of luck. To reduce this element the enemy has produced the instrument illustrated, the Goetz bomb-dropper's telescopic sight, which is included in the equipment of the Gotha, which has a speed of ninety-three miles an hour, therefore makes accurate hitting difficult.



British airmen taking the offensive against a German brigade concentrating for attack near Arras. The aviators discovered the Germans concentrating for an attack and dropped heavy bombs on them, destroying their machine guns and ammunition and dispersing them. In addition, the aviators advised the British artillery which opened fire on the German concentration, so that the German attack was never even launched.—(Drawing by the "Illustrated London News" artist.)

slow and a poor climber, but a good machine for night flying, on account of its inherent stability; the BE-2E, the FE, which is a two-seater pusher fighting machine; which is a faster scout, just being tested, and the BE-12. Also the two-passenger Avro, armed with one or two guns.

The French also use a great many different types of machines, the following being used for bomb-dropping:

The *Breguet*, equipped with a single motor.

The *Caudron G-4*, pilot and observer; equipped with two La Rhone motors.

The *Caudron G-6*, two-passenger; equipped with two La Rhone motors.

The *Dorand A-R*, two-passenger; equipped with one motor.

The *Farman*, pusher type, two-passenger; equipped with 170 h.p. Renault motor, carrying one or two Lewis guns forward.

The *Letort*, equipped with two motors.

The *Moineau*, three-passenger; one motor, connected to drive two propellers.

The *Voisin-Peugeot*, two-passenger; equipped with a Peugeot motor.

The *Caudron R-4*, three-passenger.

The *Farman*, pusher type, two-passenger, equipped with one Renault motor.

The Germans have several types of bombing machines, of which the Gotha is most prominent. It is a biplane equipped with two 260 h.p. Mercedes motors, carries fourteen bombs, and is armed with three guns.

The Huge Curtiss Triplane

The huge Curtiss triplane air-cruiser built for the British Government is a good possibility as a long-distance bomb carrier, for aerial operations against Germany. For such a purpose the boat-hull can be eliminated, and its weight-carrying ability increased thereby. Having multiple power-plants, it can make the flight from an Allied base to Kiel or Berlin or Essen with a good margin of flying ability.

The big Curtiss triplane, with a few changes in construction, will make a most efficient torpedoplane, capable of carrying a magazine of torpedoes.

The new three-motored Gallaudet seaplane



The Twin-Motored Handley Page Bombing Biplane. A Handley Page has flown from London to Asia Minor, with stops, and dropped bombs on Constantinople. It carried seven men, spare motors and supplies. Larger Handley Pages can fly across the Atlantic and bomb the German bases and munition plants.



The French Farman machine equipped with a Dietrich motor, used extensively for bombing.

also comes in the class of long-distance raiding machines and is suitable for either bomb-dropping or torpedo-launching. A number of other large machines are under contemplation or are being designed by different American manufacturers, but the details are not yet available.

Long-Distance Bombing Raids Not New

Long-distance bombing raids are by no means a novelty, but they have always been conducted with only a few aeroplanes of limited carrying capacity, which carried only a few hundred pounds of bombs besides the fuel needed for the journey.

Among the historic bombing raids, for several reasons, is the raid on Karlsruhe, on June 15, 1915. It was conducted by twenty-three twin-motored Caudron machines in charge of Captain de Kerillis, and dropped close to 50 large bombs on Karlsruhe. Three of the machines did not return; they had to land and were captured, but the damage to Karlsruhe was serious.

In the very first bombardment of Sofia, on April 21, 1916, a single aviator started from Salonica, flew to Sofia, dropped four bombs and proclamations announcing the capture of Trebizond, and returned to Salonica. This exploit was repeated by single aviators from time to time; then on September 15, 1916, it was repeated by four aviators who left Salonica at 6:20 and arrived over Sofia at 8:40. They dropped their bombs, many of which were effective, and returned. They had crossed the Balkan Mountains at 6000 feet without trouble and had accomplished what an army could not have done. The only limitation was that the aeroplanes were too few in number to win a decisive victory. In every raid in the Balkans only four or five aeroplanes participated.

Among the most remarkable long-distance bombing raids were the raids on Essen and Munich by Captain de Beauchamp and Lieutenant Daucourt, on September 24 and November 18, 1916, which have been repeated since by other aviators. The raid on Ludwigshafen, accomplished on May 27, 1915, in which 18 aeroplanes took part, also involved a flight of about



Plotting a Bombing Raid.



Plan of Kiel and Kiel Canal from Count de Beaufort's book, "Behind the German Veil." The author points out that Kiel is derived from the Anglo-Saxon "Kille," meaning "a safe place for ships." The torpedoplane will make it unsafe for ships to be there.

400 miles. It was conducted successfully, and only one aeroplane was forced to land and was captured. Another classic flight was the bombing raid on the Mauser Works at Oberndorf, on October 12, 1916, in which a French bombing squadron and a British bombing squadron participated, escorted by the Lafayette Flying Corps fighters. These are only a few of scores of such raids. In all these raids the aviators had to fly from five to seven hours continuously

under most trying conditions, having to protect themselves with insufficient arms. A night raid in large, well-armed warplanes would be easy in comparison—and much safer.

Long-Distance Allied Raids into Enemy Country in the Western Theater of War

The following list of the most important French and British raids in 1916, together with twenty-five important Italian raids, compiled by London "Aeronautics," is reproduced herewith for reference purposes:

- MARCH 20—Fifty British, French, and Belgian aeroplanes attack Zeebrugge and Houttade.
- MARCH 25—Naval raid on airship sheds in Schleswig-Holstein.
- APRIL 3—Reprisal raid by 31 Allied aircraft on enemy cantonments of Keyem, Essen, Terrest, and Houthulst.
- APRIL 23—Naval air raid on Mariakerke.
- APRIL 24—Anglo-Belgian raid on Mariakerke.
- JUNE 21-22—French drop 18 bombs on Treves.
- JUNE 22—Nine French aeroplanes bomb Karlsruhe, and ten bombard Mülheim (Rhine) as a reprisal for the bombardment of Bar-le-Duc and Lunéville.
- JULY 13—French aeroplane carries out night raid on Mülheim as a reprisal for the bombardment of Lunéville.
- JULY 19-20—French aeroplanes bombard military establishments of Lorrach (Baden).
- JULY 22—Twelve French aeroplanes bombard the military establishments of Mülheim.
- JULY 30—Naval raid in conjunction with the French on benzine stores and barracks at Mülheim (Alsace).
- AUGUST 2—Naval air raid on St. Denis Westrem and Mierelbeke.
- AUGUST 8—First night raid by Adjutants Baron and Emmanuelli on powder factory at Rottweil, on the Neckar.
- AUGUST 9—Naval attack on airship shed at Evère.
- AUGUST 18—Naval aeroplanes bomb enemy ammunition dumps at Lichtervelde.
- AUGUST 25—Naval aeroplanes attack airship sheds near Namur.
- SEPTEMBER 2—Naval aeroplanes bomb shipbuilding yards at Hoboken, near Antwerp.
- SEPTEMBER 3—Large squadron of naval machines bombard enemy aerodrome at Ghisteltes.
- SEPTEMBER 7—Attack on enemy aerodrome at St. Denis Westrem carried out by naval aeroplanes.
- SEPTEMBER 9—Naval aeroplanes attack Ghisteltes and Handzaeme aerodromes and also the ammunition dump at Lichtervelde.
- SEPTEMBER 9-10—Second night raid by Adjutants Baron and Emmanuelli on powder factory at Rottweil.
- SEPTEMBER 14-15—French squadrons bombard by night works at Rombach and Dillingen.
- SEPTEMBER 15—Naval aeroplanes bombard batteries at Ostend.
- SEPTEMBER 17—Further naval raid on St. Denis Westrem aerodrome.
- SEPTEMBER 22—Enemy aerodrome at St. Denis Westrem again bombed by naval aeroplanes.
- SEPTEMBER 23—Adjutant Baron bombards by night military establishments at Ludwigshafen, and continuing his route, bombs Mannheim.
- SEPTEMBER 24—Captain de Beauchamp and Lieutenant Daucourt bomb the factories of Essen (Westphalia).
- SEPTEMBER 24-25—French bombarding squadrons effect by night an attack on the blast furnaces of Dillingen (Rhineland) and Saarlouis.
- SEPTEMBER 27—Naval raid on airship sheds at Evère, Berchem St. Agathe, and Etterbeck.
- OCTOBER 5—French bombard aviation ground at Colmar (Alsace).

Night raid by French aeroplanes on electric searchlights and buildings at Zeebrugge.

OCTOBER 9-10—Adjutants Baron and Chazard bombard by night the Bosch magneto factory at Stuttgart.

OCTOBER 10-11—French night raid on Lorrach establishment, Colmar aviation ground, and Mulheim railway station.

OCTOBER 12—Franco-British squadron of 40 aeroplanes bombard the Mauser works at Oberndorf.

OCTOBER 22—French aeroplanes bombard blast furnaces of Hagondange.

OCTOBER 23—British aeroplanes carry out a further attack on Hagondange.

NOVEMBER 9—French aviator bombs railway station of Ofenburg.

NOVEMBER 10—Naval raid on Zeebrugge Ostend. Seventeen British aeroplanes bombard the steel works of Frocklingen (northwest of Sarrebruck) and other factories in the Sarr region.

NOVEMBER 10-11—Further night attack by French aeroplanes on same factories.

NOVEMBER 12—A squadron of naval aeroplanes carry out an attack on Ostend harbor.

NOVEMBER 15—Further naval attack on harbor and submarine shelters at Ostend and Zeebrugge.

NOVEMBER 17—Successful raid on Ostend and Zeebrugge by naval aeroplanes.

Captain de Beauchamp bombs Munich as a reprisal for the bombardments of Amiens.

NOVEMBER 22—Naval aviators drop bombs on torpedo craft and seaplane sheds at Zeebrugge.

NOVEMBER 23-24—French aviators again bombard Völklingen blast furnaces.

NOVEMBER 24—British naval aeroplanes bombard the blast furnaces of Dillingen.

NOVEMBER 28—Naval aeroplanes carry out an attack on Zeebrugge harbor.

DECEMBER 27—Thirteen machines of the R.N.A.S. bombard blast furnaces at Dillingen.

French dirigible bombards factories at Hagondange and iron-works at Neunkirchen.

SEPTEMBER 26—Russian aviators again attack German air-station on Lake Angern.

DECEMBER 13—Successful Russian air-raid on Tarnopol-Zloczow railway.

Italian Theater

JANUARY 14—Italian air squadron bombards Aisovizza aerodrome.

JANUARY 17—Italian aviator bombs Austrian headquarters at Volano.

FEBRUARY 12—Austrian seaplanes raid on Ravenna.

FEBRUARY 18—Italian machines carry out reprisal raid on Laibach.

APRIL 3—Italian aeroplanes bomb railway at Adelsberg.

APRIL 17—Franco-Italian raid on Trieste.

APRIL 20—Italian air-raid on Trieste.

MAY 3—Italian airship falls into Austrian hands.

MAY 7—Italian air-raid over the Adige Valley.

JUNE 3—Italian squadrons bomb encampments in the Astico valley.

JUNE 12—Italian seaplanes bomb Trieste.

JUNE 16—Italian squadron of thirty-seven machines bomb encampments in the Nos Valley.

AUGUST 1—Italian squadrons bombard the Whitehead Torpedo and Submarine Works at Fiume.

AUGUST 2—Italian aviators bomb Durazzo.

AUGUST 15—Italian Nieuport chasers bomb Austrian encampments near Gorizia.

AUGUST 16—Italian aviators bomb railway at Reinenberg.

AUGUST 25—Italian air-squadron bombs railway-station at San Cristoforo.

SEPTEMBER 13—Italian machines bomb Trieste.

SEPTEMBER 15—Italian squadrons bomb Comignano.

SEPTEMBER 17—Italian squadrons bomb station at Dottogliano and Scoppo.

OCTOBER 31—Italian squadrons successfully bomb Trieste railway.

NOVEMBER 1—Italian Nieuport-Caproni squadron bombs enemy camps in the Vippacco Valley.

NOVEMBER 7—Franco-Italian aircraft carry out raid on the Istrian coast.

NOVEMBER 14-15—Italian aviators attack airsheds at Prosecco and the pier at Trieste.

DECEMBER 30—Italian raid on Volano and Rifemberga.

DECEMBER 3—Italian aviators attack Dottogliano and Scoppo railway stations.

Southeastern Theater

JANUARY 23—Thirty-two French aeroplanes bomb Ghevveli and Monastir.

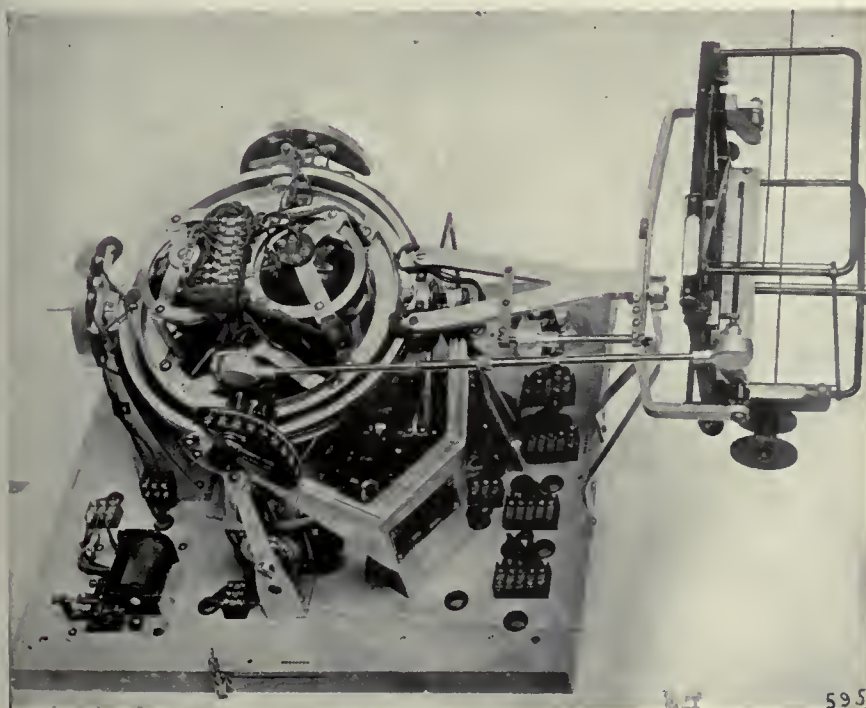

One of the three Sperry bomb sights. The Sperrys, after gaining world-wide fame in making scientific instruments for ships, undertook to solve the most difficult problems in aerial navigation and aerial warfare. Having begun in the early days of aeronautics they were able, through their long experience in aeronautics, and thorough knowledge of the problems, to evolve some most efficient instruments.

JANUARY 28—Fourteen French aeroplanes bomb Bulgar camp northwest of Lake Doiran.
 MAY 24—Allied raid on Ghevgeci.
 JULY 3—Allied aeroplane drops bombs on Sofia.
 AUGUST 18—Nineteen Allied aeroplanes attack Monastir.
 AUGUST 25—Russian seaplanes bombard Varna.
 AUGUST 25-31—Naval air raids behind Kavala.
 AUGUST 28—French aviators destroy aviation park at Mrzenci.
 AUGUST 29—English aeroplanes bomb Drama.
 SEPTEMBER 2—Raid on Constanza.
 SEPTEMBER 9—Rumanian aviators bomb Rustchuk.
 SEPTEMBER 13-22—Naval seaplanes bomb Bulgarian coasts.
 SEPTEMBER 14—French aviators bomb Sofia.
 SEPTEMBER 18—English aviators drop bombs on Prosenik.
 SEPTEMBER 26—The R.N.A.S. bomb Angista.
 OCTOBER 11—French aviators bomb Prilep.
 OCTOBER 15—R.N.A.S. bomb the Buk bridge.
 OCTOBER 23—Naval aeroplanes bomb Buk and Drama.
 OCTOBER 26-27—English aviators reach Bucharest.
 OCTOBER 28—News of the evacuation of Constanza carried to Odessa by seaplane.
 OCTOBER 31—Naval aircraft bomb railway bridge at Simsirli.
 NOVEMBER 3—English aviators bomb Bursuk.
 NOVEMBER 11—Naval aircraft bomb Seres-Draima railway. Bombs dropped on Campulung.
 NOVEMBER 18—British squadrons bombard Karjani, Pravishta, and Senultos.
 NOVEMBER 22—French aeroplanes bomb enemy encampments in the Topolchani and Prilep regions.
 NOVEMBER 23-28—Naval squadrons bomb Bulgarian coast.
 NOVEMBER 29—British naval aeroplanes effect great damage at Gereviz.
 DECEMBER 4—Russian air raid near Constanza.
 DECEMBER 14—Naval air squadron bombs Kuleli-Burgas bridge, on the railway to Constantinople.

The Levant

FEBRUARY 20—English aviator destroys enemy's power station at El Hessana.
 APRIL 12—English bomb Smyrna.
 APRIL 14—British naval aeroplanes bomb Constantinople.
 MAY 18—English machines bombard El Arish.
 MAY 25—The R.F.C. bomb advanced posts in Sinai Desert.
 MAY 29—English drop more bombs on Smyrna.

JUNE 13—The R.F.C. bomb El Arish.
 AUGUST 25-29—English aviators carry out many raids in Palestine.
 SEPTEMBER 4—R.F.C. bomb Mazar.
 SEPTEMBER 5—English aviators bomb Turkish aerodrome at El Arish.
 OCTOBER 1—English bombs dropped on Kut-el-Amara.
 OCTOBER 10—R.F.C. bombs Tigris camp.
 NOVEMBER 1—Russian aviators carry out successful raid on the Euphrates.
 NOVEMBER 11—English aviators carry out two successful raids on Maghdaba and Birsaba.
 NOVEMBER 15—English aviators bomb Turkish base near Sinai.
 DECEMBER 4—English aviators carry out reprisal on Turkish camps.
 DECEMBER 14-15—British aviators attack Tigris pontoon bridges by night.

Aeroplane Raids on England, 1916

Date	District	Casualties	
		Killed	Injured
JAN. 23	East Coast of Kent.....	1	6
FEB. 20	East and Southeast Coasts—Lowestoft and Walmer	3	7
MAR. 1	Southeast Coast	1	—
19	East Kent—Dover and Ramsgate	9	31
APRIL 24	Dover	—	—
MAY 3	Deal	—	1
20	East Coast of Kent	1	2
AUG. 12	Dover	—	7
OCT. 22	Sheerness	—	—
23	Margate	—	2
	Total	15	59
Nov. 28	London	—	9

Extensive Damage Can Be Done by Bombs

The damage that can be done by bombs is extensive, particularly in thickly settled places. In fast raids, whole factories and magazines

Incendiary bombs dropped on English soil by Zeppelins, some burned out and some still active.





The French Bréguet Michelin warplane, equipped with one 220 horse-power Peugeot motor. This machine is used extensively for bombing.

have been blown up, railroad stations wiped out, bridges wrecked, hangars and dirigibles destroyed, ships destroyed in their docks, and military camps and billets destroyed.

The damage has been considerable, even when only a few aeroplanes were employed. The employment of hundreds of aeroplanes would wreck entire military and naval bases. A fleet of hundreds of torpedoplanes, cooperating with bomb-dropping planes, could attack the German fleet at its base from every side, as well as from above, and inflict tremendous damage, if not destroy it completely. It depends entirely upon the number of aeroplanes employed, and whereas a fleet of hundreds of torpedoplanes and bombing aeroplanes would cost far less than a naval squadron, and could be built and operated much quicker—it could strike at the German fleet, whereas a naval squadron could not—it is evident that aeronautics affords the quickest and most effective way to strike the German fleet, the U-boat bases, and the German military centers. It is the opinion of leading strategists that such extensive aerial operations, combined with naval operations, could reduce the most impregnable naval bases.

Night Facilitates Bombing at Close Range

Night facilitates bombing at very close range. The aviator can fly close to his target and hit it in the most vulnerable points.

The first part of aerial attack can be carried

out by surprise, and half of the work is done before the searchlights and anti-aircraft guns are put in operation. In a raid of hundreds of aeroplanes the searchlights and anti-aircraft guns could not cope with the situation. Any plan to prepare all the naval and military bases so as to have sufficient anti-aircraft defenses to cope with the situation would involve employing tens of thousands of gunners and their personnel, withdrawing them from the fronts, and thereby weakening the German lines.

If the night should happen to be extremely dark, the aeroplanes could light up the area to be bombarded by dropping parachute flares.

Need of Silencers to Eliminate Noise of Approach

Silencers are needed on aeroplane engines to eliminate the noise of approach, which is the only thing that warns the enemy of the approaching warplanes at night. The silencers must do their work thoroughly, eliminating the exhaust sounds entirely, because the anti-aircraft units have very powerful microphones that magnify the slightest sound.

Lacking silencers—for no reason other than the added weight and slight loss of power—raiding aeroplanes are forced to fly at high altitudes in an attempt to escape detection. The weight of the fuel needed, and the horse-power and time spent in evading detection in this way, represents really a greater loss of efficiency than the loss caused by the silencers.

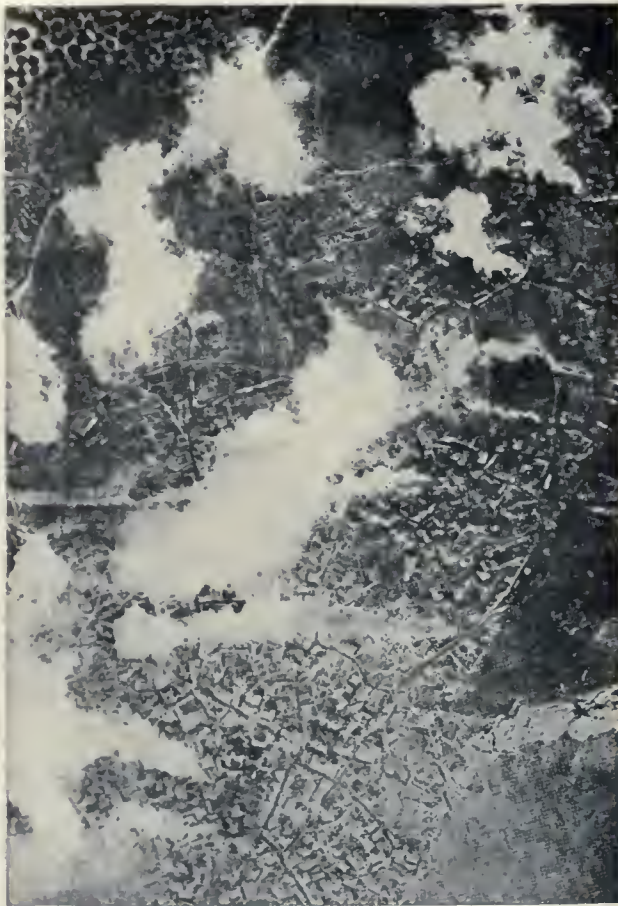

Monastir, photographed by a French aviator while under fire.

Bombs and Bomb-Holding Gears

The following types of bombs are in use: 16-pound bombs, 56-pound, and 100- and 112-pound bombs. In some cases there are bombs weighing 500 pounds or more.

The 16-pound bombs are usually arranged in series of four under the fuselage. The releasing gear is worked from a bowden wire which actuates a bar releasing the bombs in the following order: 1, 4, 2, 3, which avoids unequal distribution of weight. The 56-pound bombs are usually carried in a series of two, and are released in the same fashion. The 100-pound and 112-pound bombs are always carried in single bomb-frames. These have two levers, one to fuse the bomb and the other for releasement. These bomb-frames are usually slung on either side of the fuselage below the lower plane, and aft of the axle. In all the above cases the bomb is held horizontally in a fore-and-aft position, the nose of the bomb pointing forward.

In all the latest types of machines the bombs

are carried in a vertical position inside the body of the aeroplane, nose downward. This is a very great saving of head resistance. For obvious reasons it would be inadvisable to give details of these bomb-dropping devices, which permit the aviator to drop one or all of the bombs simultaneously.

Dropping bombs weighing 500 pounds or more is not difficult; heretofore it has been more difficult to get large aeroplanes capable of carrying them. Now that large warplanes are coming into use in quantities, the dropping of bombs weighing 500 pounds or more will be common, likewise the launching of torpedoes weighing from 200 to 1500 pounds.

Bomb-dropping with dirigibles differs little from dropping bombs from aeroplanes, excepting that whereas the dirigible makes such a large target, and moves much slower than the aeroplane, it cannot come as low as the aeroplane to drop the bombs. On the other hand a Zeppelin can carry three or more tons of explosives and can remain in the air forty hours continuously.

Zeppelin Bomb-Dropping Mechanism

The bomb-dropping mechanism of a Zeppelin captured by the British was described in a recent number of the *London Sphere*. There are sixty bomb-droppers for conical bombs. The base is slung in straps, and there is a strap around the neck. The latter has a releasing hook, and when the releasing hook is operated, the small end first drops down and the base slides out of its straps. The bomb then rights itself and drops base downward. The bombs are slung in one or two lines along the under side of the hull. The releasing hook is operated by an electro-magnet, and there is a small switchboard in the cabin for controlling the release. Each bomb has a separate switch. The bombs can be released by hand levers also, in case the electric power should fail. Each bomb has a safety device and is not "alive" until it has dropped several hundred feet.

Bomb Sights—The Scientific Side of Bomb-Dropping

Bomb-dropping from heights can only be approximately accurate. It can be made more ac-



Getting ready to deliver a load of bombs to Germany. Adjutant Maneval, of the French Air Service, has painted on his aeroplane the following, "General Transport Agency—Rapid Service—Delivered at home!" (Official photo.)

curate by the employment of efficient bomb sights.

A few of the older aviators have learned by long practice to drop bombs accurately without sights, but as a general rule one can be more accurate with the sight than without it. There are a number of highly ingenious bomb sights used by aviators.

Night-Bombing Requires Knowledge of Aerial Navigation by Instruments

Night-bombing requires considerable technical knowledge and much actual experience of aerial navigation if it is to be effective. It is important that the use of navigating instruments be familiar, and the success of the work depends obviously upon accuracy.



One of the hundreds of munition depots which must be protected from enemy bombs.

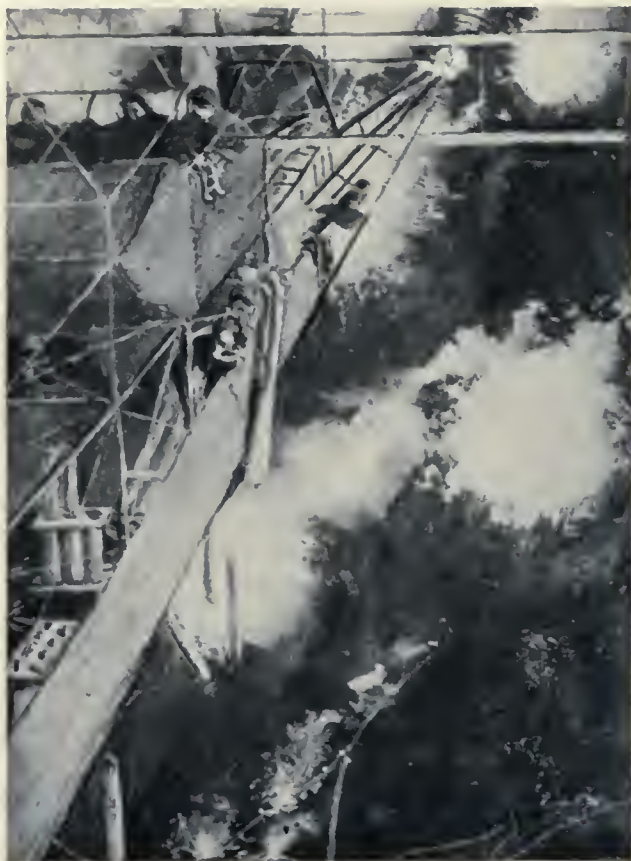

Dropping bombs from a French airship at night, depicted by a French artist.

The instruments used in the British Naval Air Service for night-bombing are:

Compass—Before starting, the wind-force and direction are taken. Taking into consideration the height at which the pilot will fly, the course is plotted, and the pilot then has the course which he will steer by his compass. Also he has the course he will steer coming home.

Air-Speed Indicator, or Meter—This is essential because the pilot will throttle down his engine in order to spare it, and it is essential that he should know his speed, so that he can calculate by the aid of his clock at what time he may expect to be over his objective.

Spirit-Level, or Lateral Inclinator—This is an exceptionally useful little instrument, for as long as the bubble remains in the center the pilot knows that he is handling his controls in the correct manner, even though he be on a vertical bank.

Inclinator—This instrument gives the position of the machine fore-and-aft, and is quite useful, as it enables the pilot to determine the

angle at which his machine is either diving or climbing, or whether he is flying level.

Altimeter—An accurate altimeter is important. This will indicate to the pilot the height above sea-level, and a pilot flying at night should be well acquainted with the height above sea-level of all surrounding country, particularly any aerodrome upon which he may be forced to land.

Night Landing-Lights

In England during the early days of Zeppelin raids, the casualties resulting to pilots who went up at night to attack Zeppelins was very high. This was mainly due to two things: (1) An insufficient number of badly lighted night-landing grounds; (2) Lack of lighting devices on the machines.

These conditions resulted in a tremendous handicap to British pilots. Being out in the sky at night is worse than being out in a small boat at night. In moonlight one can pick out places, but without moonlight flying is difficult. The safest way is to use a double-motored machine. Then there is no necessity for hasty landing if one of the motors develops trouble. Nor must the pilot forget the recognition signal which he must flash when he wants to land. This signal is changed each day.

In addition to the Verys pistol, night flying-machines are specially equipped with a parachute flare. This is fired electrically from the pilot's seat, through a tube. On release, the electric connection is made, and the flare, unfolding a couple of hundred feet, explodes, releasing a small silk parachute with a very bright light attached. This illuminates the country for a radius of approximately a quarter of a mile, and gives the pilot a chance to select a desirable landing-ground. In addition to this, there are attached to the machine:

(1) *Holt's Landing-Lights*—These are flares attached to the underside of the wing-tips, and ignited electrically. Upon connection being made, these ignite, throwing a very strong light downward. This is reflected downward by the wings, and so does not dazzle the pilot, and if the ground is practicable for landing, he may easily make a perfectly good forced landing.

(2) *Electric Headlights*—these are not arranged the same way on all machines. Some have a single light slung just underneath the fuselage, and others have one on each wing-tip. These lamps are merely very powerful automobile head-lamps, very well streamlined, so that the pilot can switch them on or off at will. They are used in a similar manner to Holt's landing-lights. (See chapter on Night Flying.)

Navigation Lights

These are composed of one light in the tail and one on each wing-tip. The wing-tip lights show a white light forward, a green light on the starboard side, and a red on the port side. The power for these electric lights is obtained from a small dynamo driven by a miniature propeller.

There is one small disadvantage in the use of Holt's landing-lights; that is, if the machine crashes on landing before the lights have finished burning, they may very easily set fire to the whole machine. In using the parachute flare the pilot should always carry a short stick, about three feet long, so that in case the flare jams in the tube, for many reasons, he can poke it through with the stick, for if he does not, there is a chance of the flare exploding inboard and setting fire to the whole machine.

The Sperry Automatic Pilot

The work of the night-bombing squadrons can be made much easier by equipping the bombing machines with the Sperry automatic pilot. How this remarkable instrument can help is told by Mr. Lawrence B. Sperry, as follows:

“The most evident advantages that the Automatic Pilot secures in bombarding operations are the following:

“The facilitating of night-flying.

“The accuracy and simplification of bomb-dropping.

“The elimination of one man.

“The reduction of physical effort on the part of the pilot.

“*Night-Flying.* The bewilderment that comes on a dark night, due to the pilot's imperfect sense of horizontality, is accentuated to a high degree when he is unable to secure those visual impressions that he is wont to use in the daytime. At night the pilot must depend for his sense of horizontality—experts tell us—on the reflex actions of certain semi-circular canals located in the interior of the ears and tactile impressions coming from the nerves, particularly those in the soles of the feet and other supporting portions of the body. It is not generally



Sketch-plan showing an outline topographic view of the Allies positions in relation to Heligoland, Kiel and Essen. The distance from the nearest Allied aeronautic centers on British soil to Kiel is only about 275 miles. There are now warplanes which are capable of carrying over one ton of explosives over a distance of seven hundred miles or more, and therefore capable of reaching Kiel at night. One thousand warplanes dropping a ton of bombs on the German fleet and U-boat bases could severely damage the German fleet.



A huge mountain of supplies for the Allied forces. Germany has similar mountains of supplies for her armies which can be destroyed by conducting major aerial operations against the German bases, thereby seriously impairing the efficiency of the work of the German forces.

known that these impressions are susceptible to serious error, due to centrifugal force or acceleration pressures, which are capable of reproducing and even multiplying gravitational sensations, when the machine approaches an unaccustomed inclination. The misinterpretation of these sensations has often resulted disastrously.

"Bomb-Dropping. In bomb-dropping it is quite needless for us to discuss the absolute necessity of having a gyroscopic horizontal reference plane of integrity and accuracy, or to enumerate the inaccuracies to which pendulums, mercury tubes, and other gravity devices are susceptible. Our experts have long ago exposed the total unreliability of all of these devices.

"The gyroscopic apparatus is capable of staying within one-quarter of one degree to the true horizontal. A sensitive aeroplane is held, through the intermediary of the servo motor and follow-up system, within three quarters of one degree of the position of this gyroscopic plane. This variation of three quarters of a degree might seem to the layman to be, in effect, a corresponding inaccuracy, but any one accustomed to reading a baragraph, the index of which is designed to tremble or vibrate constantly, will appreciate the ease and accuracy with which the pilot bomb-dropper can secure his objective in the mean of two extreme positions, especially when close to each other. In this way more ac-

curate results can be obtained than with non-oscillating conditions, because this motion makes all the parts of the follow-up mechanism extremely sensitive, as in the case of the baragraph. Furthermore, the slight motion assures the operator that the apparatus is functioning properly, while he need only consult his clinometer, located on the gyro unit, to check up accuracies.

"The proposition to connect the bomb sight directly to the gyroscopic element involves hampering its freedom by friction of the connection links, and by the inertia vibrations of the sight; in addition, pressure of the hand in making adjustments is likely to cause inaccuracies. It is always advisable to leave the gyro as free and unmolested from outside forces as possible.

"With the bomb sight rigidly fixed to the side of the machine or to the floor, the method of sighting is somewhat as follows:

"With the gyro manual-control the position of the aeroplane is adjusted until both clinometers read zero. The operator then secures by his rudder the motion of some objective in his field of vision, parallel to the longitudinal cross-wire. During this time the deviation angle is set by taking the usual stop-watch reading, or by other steps involving this very simple operation. The pilot bomb-dropper has now only to keep his ultimate objective moving along the longitudinal wire, before releasing the bomb when it reaches and crosses the lateral wire.

"The increased accuracy of bomb-dropping from an aeroplane equipped with the Automatic Pilot is due to:

"1. Being able to get the aeroplane more accurately lateral over the target.

"2. Being able to release the bomb at the proper angular distance from the target.

"3. Simplifying the operation of bomb-sighting, since the sight is held automatically and absolutely horizontal, thereby allowing the pilot bomb-dropper to focus his entire attention on adjusting the sight and steering the aeroplane.

"During the long night bombardments, the elimination of the extra passenger has the advantage of either increasing the radius of action or of enlarging the bomb-carrying capacity of the machine; while, of course, in the event of failure, one man is lost instead of two. The physical work of which the pilot is entirely relieved in long bombardment trips, especially

with the larger types of aeroplanes, would frequently be too much for the ordinary pilot."

Turn into the Wind to Avoid Drift

In bombing-raids drift is one of the most difficult factors to conquer by the use of instruments, because of the difficulty of calculating with accuracy, especially at night. There is a simple solution to this problem, however, which is always to turn into the wind when about to drop the bombs, and thus avoid the drift entirely.

Formation for Bombing Raids

Suppose one thousand large bombing machines were sent to bomb Kiel, Essen, or any other important German base. They would probably set out from five to ten aeronautic



An official air-photograph of Ostend after the British naval bombardment. It will be seen that the bombardment was directed against the Germans' submarine lair, the letters indicating the principal hits. Thus B represents the damaged entrance gates to basin; C, Q and R, destroyers struck; D, U and Z, pier and jetties hit. The other letters indicate damage to the submarine harbor and adjacent buildings. Ostend is an important German naval base.

bases, on carefully drawn plans. As there would be no advantage in having all the machines arrive at the same time, since there would be possibility of confusion and crowding, the plan would probably be to divide the thousand aeroplanes into from six to ten wings, each wing to consist of a given number of squadrons in charge of a squadron commander.

The raid would have to be carried out in the darkness between sundown and sunrise. In the autumn, winter, and spring, when the nights are longer, such raids can be conducted entirely under cover of darkness, and the raiders have little to fear from anti-aircraft guns and enemy aircraft. In the first large night-raid, made in August, 1917, by 232 Italian aeroplanes, only one machine was lost, the others being protected by darkness.

In a raid of a thousand aeroplanes, the best effect can be obtained by sending units of 200 to follow each other at intervals of half an hour. The second unit arrives after the first unit has done its work, and finds the theater of war ablaze with the fires started by the first unit. The lights assist in picking out the important points and objects to be bombed. The

succeeding units find their work correspondingly easy.

Rules for Formation Flying

The rules for formation in this case would be the same as prescribed by the General Staff of different countries. These are practically uniform, since each country adopts improvements as fast as they become known, which happens whenever a squadron or flight commander is brought down and printed or written instructions are found on his person.

The instructions of the British General Staff to squadron and flight commanders of bombing units—which are also applicable to fighting, reconnoitering, photographing, and other branches of the air service, are as follows:

A leader must be appointed, and a sub-leader, in case the leader has to leave the formation for any reason; *i.e.*, engine trouble.

The leader cannot efficiently control more than a certain number of machines. If, therefore, this number is exceeded, the mission must be carried out by two formations acting in concert, but each with its own leader.



A French Breguet tractor biplane used for bombing, photographing and artillery spotting.



Drawn by Frank Merritt

Courtesy of Motor Boating

Reducing the German fleet at Kiel with present day warplanes.

How 1000 Warplanes Could Raid Kiel

Suppose 1000 warplanes were to start from the Allies' lines in a major operation against German bases. They would start from different aerodromes, probably about one hundred from each aerodrome, the machines following each other at intervals of 30 seconds.

Squadrons of 25 machines would probably be formed, with a flight commander to each squadron, who would start first. The aviators of each squadron would follow as fast as possible, each aviator following the navigation lights of his squadron commander. A prearranged signal from the aerodrome would tell the squadron commander when the last machine of his squadron left the ground, and he would then, after a brief delay to give time for the machines to climb up, give the signal to fall in line, and the squadron would travel on in V formation. Every aviator, of course, would have studied the specially prepared chart and would be familiar with the route—as it looks to the aviator from the air.

Thus they would travel the 450 or so miles between the Allied bases and the German naval bases, or about the same to the important Ger-

man military bases. There being a crew of three men to each warplane, the aviators would not be as lonesome as they often are in bombing raids alone.

The distance would be covered in five to six hours. And then? Then, with the torpedoplanes attacking the German ships from the sides and the bombs attacking from above, the hardest blow yet struck at Germany, the most effective blow in the fight for humanity's rights, would be struck!

Just as the battles of Manila, Santiago, and Tshushima lasted only about an hour, so the battle of Kiel would be over in one hour, because the destruction of the German fleet from the air would make it possible for the Allies' minesweepers to clear away the German mines and open the way for the Allies' ships to deal with U-boats in their bases at close range. And Germany's naval power would be crippled thereby—and its total destruction would follow, through repeated raids on the less important U-boat bases.

So let us not lose a minute; let us concentrate the nation's efforts on turning out the thousands of torpedoplanes and warplanes needed.



Five different sizes of bombs dropped from aeroplanes. The weight of aeroplane bombs to-day varies from 16 to 500 pounds.

CHAPTER III

DROPPING BOMBS FROM AEROPLANES

By JEAN-ABEL LEFRANCE

Last February a French aviator, Captain Guynemer, succeeded in bringing down inside the French lines, one of a raiding squad of 20 German bombarding planes of the newest type, manufactured by the Gotha Wagonen Fabrik. A peculiarly interesting feature of the aeroplane was its Goerz sighting telescope or range-finder, designed to facilitate the taking of correct aim at objects to be bombarded. A careful study of this, with a discussion of the laws governing the dropping of bombs, appears in "La Nature"

(Paris), together with the accompanying diagrams.

Any projectile dropped from a height is subject, of course, to two constant forces, the resistance of the air and the acceleration due to gravity. Its trajectory is a vertical line from the point of discharge, A, to the striking point, B (Fig. 1). If the bomb be dropped from an airship in motion, it will have an initial speed equal to and in the same direction as that of the latter. This new force is compounded with

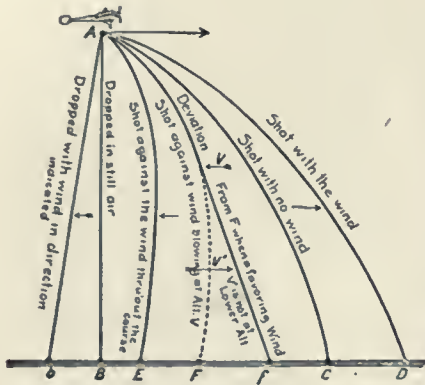

Fig. 1. Trajectory of a bomb falling from an aeroplane as affected by the direction of the wind.

the two former, and the result is the curved trajectory A C.

If this bomb, having a given initial velocity, is dropped into a layer of air in motion, that is, into the wind, it is acted on by the latter, and is said to undergo "drift." If the wind is at the back, the trajectory is lengthened, as in A D; if there is a head wind, the trajectory will be shortened, as in A E.

If the bomb be dropped from an avion which the strength of the wind causes to be stationary with respect to the ground, *i.e.*, when the velocity of the wind is exactly equal to that of the avion and in the opposite direction, the projectile will have no initial velocity and the



A Voisin bombing machine used by the Russians and the French.

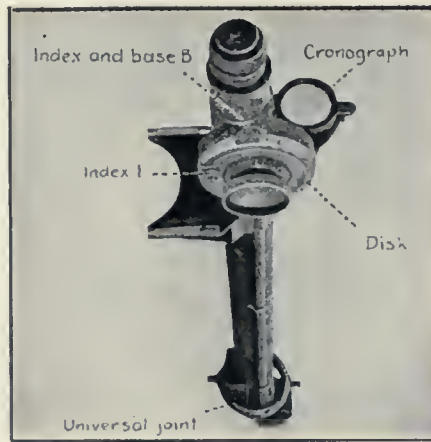

Fig. 2. The Goerz range-finder.

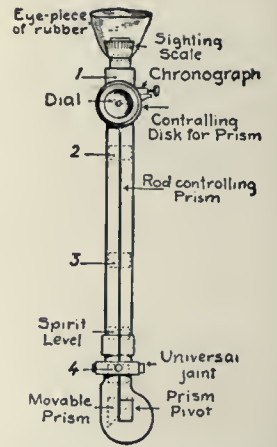

Fig. 3. Diagram showing construction of the Goerz range-finder.

curve of its trajectory will be a function solely of the drift produced by the wind, as in A b; it will therefore fall to the rear of the point of departure. This latter case, however, is exceedingly rare, since it presupposes a wind of 120 to 150 kilometers per hour; but this is a gale too high to permit the sending up of aviators.

These trajectories being given, the angle of aiming will be the angle formed by the vertical line A V at the point of departure A with the straight line joining this point A with the striking point O, *i.e.*, the angle VAO.

Since these trajectories are curves, the height of the avion above the object aimed at is an element which modifies the value of the trajectory. Since the wind causes drift, this drift will vary with the form of the projectile and with the velocity of the fall. Here we have two elements which are constant for each type of bomb.

To sum up, the trajectory of a bomb discharged from an avion is the resultant of the following forces:

- Weight } Elements constant for a given type of bomb
- Form }
- Drift }
- Speed of avion in } Considered as a constant for a given type of avion
- wind }

OTHER ELEMENTS

- Height of shot } Variable elements
- Initial speed of bomb, *i.e.*, of avion with respect to ground }
- Velocity of head wind }

Of these three principal variable elements which it is necessary to know for each case of bombardment, one of them, the velocity of the head wind, can be immediately deduced when the velocity of the avion with reference to the earth is known, since this velocity of the wind is the difference between the velocity of the avion with respect to the earth and its normal velocity in the wind, an element which is fixed for a given type of avion.

Take an avion having a normal speed of 150 km. per hour; if it is only going 100 km. per hour with reference to the earth, then it is flying against a head wind of 50 km. per hour. Hence it is only necessary to know the height of the avion and the initial speed of the bomb to determine a trajectory. This method of calculating trajectories seeks to base itself on science in order to obtain a mathematical precision in its results. Unfortunately it is based upon a probable knowledge of atmospheric conditions, which are essentially capricious. Particularly, the speed of the wind at the height of the avion is taken into account, *e.g.*, at 4000 meters, but it is supposed that this remains unmodified down to the ground, which is rarely the case in reality. It may also be that, starting from 3000 meters, the wind changes its direction so much that the best calculations, the best telescopes, and the best bombardiers, are unable to secure a correct aim, so that some authorities despair of ever being able to get results in aerial bombardment comparable to the efforts made.

Goerz Range-Finder.—This is certainly the best and most highly perfected effort of German science to find means of destroying railroads, factories, and populations outside the range of their big guns. It consists of a telescope about one meter long; mounted on a universal joint, it can be oriented in every direction and kept strictly vertical whatever be the position of the avion (Fig. 2). The accompanying diagram (Fig. 3) shows the ensemble of the optical system; the field obtained is 500/1000 and the enlargement is 1.5.

At the base of this telescope is a prism mounted on a pivot and controlled by a graduated disk. The telescope remaining vertical, the play of the prism permits the visual ray to

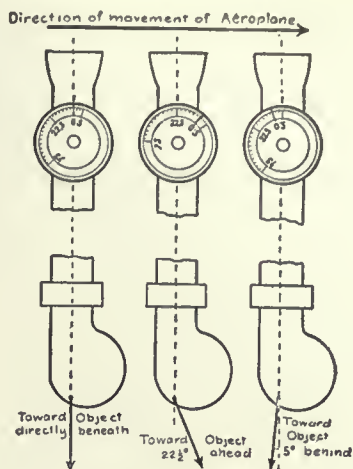

Figs. 4, 5, 6. Direction of aim in the finder.

be inclined a number of degrees corresponding to the graduations of the disk.

On this disk are two indexes, one corresponding to the vertical speed, or dead point of the range-finder, and the other to the vision of 22° 30'. Another index serves as a basis; it is fixed on the body of the range-finder. At 0° the marksman sees the ground along the vertical (Fig. 4); at 20° the inclination of the visual ray is 20° in front of the avion (Fig. 5); at 5° the inclination is 5° behind the avion (Fig. 6).

A small index is movable upon the disk, but this can be made solid with it by means of a little



Three different types of bombs dropped by Allied aviators at Salonica.

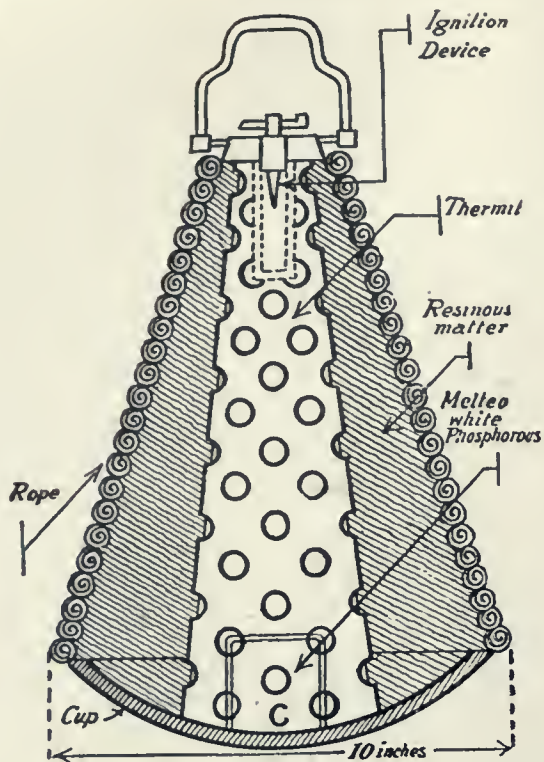

Section of Incendiary Bomb dropped from Zeppelins. The incendiary bomb illustrated herewith is being used by German airships for the purpose of setting afire enemy towns and military establishments; it is described in a poster published by the British Fire Prevention Committee as follows: "The usual fire-bomb dropped by a Zeppelin is of conical shape, the diameter at the base being about ten inches. It is wrapped round with inflammable cord, which gives it rather a nautical appearance, enhanced by a handle at the apex for lowering it over the gunwale of the airship—if airships have gunwales. The base is a flat cup, and from this to the handle runs a hollow metal funnel forming the center and business part of the bomb. This center funnel is filled with thermit. Thermit is the preparation which on ignition produces a heat so intense as to melt steel. The ignition of thermit creates a tremendous glare of light, and the heat melts the metal funnel. The molten metal spreads when the bomb strikes. It sets up at once a fierce fire if it strikes anything combustible, but at the beginning it is only a small fire, and if it is tackled at once with water it can be put out before it does any damage to speak of.

detent. This index once fixed before a graduation of the disk, after passing the dead point falls into a small notch, and thus informs the gunner that he sees the ground according to the inclination which he had marked with this index; this is disengaged by a slightly stronger pressure of the hand.

In the body of the telescope is a spirit-level. The edges of the air-bubble are refracted in such manner that they appear in the form of a black circle, which serves as a sighting center for the telescope. In the course of all his range-finding operations the gunner must keep this bubble in the center of the ocular, which will keep the

range-finder vertical no matter what the inclination of the avion.

The universal joint permits the finder to incline freely from right to left or from front to rear, but when it revolves around its vertical axis, *i.e.*, when the visual ray, instead of being directed in front of or behind the avion, is directed to the right or the left of the route followed, the finder acts upon a route corrector. This consists of an electric device. Resistances act upon a very sensitive galvanometer placed in front of the pilot and indicate to him how to correct his route in order to make it pass exactly above the object to be bombarded.

Method.—There are only a few of the elements constituting a trajectory which can differ in the course of each bombardment: the height of the avion above the object, the initial velocity of the bomb, the speed of the wind. The German method of the Goerz finder enables a calculation of these three elements to be made.

1. The height is obtained by subtracting from the altitude range shown on the altimeter of the avion the altitude of the object bombarded; *e.g.*, if the avion is flying at 4200 meters above sea-level, and if the factory to be bombarded is 200 meters, then the height to be reckoned with will be 4200—200—4000 meters.

This method, moreover, is subject merely to



An unexploded Zeppelin bomb in Great Britain which fell in a stack of hay on English soil.

very slight errors where high altitudes are in question. Example: At 90 km. an error of altitude of 500 meters for an avion at 4000 meters, corresponds to an error of only 25 meters at the ground level (Fig. 7).

2. *Initial Velocity of the Bomb.*—In reality this is the speed of the bomb with reference to the ground. This element is the most difficult to know, because it varies with the velocity of the wind, which is in a state of perpetual instability. If an avion possesses a speed of 150 km. and the wind is blowing at the rate of 50 km., then with a following wind the avion will travel at 200 km. per hour, while with a head wind it will go only 100. This difference of speed considerably modifies the trajectories, as can readily be seen by examining the curves in Fig. 7, in which the avion is going 120 and 60 km. per hour respectively. In place of being simply added or subtracted, this speed of the wind and speed of the avion may be compounded if the avion receives the wind, for example, three quarters to the rear (175 km. per hour) or three quarters head on (125 km. per hour).

In principle, to simplify the calculations, the avion should bombard with the wind head on, *i.e.*, with the speed as much reduced as possible. To determine this kilometric speed of the avion we calculate the time required by a fixed point on the ground O to traverse an angle fixed at 45° or $22^\circ 30'$.

It is easy to see by the figure that the time required by an avion to find the range of the same point successively, first with an angle of $22^\circ 50'$ and then vertically, is proportional to the speed of the avion with respect to the earth. A value in seconds is obtained.

A previous prepared table will indicate that if the avion being at an altitude of 4000 meters, a point on the ground takes 36 seconds to pass through an angle of $22^\circ 30'$, then the avion is going 100 km. per hour, with reference to the earth; if the point takes only 18 seconds to pass through the same angle, the



Another Sperry bomb sight which practically does all thinking necessary for accurate bomb-dropping.

avion is going 200 km. per hour. This value is the initial horizontal speed of the bomb.



A bomb dropped from a Zeppelin.

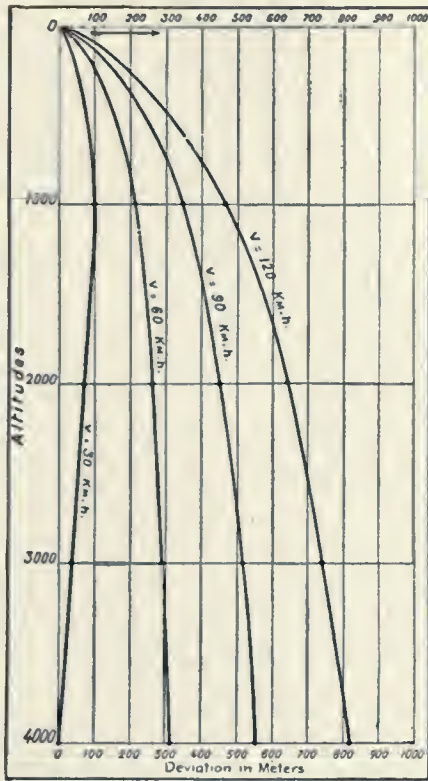

Fig. 7. The falling curves of bombs at different speeds.

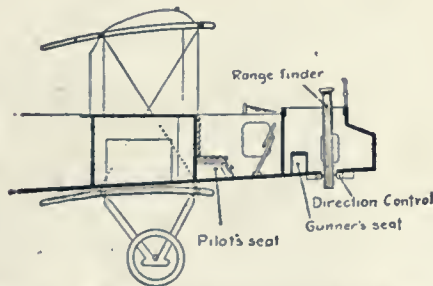

Fig. 8. Location of the finder upon an aeroplane.

3. Moreover, it is known that avions of the Gotha type have 150 km. per hour speed when the motors are revolving at their usual velocity; if the preceding range-finding shows the speed at the ground to be only 100 km. per hour, the obvious deduction is that the head wind has a value of 50 km.

Thus all the elements of the trajectory sought are known; it remains only to read on the chart which firing angle is suitable to cause the bomb to fall on the given object, in view of the given elements.

Several minutes before arriving over the object to be bombarded it is necessary to acquire a knowledge of two elements which will enable the gunner to read on the chart the proper firing angle. The altitude range on the ba-

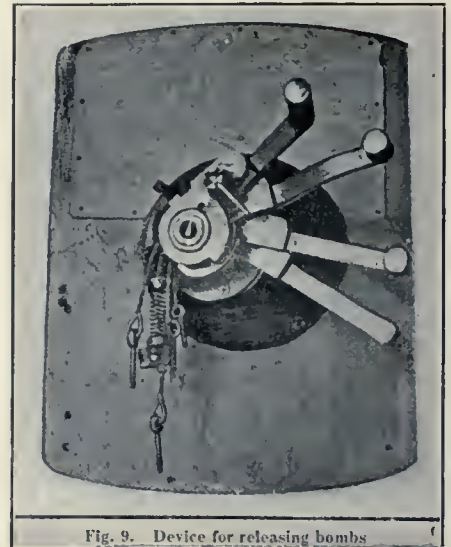

Fig. 9. Device for releasing bombs.

rometer less the altitude of the object gives the height of the fall of the projectile.

To obtain the second element, which will give a knowledge of all the values of speeds, we have recourse to the method of previous range-finding of the ground, explained previously.

The index of the graduated disk is fixed at $22^{\circ} 30'$. The range of any point whatever on the ground forward of the avion is found—a



Copyright by Underwood & Underwood.

Bombs in the fuselage of an aeroplane.



A 100 lb. bomb dropped by a Zeppelin.

falls into the notch at the dead point, *i.e.*, at the moment when the finder aims with an angle of 10° , the bombardier operates the bomb releaser and the bombs fall toward the object.

Throughout the whole bombardment the pilot must keep his craft strictly head on to the wind; the air-bubble must be kept rigorously in the center of the ocular, the play of the prism alone serving to seek the object.

This Goerz range-finder is of an elementary simplicity for any one who has manipulated it in a few brisk actions. Its movable prism enables the object to be found with ease, and its annular bubble permits it to be immediately centered in the vertical position. Marvelously constructed, it appears to show marked progress over all previously made range-finders.

It eliminates errors, except from new and practically incalculable elements, such as variations of forces and directions of the wind between the altitude at which the sighting is done and the ground, or when it becomes impossible to keep the avion head on toward the wind.

route perpendicular to the one followed, a river, a house, the edge of a wood. This point is caught in the circle formed by the air-bubble and followed while turning the disk until the index falls into the notch at the dead point; at this instant the seconds chronograph is released and the terrestrial point continues to be followed in the range-finder until the 0° of the disk is checked at the dead point. The chronograph, immediately stopped, gives a number of seconds which, when found upon the chart in the line of altitude, indicates the speed of the avion with respect to the ground and the sighting angle to make use of, for example, 10° .

The index is immediately set at the number of degrees of the sighting angle, *i.e.*, 10° . The observer is ready to operate. About 2 or 3 km. before flying over the object the latter is caught in the field of vision, then in the circle of the bubble. At this instant the route corrector operates and the galvanometer indicates to the pilot whether he is following a route which will make the avion pass directly above the object.

At the precise moment when the index fixed at the number of degrees of the sighting angle



American-made Barlow aircraft bombs. Photo courtesy New York Times & Western Newspaper Union

The aim being at times scientifically perfect, as the application of a method derived from calculations, does it follow that the bombs will fall directly upon the objects aimed at? Results loudly proclaim a negative. Hundreds of bombs discharged on railway stations, on famous ironworks, on important aviation terrains, have been without result, except for a few shell "funnels" in the ballasts, a few laborers killed, some holes in hangars. Range-finding is a delicate task to execute in an avion surrounded by bursting shells.

Memoranda:

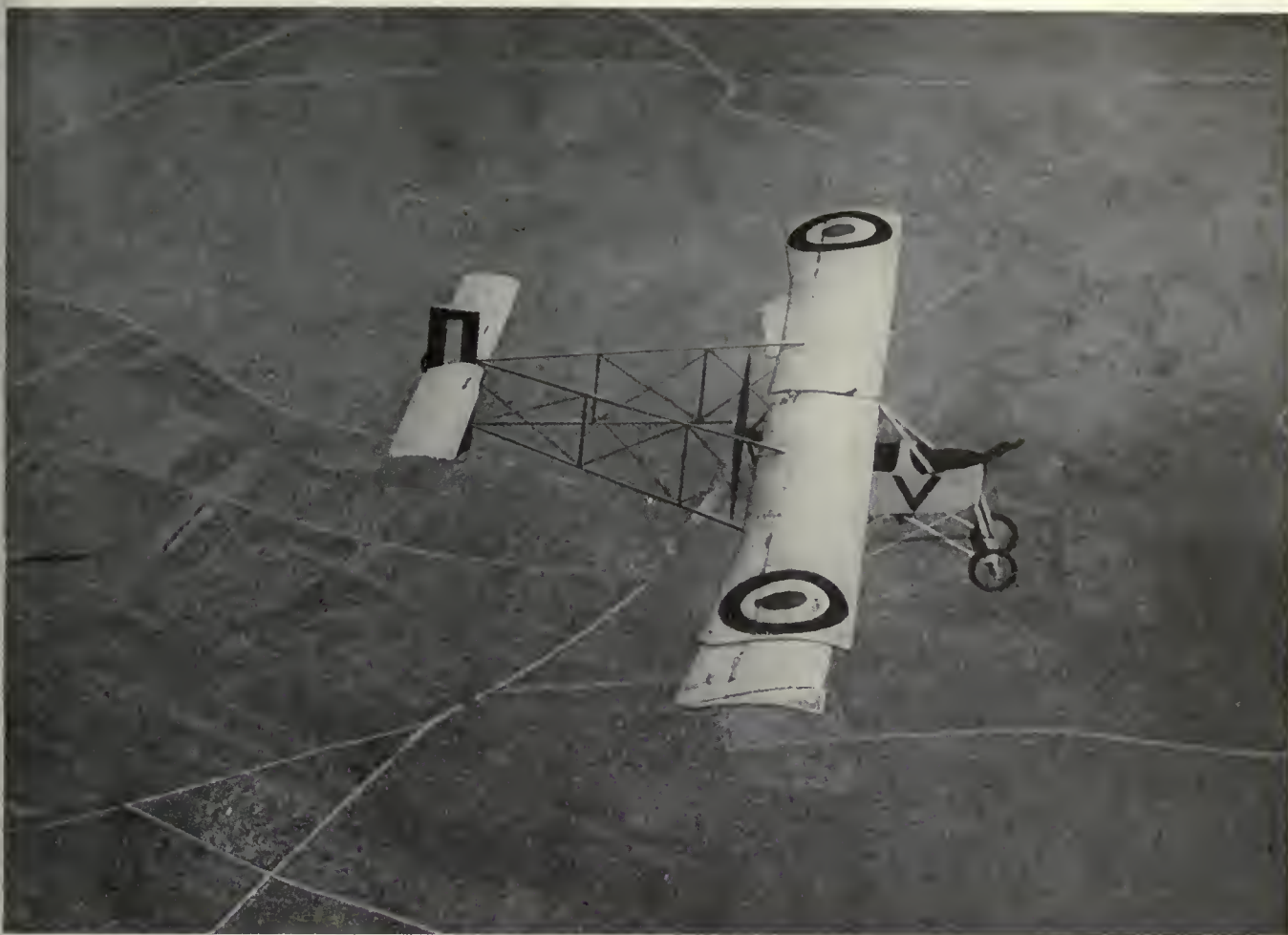

The master of the air. A Voisin armed bombardment machine equipped with aircraft gun of large caliber photographed in mid-air. This machine is equipped with a Canton-Unné motor.

CHAPTER IV

BATTLEPLANES AND AIRCRAFT GUNS—THE DOMINANT FACTORS IN MAINTAINING THE SUPREMACY OF THE AIR

Supremacy in the air, the all important factor which leads to victory on land and sea, depends greatly on battleplanes and aircraft guns.

About twenty per cent. of the service aeroplanes used by the warring nations at present are the very fast *avions de chasse* or pursuit machines used exclusively for fighting; seventy per cent. are the slower types used for regulating artillery fire, aerial photography, scouting, and in connection with infantry and cavalry operations; five per cent. are the slower, large bombing aeroplanes. All of these aeroplanes carry machine guns; some carry cannons.

Proportions of Different Types of Armed Aeroplanes in the Air Service

The proportions vary continually in accordance with developments, and the future will see an increase in the number of bombing machines, with possibly an increase of fighting machines. Raiding from now on is to be carried out more and more extensively, and in connection with the protection of bombing planes, as well as the protection of artillery "spotters" and photography planes, aerial fighting will increase.

Pursuit machines will always be needed to fight enemy aviators, but the practice of send-

ing pursuit machines to protect the artillery spotters and photography planes will grow less and less, because it is more economical to employ large machines capable of carrying two or more guns and to defend themselves.

Otherwise it is hard to protect a plane with less than four to six fighting machines. To protect themselves these planes must carry from three to four guns. Many a photography plane, equipped with only one gun, has been brought down by an enemy aviator who darted at it suddenly and riddled it with shots while the observer was taking photographs and did not see it approach.

Therefore a change is taking place toward larger machines to do this work, which are capable of carrying three to four guns.

The Five Fundamental Factors in Maintaining Supremacy in the Air

The five fundamental factors in maintaining supremacy in the air are:

- (1) Speed.
- (2) Position of the aeroplane.
- (3) Skill in piloting the aeroplane and in manipulating the guns.
- (4) Number of aeroplanes.
- (5) Destructiveness of the projectiles.

Speed is incontestably the most important factor. The value of *position* as a commanding factor was first demonstrated by the famous German aviators, Captains Boelke and Immelmann, who would climb high and take a position as near as possible to a cloud. There they would wait for an Allied aeroplane, then dive down towards it, firing the machine gun at the same time. If they missed their prey, they would not attempt to challenge the Allied aviators or to manœuvre to a commanding position and give battle. Failing in their first dive, they would land and go up again later to try it all over. It cost the Allies a great many aviators and aeroplanes before they found out the value of *position* as a fundamental factor in maintaining supremacy in the air.



A 37 millimetre Hotchkiss cannon mounted on a French "Voisin" battleplane.



The famous French aviator Védrières examining the two guns of a German battleplane, which are so mounted that they can be shot in a half circle and up and down—through the hole in the fuselage.

Skill is an important factor, and often makes it possible for an aviator whose machine makes five miles less than his adversary to fight on an equal basis.

Number makes up for lack of speed or position. Having two or three machines to the enemy's one, makes up for the handicap due to lack of speed.

Destructiveness of projectiles is a very important factor. The bullet of a machine gun must strike either the pilot, or the propeller, or the motor, or the gas tank, or the control wires, to put the machine *hors de combat*. The shell, on the other hand, will put the machine *hors de combat* if it strikes practically any part of the machine.

Types of Aeroplanes and Their Armament

The types of aeroplanes used by the warring countries, and their armament, have been

changing continually. At the date of writing, the following types are used:

Avions de Chasse or Combat Machines

(1) The "*Spad*," carrying one or two passengers. A number of these machines have, unfortunately, fallen in the hands of the Germans, so we may say that their horse-power ranges from 150 h.p. to 250 h.p. and are equipped with Lewis and Vickers machine guns.

They are used extensively by the French.

(2) The "*Nieuport*," one passenger, equipped with one 110-horse-power Le Rhone motor, capable of a speed of 150 kilometers per hour; equipped with two and three Vickers or Lewis machine gun synchronized to shoot through the propeller.

(3) The "*Avro*," carrying one or two passengers, equipped with one 100-horse-power Gnome motor, carrying one or two guns.



The A. E. G. 1917 single motored type of German biplane, equipped with a 175 h.p. Mercedes motor.

Avions Types "Corps d'arme"—Used for Spotting Artillery Fire, Aerial Photography, Etc.

(4) *The "Caudron" G-4*; pilot and observer; equipped with two 80-horse-power Le Rhone motors, Lewis and Vickers guns forward and rear.

(5) *The "Caudron" G-6*; two passengers; equipped with two 110-horse-power La Rhone motors, carrying one machine gun forward and one in the rear.

(6) *"Dorand" A-R*; two passenger; equipped with one 150-horse-power Hispano-Suiza motor or a 170-horse-power Renault,

carrying one Vickers gun forward, and two Lewis guns in the rear.

(7) *Farman*; pusher type, two passenger; equipped with one 170-horse-power Renault motor, carrying one or two Lewis guns forward.

(8) *Morane Parasol*; two passenger; one 110-horse-power La Rhone motor, mounting one Lewis gun in the rear.

(6) *Caudron R-4*; three passengers; equipped with two 150-horse-power Hispano-Suiza motors, with two Vickers guns mounted forward in turrets, and two Lewis guns in the rear.

(9) *Letort*; equipped with two 150-horse-power Hispano-Suiza motors; two Vickers guns mounted forward in turrets and two Lewis guns in the rear.

(10) *Moineau*; three passengers; one 220-horse-power Samson motor, connected to drive two propellers; equipped with two Vickers guns mounted forward in turrets, and two Lewis guns in the rear.

(11) *Sopwith Trip'ane*. This type of machine has, unfortunately, fallen in the hands of the enemy, therefore we may note its existence as a combat machine used by the British.

(12) *Sopwith* biplane; two passenger;



A "G-4" Caudron biplane, equipped with two 80 h.p. Le Rhone motors. The gun mounting is seen in front.



The officers of a squadron of Voisin bombing machines being decorated for their successful raids.

equipped with 130-horse-power Clerget motor, carrying eight bombs; Vickers machine gun forward, shooting through propeller, and one Lewis gun in the rear.

(13) *Voisin-Peugeot*; two passenger; equipped with a 220-horse-power Peugeot motor; carrying two Vickers or 37 millimeter guns forward.

(14) *Bréguet-Michelin*; two passenger; equipped with one 220-horse-power Peugeot motor; mounting two Vickers or 37 millimeter machine guns forward.

(15) *Farman*; pusher type, two passenger; equipped with one 170-horse-power Renault motor, mounting one Lewis gun forward.

(16) *The Caproni*; the various types mentioned in the chapter on "Warplanes for Bombing and Torpedo Launching," are with Fiat machine guns and cannons and Davis non-recoil guns. So are the Pomilio SIA, Savoya-Verduzio and Macchi machines.

At date of writing, the British, French, and Germans can be said to have more or less the

same types of aeroplanes, with the same amount of armament. As a matter of fact, the warring nations are never far from each other in either types or armament, because as fast as they capture each other's machines and find important improvements, they copy them.

Pursuit, or Combat Machines

Among the comparatively new machines of the British Royal Flying Corps, there is the *Sopwith* triplane, which has given such a good account of itself as a combat, or pursuit machine on the Western fronts. Other machines of this type are the *De Haviland* scout biplane, a "pusher" with a fixed gun in front, and the Vickers biplane, two passenger, equipped with Beardmore or Clerget motors.

The German combat machines include the *Ago*, the *Fokker*, the *Halberstadt*, the *Roland*, which are equipped with Mercedes, Oberunsel (rotary), Benz, and Argus motors of 165 to 175 horse-power. They are armed with Parabellum or Vickers and Lewis guns.

"Two Tails," twin fuselage simple motored German *Ago* biplane equipped with a 150 h.p. Benz motor and Parabellum and Vickers guns.





The German "Rumpler" biplane, two-seater, equipped with two guns.

The two smallest machines, the Halberstadt and the Albatros Bü, are single seaters, all the others being two-seaters. Where the gunner occupies the rear cockpit, it is found that in many cases the pilot is equipped with a synchronized gun, fired forward and sighted by steering the machine itself. The same applies to the single-seaters. Some of the single-seaters are equipped with two synchronized guns, fired directly in front. The top wing of the Albatros Bü is 28 feet, 4 inches, the bottom wing 26 feet, nine inches; gap, 5 feet, three inches; chord, five feet, nine inches; length over all, 24 feet. The measurements of the Halberstadt are: top wing, 28 feet, 6 inches; bottom wing, 26 feet; gap, four feet, 6 inches; chord, 5 feet; length, 24 feet.

The measurements of the Nieuport and the

Spad are: *Nieuport*; top plane, 24 feet 6 inches; bottom plane, 23 feet; chord, top plane, 3 feet 11 inches; bottom plane, 2 feet 4 inches; gap, 4 feet 2 inches to 3 feet 5 inches; length, 18 feet 6 inches. *Spad* type 5VII, one passenger; top plane, 25 feet 8 inches; chord, 4 feet 7 inches; gap, 4 feet 10 inches; length, 20 feet.

The speed of these machines varies with the horse-power, ranging from 95 miles to 125 miles per hour high speed, to from 56 miles to 80 miles slow speed. The climbing speed ranges from 4000 to 10,000 feet in ten minutes.

Owing to lack of demand, few machines of this type were built in the United States until recently. But efficient types existed. The Curtiss wireless scout of 1915-16 was followed by the Curtiss triplane, the characteristics of which cannot be made public.



The Italian Pomilio combat plane, said to be the fastest battleplane in existence. (Official Italian Photo.)



The German "Spad," the 175 h.p. Mercedes motored "Albatros" combat biplane. It carries two Maxim guns which are synchronized to shoot through the propeller.

The Triplane—A Scientific Solution of the Problem of Getting Speed and High Factor of Safety

The triplane solves the problem of getting high speed with the low landing speed and high factor of safety. The additional plane affords sufficient increase in carrying capacity to lift the additional weight of stronger construction, and also makes slower landing possible, without much additional head resistance.

The battleplane, while representing only one fifth of the types of machines used in the present war, is the key to command of the air, because the skies must be cleared of enemy aviators before the scouts, bombing, artillery, and infantry aeroplanes can work efficiently. Of course, if one side could outnumber the other side, the equivalent of the fighting power afforded by the fast battleplanes could be obtained by the advantage afforded by number, which makes up for having a few miles less in speed or less skilful aviators.

But neither side has been able to outdistance

the other appreciably in numbers; therefore command of the air is still decided by speed, the pilot's skill, and the pilot's ability to gain an advantageous position, like the famous Captain Boelke, who used "position" as a winning factor.

As a general rule, however, speed is the basic factor for achieving command of the air. Hence every effort is made to get speed, and the factor of safety in construction is only given second consideration, when it is considered at all.

Triplane Safe, Even if Wing Is Shot Away

The triplane is safe, even if a wing is shot away; the remaining wings will support it for the rest of the flight under any normal conditions. A biplane usually collapses soon after a wing has been shot away, and a monoplane collapses immediately.

Triplane construction removes the speed limitations imposed upon the small biplanes and monoplanes by their limited lifting power;



A squadron of Nieuport combat machines.

therefore speed can be increased to close to 150 miles, going beyond the margin of safety of the average biplane battleplane.

Battleplanes that Collapsed in the Air— Loss of Factor Safety Not Compensated

A recent despatch stated that German battleplanes have been collapsing in the air, at times without being hit, often when but slightly damaged. The despatch follows in part:

“With the British armies in France, via London—British pilots continue to bring in accounts of German aeroplanes breaking to pieces in the air soon after being attacked. That tendency has been notable for more than a fortnight. Once shot out of control, the German aeroplanes have lost their wings, tails, and other gear to such an extent that when they finally crash on the ground, very little wreckage can be seen.

“A British pilot recently flew at an enemy machine head-on, manœuvring at the last mo-

ment just in time to avoid a collision. One of the wings of the British aeroplane, however, scraped one of the German's wings, whereupon the latter began to fall. The British pilot dived after him and was startled to see the German's damaged wings fly completely off, while the tail dragged as if its back was broken.”

The causes are evident. In the struggle for additional speed, there has been sacrificed the factor of safety. The machines are merely shells of machines.

Triplane construction is a scientific solution of getting greater speed and high factor of safety, but there is, of course, nothing to prevent cutting down the factor of safety, so as to get a few miles more in speed.

Considering the fact that low factor of safety involves the loss of aviators and machines through accidents, as well as through machines collapsing when slight damages are inflicted by gun-fire or other causes, and that this loss involves a decrease of skilled aviators and number of machines, the writer contends that this loss is not compensated for by the advantages afforded by the slight gain in speed. As already pointed out, while speed is the most important factor in maintaining supremacy in the air, five miles or so less speed than that of the adversary can be compensated for by having skilful aviators, or a greater number of aviators and aeroplanes.



The German “Roland” two seater, so built that the pilot sees over the upper plane and has but a single strut, like the “wireless” Curtiss of 1916. It is equipped with a 150 h.p. Benz motor.

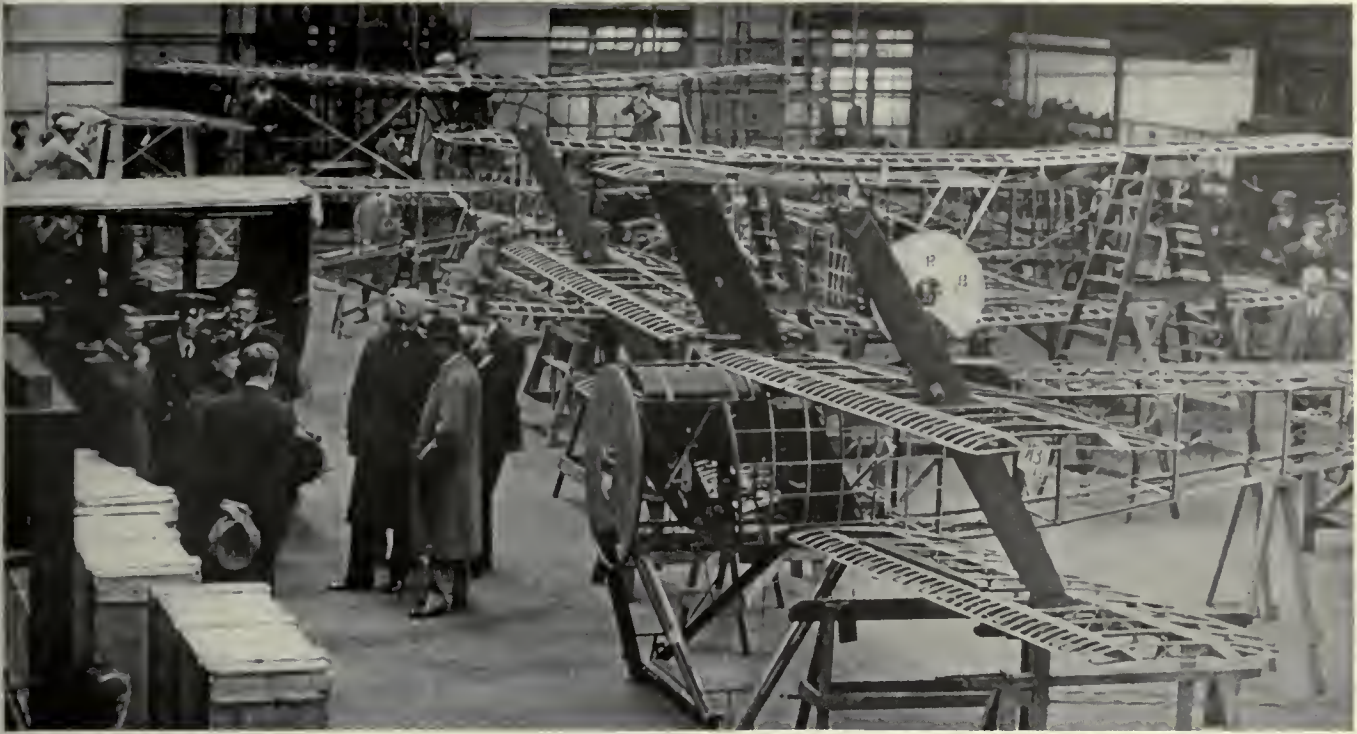

Triplanes being assembled at one of the Sopwith factories in England, being inspected by the King and Queen of England. These triplanes are equipped with 130 h.p. Clerget motors.

Large Aerial Destroyers

The larger army machines are four: The "Moineau," the "Voisin-Peugeot," the "Bréguet-Michelin" and the "Farman." These may be called "destroyers," no matter what they may be used for. The most popular British machine of this type is the "Handley-Page." This machine is equipped with two twelve-cylinder Rolls-Royce cylinders of 280 horse-power each; the top wing has a 98-foot span; the lower wing, 65 feet. It has mountings for three Lewis guns.

The Germans have several machines of this type. The twin "A. E. G." (manufactured by the Allgemeine Electricitats Gesellschaft) is a three-seated tractor biplane with two 180-horse-power Mercedes motors. Like all machines of this type, including the French, British, Italian, and Russian, it is equipped with two pairs of wheels. Its armament consists of Maxim guns forward and rear, and a bomb-dropping device in front of the passenger's seat.

The "A. G. O.," a twin-bodied pusher, usually equipped with a single Benz 175-horse-power motor; the latest are equipped with a

Benz 220-horse-power motor. It carries two guns mounted on turrets in front.

The twin-motored 520-horse-power "Gotha" is a three-passenger biplane usually equipped with two six-cylinder Mercedes motors of 260 horse-power. The wings are 76 feet in span. The length of the machine is 38 feet. It is usually armed with Maxim guns forward and rear, and it fires downward through a hole in the rear fuselage. It is equipped with three bomb-dropping devices and carries 144 bombs.

In the smaller German armed machines not already mentioned, are the following: The "Pfalz" monoplane, equipped with a 100-horse-power Oberrusael rotary motor. Its armament consists of two fixed guns, mounted on each side of the pilot and firing through the propeller.

The "Fokker" is also equipped with two Maxim guns firing through the propellers.

The "Albatross C-3"; the "Aviatik"; the "L. V. W."; and the "Rumpler" represent the average type of German biplanes. The size of the top wing is from 39 to 42 feet, 10 inches; the bottom wings from 35 to 38 feet; and the length from 26 feet 3 inches to 27 feet; they are all



A view of the French "Spad" equipped with the Hispano-Suiza 160 h.p. motor and Vickers gun in front and Lewis in the rear.

armed with Maxim guns shooting through the propellers; some carry Maxim or Parabellum guns mounted on turrets in the rear. They are equipped with from two to four bomb-dropping apparatuses.

In the United States there are, at date of writing, about a dozen types of twin-motored aeroplanes, all suitable for arming; but until the United States entered the war, no steps were taken to arm the machines with machine guns or equip them with bomb-dropping devices.

Aeroplane Guns and Cannon

The aeroplane guns and cannon employed to-day were developed in the year 1912-1914 and perfected, as far as their perfection goes, during the war. Considered from the standpoint of the guns of six years ago, the aeroplane guns of to-day are marvelously efficient.

The most extensively used aeroplane guns of small caliber are the Lewis and the Vickers by the Allies, and the Maxim and the Parabellum by the Germans. The Lewis machine-gun is an air-cooled, gas-operated, magazine-fed gun, weighing about 26 pounds with the jacket, or 18 pounds without the jacket. The gun is at present used almost entirely without

the jacket, without any loss of efficiency. Its extreme mobility makes it a most efficient gun for aeroplane work, being capable of operating in any position, firing straight up or straight down, or in any direction. The speed of getting into action and the ability to function automatically in any position are due to the use of detachable, drum-shaped, rotating magazines, each magazine holding 47 or 97 cartridges. When a magazine is latched on the magazine post, it temporarily becomes a part of the gun, requiring no further attention until empty, when it is snatched off and another snapped on, as quickly as an empty magazine is dropped out of an automatic pistol and a loaded one inserted. Further details of this gun will be given later, with the detailed description of its construction.

The Vickers is a water-cooled, recoil-operated, belt-fed machine-gun. Like the Lewis gun, it is capable of being fired at the rate of 300 to 500 shots per minute, maximum. Its advantage over the Lewis gun is that it is capable of being fired continuously up to 500 shots, whereas the Lewis requires changing of magazines after 97 shots. On the other hand, it has the disadvantage of being belt-fed, so it does not afford the mobility which the Lewis gun affords. The water-cooling in the Vickers, like

the air-cooling device in the Lewis, has been dispensed with for aerial work, as unnecessary.

Therefore, in most of the French and British planes one finds the Vickers gun fixedly mounted in front, and the pilot points the aeroplane at the enemy, instead of pointing the gun. The Lewis guns are mounted in the rear or in front, on mobile or fixed mountings. The German Maxim is practically the same as the Vickers gun used by the Allies. The Lewis shoots .33 ammunition, and the Vickers shoots .30 ammunition.

The Colt, a gas-operated, air-cooled, belt-fed, automatic gun, was used as an aeroplane gun in the beginning of the war, but there are few in use now. That is also true of the Hotchkiss and the Benet-Mecier, which is a modification of the Hotchkiss.

All belt-fed guns are subject to jamming, particularly when cotton is used instead of linen webbing, but in the air the one thing to be feared is jamming, due to the fact of the tremendous wind-pressure on the belt. The present method of mounting Vickers on aeroplanes has practically solved this problem.

The Fiat aircraft gun used by Italy is in the order of the Vickers, and shoots 400 shots per minute.

Large Aeroplane Guns

Details about the larger aeroplane guns have been kept secret, but there are many in use, there



French Nieuport "Avion de chasse" flying over a stretch of "no man's land" in France.

being squadrons of large aeroplanes equipped with them. A Hotchkiss one pounder, or one-inch gun, has been used in France and England. A Vickers pom-pom, or one inch, weighing 180 or 190 pounds, is reported as giving good results and the Fiat 37 millimeter has been a great success.

The Davis gun, the invention of Commander Davis of the United States Navy, made in one-inch and three-inch sizes, is a most remarkable weapon. The two pounder, six pounder, and 12 pounder are entirely non-recoil



The French "Corps d'Armée" type, "Letort" battleplane equipped with two 150 h.p. Hispano-Suiza motors and mounting two Lewis and two Vickers guns.

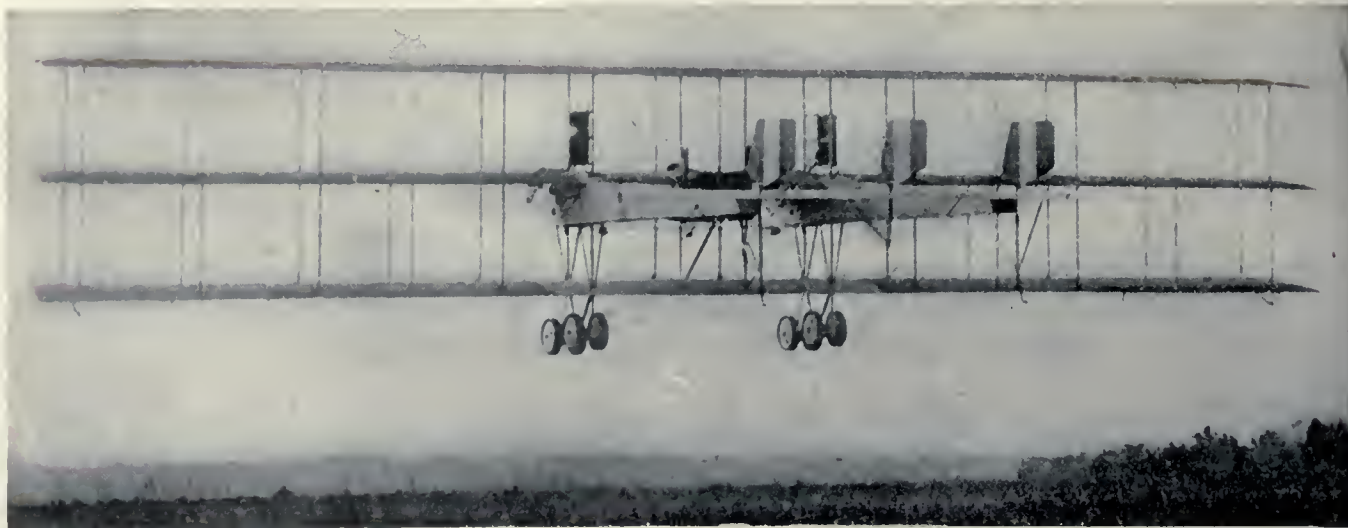

The three motored Italian Caproni biplane equipped with three Frascini motors.

guns. The two pounder is 10 feet long, weighs 75 pounds, shoots 1.575 projectile with a muzzle velocity of 1200 feet per second. The three-inch Davis weighs 130 pounds. It fires a projectile weighing between 12 and 13 pounds at a guaranteed muzzle velocity of 1000 feet per second, but it has shown a velocity of 1200 feet in tests.

Another American aeroplane gun is the Driggs one-pounder, now being manufactured. It fires one pound shells at the rate of fifty per minute, weighs one hundred and sixty pounds, including twenty rounds of ammunition, and the recoil pull amounts to six hundred pounds.

The Driggs Aeroplane Machine Gun, another new American gun, is similar to the Lewis gun in that it has a self-contained magazine, which holds one hundred cartridges, and the gun is operated by recoil, instead of by gas.

The larger guns, while not so mobile as the smaller, have greater destructive power and can reach further than the smaller guns. When they hit a plane, almost any part of it, they are almost certain of wrecking it, whereas the bullets of smaller guns are only effective when they hit the pilot or the vulnerable parts of the aeroplane.

Problems of Armoring—Vulnerable Parts of the Aeroplane

So far no progress has been made in the armoring of aeroplanes. To have an effective armor to protect the pilot and the vulnerable parts

would involve prohibitive weight, which would cut down the efficiency of the aeroplane beyond the safety point. The vulnerable parts of the aeroplane are: (1) the pilot; (2) the gasoline tank; (3) the propeller; (4) the motor; (5) the control wires. Of course, the pilot could be encased in a steel cabin, but that would limit his mobility, and the enemy aviator could fly close and hit the other vulnerable parts of the aeroplane without interference. The gas-tank and the motor can be armored to some extent without great additional weight, but when the matter is considered, it always appears that the



One of the Fokkers brought down by a French aviator. This shows the armored body and the Maxim gun mounted on top. General Gouraud, the late French Commander-in-Chief at the Dardanelles, is standing by the propeller.



The French Bréguet-Michelin bombing biplane equipped with a 220 Peugeot motor and two guns

weight involved could be invested to better advantage in adding a gun, thereby increasing the armament of the aeroplane by one unit.

The propeller and the wires cannot, of course, be armored. Air fighters always aim to hit the pilot of a machine. The gasoline tank, the motor, the propeller, and other parts of the aeroplane get hit as a result of the effort of the gunner to hit the pilot. Next to the pilot, the propeller, the gas tank, and the motor are the vulnerable parts of an aeroplane which get hit oftener. Only occasionally are aeroplanes brought down through the wrecking of the controls or other parts of the aeroplanes. Many aeroplanes come down at the end of a few hours' flight with several hundred holes in their planes, made by bullets from hostile aeroplanes and bits of shrapnel from the anti-aircraft guns.

Bullets vs. High Explosive Shells

A bullet striking the strut or the rib of an aeroplane merely leaves a hole, but very rarely

does more damage than that. A shell striking the same part will wreck the plane. Hence the shell has its advantages. The mobility of a larger gun would, of course, be less than the mobility of the smaller gun, but that is compensated by the destructiveness of the shot.

However, the necessity of having rapid fire in aerial fighting precludes the possibility of the larger gun replacing the smaller gun. One supplements the other. Another thing; it would not be possible to mount the larger gun so as to fire through the propeller with the synchronizing device. A shell hitting the propeller would wreck it, and possibly result in tearing the motor loose, breaking the gasoline pipes, and setting the machine on fire. With the smaller gun, a bullet "hanging fire" and striking the propeller seldom does more than make a hole in or splinter the propeller. However, hardly more than one bullet in 5000 hits the propeller. In firing with the synchronizing device, it releases a shot at every

four turns of the propeller, permitting the firing of about 300 shots per minute.

Explosive shells are used with Lewis, Vickers, Fiat, Parabellum and Maxim guns.

Fast vs. Slow Muzzle Velocity

Fast muzzle velocity has certain advantages, but has the disadvantage of involving greater weight, due to the necessity of having a stronger gun to withstand the additional discharge, and stronger mounting to withstand the greater recoil.

The same result can be obtained with slow muzzle velocity by aiming ahead of the target. In the beginning of the war, there being no precedent in aerial gunnery, considerable confusion resulted and there was accepted an extremely high muzzle velocity. Then it was decided that a maximum muzzle velocity of 800 feet per second was sufficient, giving the desired results, but eliminating considerable weight.

As a general rule, outside of aeronautics a gun weighs one hundred times the weight of the projectile. This weight is necessary to give it the velocity needed to carry the projectile vertically or horizontally over considerable distances. Shooting down from a height only requires a portion of that muzzle velocity, the projectile acquiring velocity in its downward trajectory.



A Lewis gun mounted on a French avion de combat.

Recoil; a Solved Problem

Up to the time of the war, it was feared that the recoil of a gun would affect the stability of the aeroplane. Even the recoil of small machine-guns was feared. It is now a solved problem for large machines. It has been found



The 1917 type Nieuport avion de chasse, equipped with two Lewis guns shooting over the planes, and a Vickers gun to shoot through the propeller. In the rear can be seen a "Spad" and several Nieuports.

This photograph shows the mounting of the two Lewis guns on top of the plane and one Vickers gun in front of the pilot seat of the single-seater Nieuport biplane. French official photo, passed by French censor. (Courtesy of "Flying.")

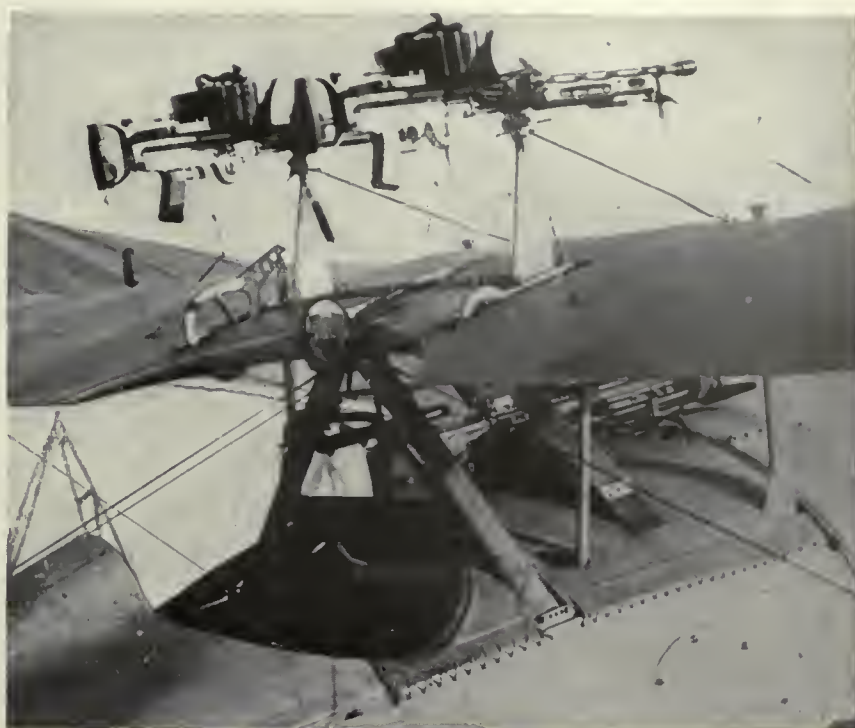

that aircraft absorb the recoil of any gun of a size suitable for firing from an aeroplane; that is, the aeroplane acts as its own recoil cylinder. This was first discovered in the early part of 1914 when a small naval cannon was mounted on the first Voisin gun-plane. That fear proved to be helpful, as it resulted in developing light, efficient machine-guns and cannon.

Tactics in Air Duels

For the sake of avoiding confusion, it is well to separate air duels into four classes, as follows:

(1) Air Duels in Which Participants are Both Air Fighters Whose Only Function is to Keep the Sky Clear of Enemy Machines

The aviator having this mission to perform usually flies out with a speedy machine equipped with from one to three aeroplane guns. He flies as high as he can and remains high until he sees an enemy machine. Then he dives down toward it and tries to bring it down by opening fire on it as he gets to firing distance, keeping up the stream of fire until he sees the enemy machine fall. If he missed hitting a vital part, he must either land, if he is

near his own lines, or manœuvre to a point of vantage to shoot at the enemy again, or try to rise vertically as quickly as possible, and manœuvre for a high position again, before the enemy gets to the point of vantage to open fire on him.

The first method, that of flying to a height and then diving down upon the enemy machine, opening a stream of fire on him, and landing in case of failure, was originated and adopted by Immelman and Boelke, the famous German aviators, who brought down a large number of Allied aviators before their tactics were known. But the success of that method is based on fighting enemy machines that are operating over one's territory and that in itself is basically faulty, as control of the air means striking the enemy aviators over the enemy's territory, never permitting the enemy aviators to come as far as one's own lines.

A very sound principle of tactics in air duels is to fly to a height, and then dive down on the enemy aviator, pouring a rain of bullets on him. This is, of course, the manœuvre that every aviator would like to perform. Being above the enemy is an advantage. Unless the enemy is hit and fluttering away, and needs only a few more shots to be put *hors de combat*, the practice is to make a sharp turn

and quickly climb to a height, and regain a point of vantage before the enemy can do so. Having reached a height, the pilot is again at the point of vantage from which he can shoot down on the enemy.

In aerial combats, as in naval combats, one's movements are often changed by the enemy's movements. The strongest and ablest drives the other into "tight corners" at sea. But in the air one can fly over, under, and around the enemy, and as both combatants are flying at tremendous speed, which reaches 150 miles per hour in dives, the combatants often fly about for many minutes before they get to a point of vantage from which they can shoot at the pilot, gunner, or vulnerable parts of the machine.

(2) Air Duels Between Combat Machines and Armed Photographing, Spotting, or Bombarding Machines

A duel between a combat machine and an armed photographing, spotting, or bombing machine is quite different from the duel between combat machines. The combat machine will dive on the armed larger machine, which will receive it with upward fire from one or more guns. If the combat machine succeeds in hitting one of the gunners, it only silences one of the guns, but still has to deal with the other gunners and guns. If the aviator does not succeed in hitting one of the gunners, then there is a regular battery of guns to shoot at him, and he will need



A 37 millimeter gun mounted on a Voisin-Peugeot gun plane.

all the skill that he can command to so manœuver as to avoid their fire. But while he may manœuver swiftly, the enemy machine does not manœuver so swiftly; it is not necessary, for it depends on driving away the small combat machine by sheer gun-fire and skill in gun manipulation. In the first year of the war, when few machines were armed with aircraft guns and rifles and pistols were used for aerial com-



A Davis non-recoil gun mounted on a British battleplane. The three inch gun of this type shoots a 15 pounder.

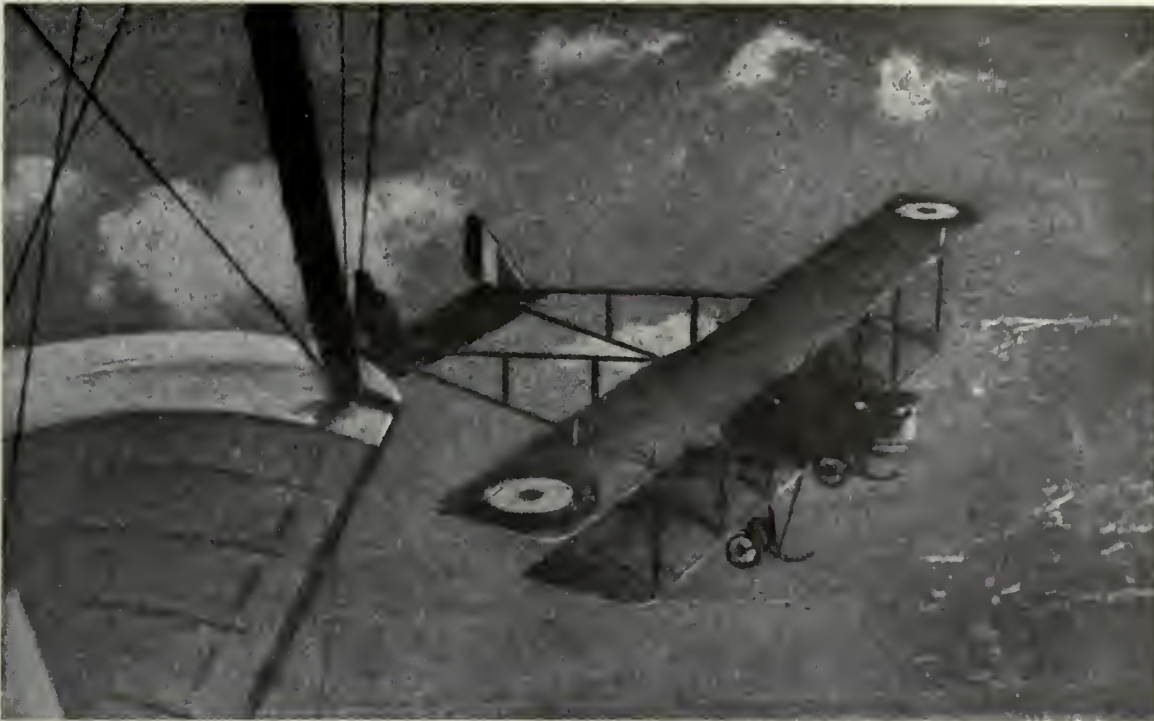

A Henry Farman biplane "Corps d'Armee" type, photographed as it was passing another French battleplane, 6,000 feet up.

bats, small, fast German machines attacked the large, slow, Russian Sykorsky machines and the Russian gunners were able to bring down the Germans with their rifle-fire from the platform of the Sykorsky machines.

(3) Air Duels Between Large Armed Aeroplanes

In air duels between large armed aeroplanes the tactics are different. These types of machines, being usually busy with taking photographs, spotting, or bomb-dropping, seldom go to great heights; and they are not so well adapted to diving and swift manœuvring as the combat machines. But that is where the nature of the gun and the marksmanship are the main factor in deciding the victory. As most of these large machines are either twin-motored or are of the pusher type, with the motor in the rear, they mount aeroplane guns of large caliber in front, and can shoot at the enemy from front and sides. The twin-motored aeroplanes also permit mounting guns in the rear, so that they can fight from almost any angle of attack. The employment of aerial guns of large caliber, and the employment of shells instead of bullets, brings a new factor of dominant importance in aerial combat. Whereas a bullet must hit one

of the vulnerable parts of the aeroplane to do serious damage, a shell will wreck the aeroplane practically every time it makes a hit.

Formation in Air Fighting

Formation in air fighting is part of the latest developments in the aerial part of the war. Fighting in formation began in the early part of 1916, and by the spring of 1917, in the intensive air fighting that preceded the Allies' drives, aerial combats had taken place in which as many as forty aeroplanes participated on each side.

Since then the official reports contain many incidents such as the following, which was dated June 6, 1917:

"Five hostile formations, all of which consisted of over thirty machines, were attacked and dispersed with heavy casualties. In the course of the fighting, nine German aeroplanes were brought down and at least nine others were driven down, out of control. Six of our aeroplanes are missing."

There are many instances of individual aviators who fought from 4 to 10 enemy aeroplanes and came out victorious, although not, of course, bringing down the 10 machines.

Lamp Signals for Use of Leaders of Formations

The code letters are painted on the machine where visible to the observer and within reach of the pilot's hand. When the leader wishes to give an order, he places his finger on the letter required, which the observer then sends to the machines concerned with the lamp. The order can be acknowledged by the lamp or by a "waggle" of the machine if lamps are not carried. Single-seaters working with two-seaters can take such messages.

The principles of formation defined by the British General Staff (see chapter on "Warplanes for Bombing and Torpedo-Launching") are applicable to fighting patrols, as well as to bombing, reconnaissance, and other patrols. The British General Staff also points out that in the face of opposition of any strength offensive patrols usually have to fly in formation, in order to obtain the advantage of mutual support, but the formation adopted may be governed solely by the requirements of offensive fighting. Single-seater scout machines, or even



A Vickers gun mounted on the "Spad" of a member of the Lafayette Flying Corps, and the belt with which it is fed.

two-seaters, if superior in speed and climbing ability to the great majority of the enemy's machines, may be able to patrol very success-



One of France's Short Distance Bombing Machines.

A squadron of German speed bi-planes of the Albatros type, painted in variegated colors.



fully alone or in pairs, taking advantage of their power of manœuvering and acting largely by surprise attacks; but in the case of machines which do not enjoy any marked superiority, formation-flying is essential. Fighting in the air, however, even when many machines are involved on each side, tends to resolve itself into

a number of more or less independent combats, and accordingly it has been found advisable to organize a purely fighting formation.

As far as possible, the groups should be permanent organizations, in order that the pilots may acquire that mutual confidence and knowledge of each other's tactics and methods, which is essential for successful fighting. It must be impressed on pilots that the group is the fighting unit, and not the individual.

Normally, a formation should consist of not more than three groups, and if greater strength is required separate formations should be employed, acting independently, but in such a way as to be mutually supporting.

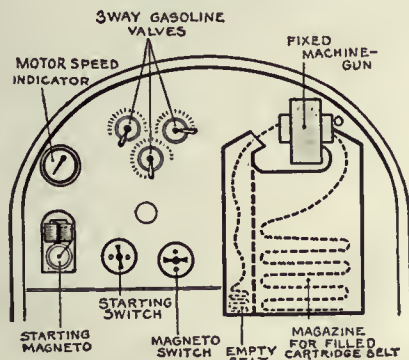
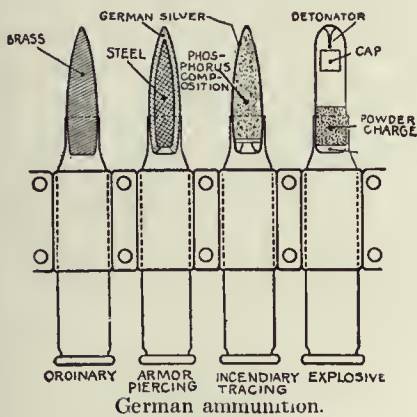

Position of the fixed machine gun in the fuselage (as seen by the pilot)

Courtesy of Aerial Age Weekly



British aviators figuring out a raid

The DeHaviland Scout Bi-plane, one of the more recent British pusher-type scouts.



A fighting formation should consist of machines of one type, but single- and two-seater machines can be combined for similar performance. A suitable flying formation with groups of three machines advances in column groups, with flank machines echeloned slightly back, the whole formation being in vertical echelon. The rear group is the highest, and in the case of a mixed formation consists of two-seaters, with machines of equal performance.

Fast single-seaters, if combined with two-seaters, should fly above them, circling so as to obtain a good view all around.

In the case of groups of two machines a similar flying formation is in line of groups, the two machines of each group flying one behind the other, the rear machine at a higher altitude. The flank groups should not be echeloned back, as in this position they will be unable to use the center group.



The British Vickers pusher biplane equipped with 100 h.p. Gnome motor. It mounts a gun forward.

Offensive Fighting Tactics

Realizing the fact that fighting tactics vary with the type of machine, and with the powers and favorite methods of individual pilots, the military authorities of the warring countries have not issued set rules.

Rules of Manoeuver

Individual skill in manoeuvring favors surprise. A pilot who is thoroughly at home in the air can place his machine by a steep dive, a sharp turn, or the like, in an unexpected position on the enemy's "blind" side, or under his tail. Individual and collective power of manoeuvring is essential if flying in formation is to be successful, or even possible. It can only be obtained by constant practice.

The following points must always be borne in mind:

(1) Pilots and observers must know the fuel capacity of their machine, and its speed at all heights.

(2) The direction and strength of the wind must be studied before leaving the ground and during the flight. This study is most important, since wind limits the range of action, and machines, when fighting, are bound to drift down wind.

(3) To guard against surprise, direction must be varied frequently, unless making for a definite point, and a good lookout must be always kept in every direction.

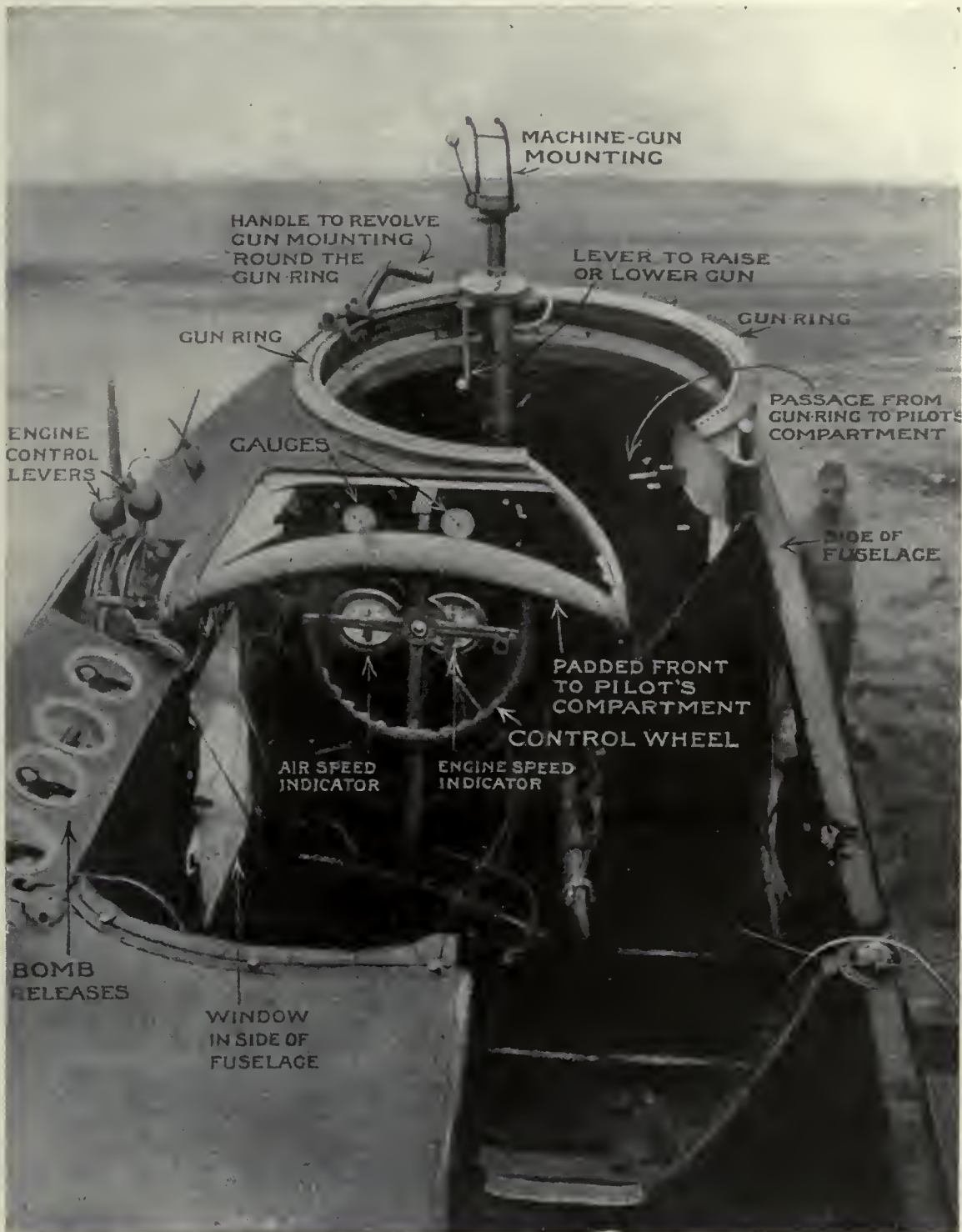

The fuselage of one of the Gotha biplanes which bombed London. Illustration by courtesy of Illustrated London News.

(4) Every advantage must be taken of the natural conditions, such as clouds, sun, and haze, in order to achieve surprise.

(5) The types of hostile aeroplanes must be carefully studied, so that the performance and tactics of each, its blind side, and the best way to attack it, can be worked out. Some machines have a machine-gun mounted to fire downward

and backward through the bottom of the fuselage.

(6) Height means speed; since it is easier to overhaul a hostile machine on a dive. If a hostile machine seeks safety by diving, it is bound to flatten out eventually and may, therefore, be overtaken by a machine from above, if the latter dives in front of it. The hostile

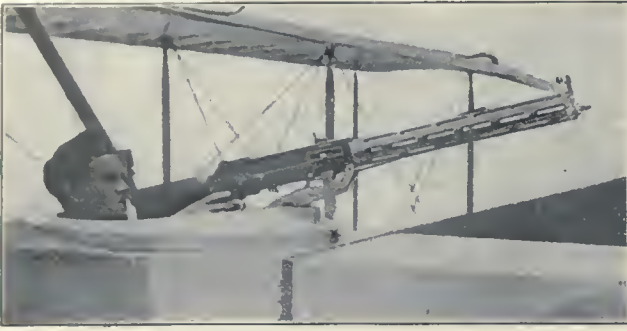

One of the German Parabellum aeroplane guns.



Three quarter view of the Sopwith biplane.

machine must be watched all the time, in case it turns.

(7) The engine must be always kept well in hand in a dive. If it is allowed to choke, the opportunity will be lost.

Thorough Knowledge of Weapons is Required

Machine-guns in the air, as on the ground, are very powerful weapons of offense, owing to the volume of fire they are capable of pro-



An aerodrome just back of a line of trenches in France photographed from an aeroplane. A twin-motored Caudron and some Sopwiths are shown on the ground. The motor transports are in the court-like place. (French official photo.)

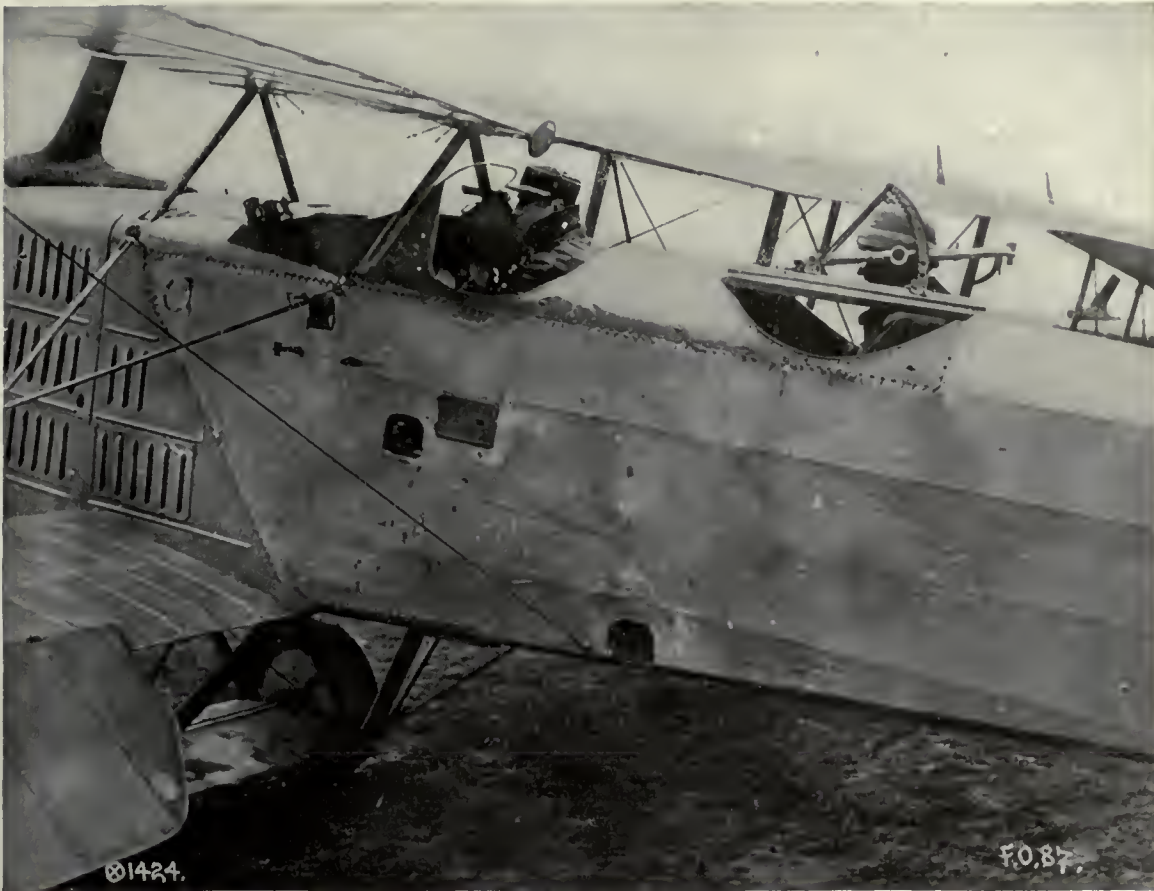

A French type of biplane used for aerial photography and to direct artillery fire, showing the gun mounting at the rear seat. (Photo Committee on Public Information.)

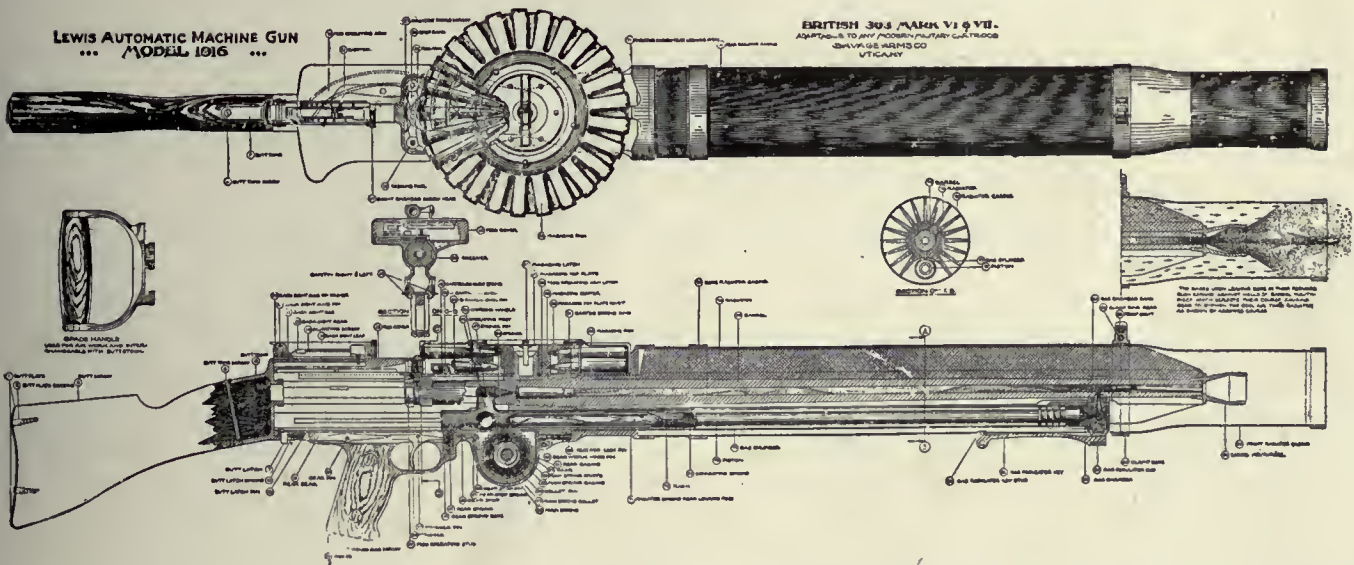

Section diagrams of the Lewis Automatic Machine Gun. The gun is an air-cooled gas-operated, magazine-fed arm, weighing 26 pounds. Its speed and ability to function automatically in any position are due to the use of detachable drum-shaped rotating magazines holding from 47 to 97 cartridges. It may be used with tripods or mountings of any design. The Lewis gun has shown adversivity and sureness of action which makes it equally effective on rigid bases or the undulating, fragil supports in the air.

ducing. Their effective use in the air demands even more skill and practice than on the ground. It is dependent on:

(1) Absolute familiarity with the mechanism of the gun, so that the jamming can be rectified in the air.

(2) A high degree of skill in manipulation and accuracy in aim, both on the ground and in flight.

(3) Constant study of the conditions affecting their use in an aeroplane, and continual practice under these conditions.

Memoranda:

CHAPTER V

THE FUNDAMENTAL PRINCIPLES OF AERIAL COMBAT

BY OSCAR RIBEL

Chief Instructor in One of the French Military Flying Schools

Translation by Augustus Post

The fifth arm has taken a very important part in the European war. The warmest advocates of military aviation in times of peace never dreamed of the vital importance of the aeroplane to-day.

In 1907 the most remarkable aerial flights were no farther than 1 kilometer, or $\frac{5}{8}$ ths of a mile, at a height of 30 meters, about 100 feet. The marvelous accomplishments in aviation during the last ten years are astounding. The most optimistic prophecies did not anticipate one half the actual reality. Who dared to believe, when Farman timidly tried his wings at Issy-les-Moulineaux, that nine years later escadrilles of thirty or forty aerial warriors would sail off into space to engage in heroic aerial combat against each other.

Aerial fighting has given an opportunity to develop in both the French and English rare qualities of courage, coolness, and hardihood. The Germans, on the other hand, are less well trained and equipped than their adversaries but, as is frequently recorded, exhibit undeniable bravery. The system used in aerial fighting differs in the German and Allied forces. In France we have distinct types of aeroplanes for different purposes, that is to say, for reconnoitering, "spotting" or directing artillery fire, and for carrying bombs. All these aeroplanes are protected by an escort of machines especially adapted for speed and fighting, and they are well armed. The Germans use their machines more indiscriminately for these various military operations. They do not have so many types of machines, and thus those they have are capable of being used for different

purposes with equal efficiency. An exception to this statement are the Fokkers and the Walvets, which are flown by their most expert aviators and are used exclusively for fighting the enemy.

From a technical point of view French aviation is about the same as German, but our pilots are superior scientifically to the Germans, and the number of our "aces" is constantly increasing. Practically all of them fly the Nieuport or Spad, and their victories up to date can be numbered by the hundred. Naturally we cannot describe the methods employed by each one

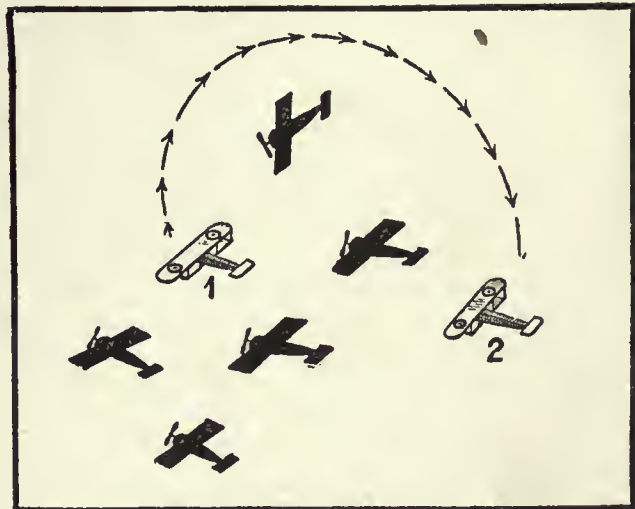

Fig. 1—The "Loop" as an aerial military maneuver. Attacked by four or five German machines, a French biplane turned completely over and returned by means of "looping the loop" to attack the squadron which was attacking him in the rear.

of these "aces" in fighting the enemy, because almost every one depends upon the marvelous individual skill with which they perform their acrobatic feats. One example among thou-

sands may be quoted. It is well known among escadrilles at the front and will give an idea of how every pilot must cut the "Gordian Knot." In the course of a reconnoitering flight in the East, sub-Lieut. Navarre found himself surrounded by five or six German machines. Three or four were above him and the others

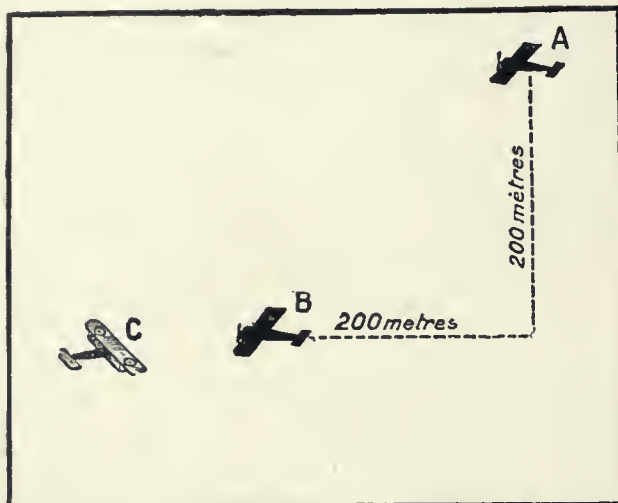

Fig. 2—The favorite attack of the Walvets. Walvets patrol two by two. A 200 meters above and 200 meters behind B. If a machine C is encountered B engages in combat with it while A remains to survey the zone of battle to prevent surprise on the part of another machine which might come up to render assistance.

were below or at the sides, which prevented him from going to the right or to the left, either in rising or descending. It seemed impossible for him to escape. Without losing for an instant his remarkable coolness, our valiant "ace" surprised his adversaries by making a complete loop over the entire group of assailants, and following up the nearest machines, discharged an entire belt of cartridges from his machine gun and brought down two machines one after the other. The other pilots retreated as fast as possible to their lines, pursued by the intrepid Navarre.

The German "aces" are much less numerous than our own, the best among them being Captain Boelke, who died the 28th of October, 1916, after having brought down his fortieth adversary.

We count as victories for our pilots only the enemy machines which fall inside our lines, or fall in flames in unoccupied territory, but the Germans do not hesitate to count every machine

which is brought down for one cause or another, and is thus obliged to abandon the fight. If we adopted the same method of counting, it is certain that Guynemer, among others, has brought down more than sixty enemy machines.

French aviators often fight twenty or thirty kilometers behind the German front. A German reconnoitering party must be checked in its operations and brought down if possible. During the course of our offensive on the Somme and at Verdun, our machines established a veritable barrier across our front, through which no German aviator was able to penetrate; and this lasted for several days.

Speed and climbing ability are essential for a fighting machine, as the aviator has to outfly his adversary and strike him in a vital spot at an opportune moment. The Fokkers, the Walvets, and the L.V.G. are the principle types used for reconnoitering over the front, and have a speed of 150 kilometers per hour (about 100 miles). They climb very rapidly, and the altitude at which aerial combat is generally fought is about 4000 meters (14,000 feet).

Generally speaking, the German fighting pilots, especially those who fly the Walvets, employ the following tactics when they come over our lines and engage our aviators. They always go in groups composed of units of two machines each. If an enemy machine is engaged by one of these units, the first of the German aviators begins the battle and the second man remains about two hundred meters above, his mission being to overlook the zone of combat without interfering directly with the fighting. If a second adversary comes to the rescue, however, it is his turn to attack and drive away the rescuer, while if his partner is vanquished, he returns to his lines as quickly as possible. Often the manœuvres are more involved, and the aviators fly in large squadrons for mutual protection. If an isolated enemy is encountered, he is quickly surrounded and must seek safety in the speed of his flight.

The speed of the fighting machines is great, and there is danger therefore of breaking the wings. A machine which flies at 180 kilometers an hour (about 110 miles), rises two thousand

meters in seven minutes (about 7000 feet), and dives almost vertically from this height, experiences a tremendous strain which, in time, is apt to cause weakness. Fighting machines have to perform extraordinary feats in pursuing the enemy. They dive vertically, and if the wings break under the pressure caused by these conditions, the machine at once falls. German machines, generally speaking, have a good factor of safety in their different parts. Many accidents have been caused after a machine has had many repairs, or through some

untarily contribute to the success of our pilots, and thereby deserve our thanks.

The German "aces" generally fight in conjunction with a squadron of accompanying machines. These are charged with the duty of occupying the attention of the enemy until an opportune moment for attack. Boelke adopted the following tactics, as described by M. Jacques Mortane. The German flew with an escadrille of five or six good pilots on Rolands, Walvets, or Fokkers; he preferred a Fokker, but sometimes was seen on a Roland, or a small Aviatik. As soon as the well-known profile of an Allied machine was seen on the horizon, the squadron rose to engage it. The duty of Boelke's support was to surround the enemy and block his path. They would fire from all sides, suddenly ceasing the instant Boelke made his entrance upon the scene. The latter would dash at his prey and attack furiously, firing a thousand cartridges from his machine gun. Boelke followed up the fight, in contrast to the

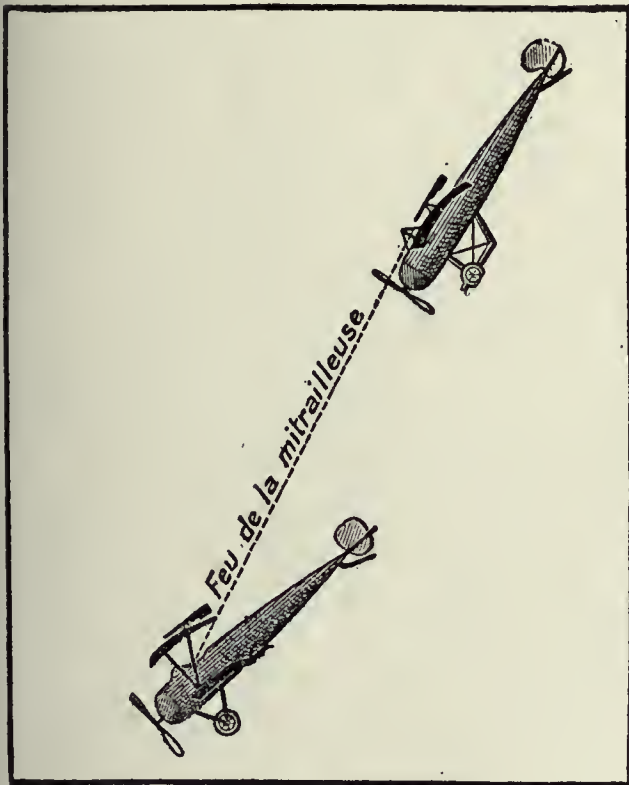

Fig. 3—The "Dive Attack." To train the machine gun upon its target below the machine must be pointed down at least 60 degrees.

hidden fault of construction. Recently at the front near Verdun an aviator was pursuing a German machine and, in his turn, was pursued by a small Rumpler biplane. At the moment when the French pilot, after bringing down his first adversary, was preparing to face this new assailant, the Rumpler dived straight toward the earth in a sudden bold dash. The wings broke and folded up above the fuselage. Many Rumpler machines have met the same fate in other air battles. The constructors thus invol-

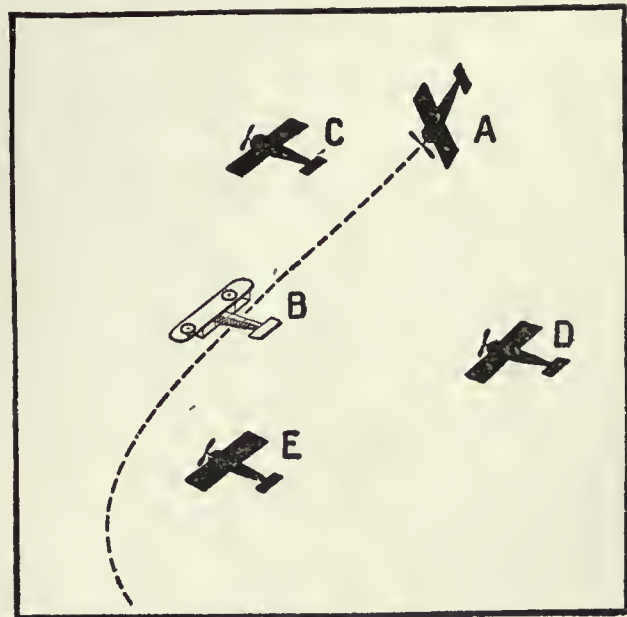

Fig. 4—The tactics of the famous Boelke. The duty of the machines C, D, E, is to surround their adversary B at a given moment. A, who has been hidden from the view of his adversary, dashes at him, firing his machine gun furiously.

custom of many of his compatriots. These rarely continued an engagement with an adversary who was not brought down at the first shot. Such was the method adopted by Lieut. Immelmann, one of the best of the German aviators. He would dash up to an enemy's

machine, and when so close that a collision seemed imminent, would discharge his machine gun at it as he passed by. Once out of range he would not return to the attack, but would fly away, which cannot be considered very heroic.

The Germans usually fly very high. When they see French machines they hesitate to cross our lines, which are always well guarded by our fighting machines, especially during the periods of Allied drives. The weather plays an important rôle in air fighting. Calm days, when the sky is full of dark, gray clouds, are the most favorable for surprise attacks. The clouds act as a screen and allow the aviator to hide until the last moment, before he makes a dash at an unsuspecting enemy.

The Germans are well versed in one trick which they invented and which they have often used. When the bank of clouds is thick, one of their machines flies down to an altitude of two or three hundred feet. This machine may be of any class, but it is usually a slow machine of an old type, and not heavily armed.

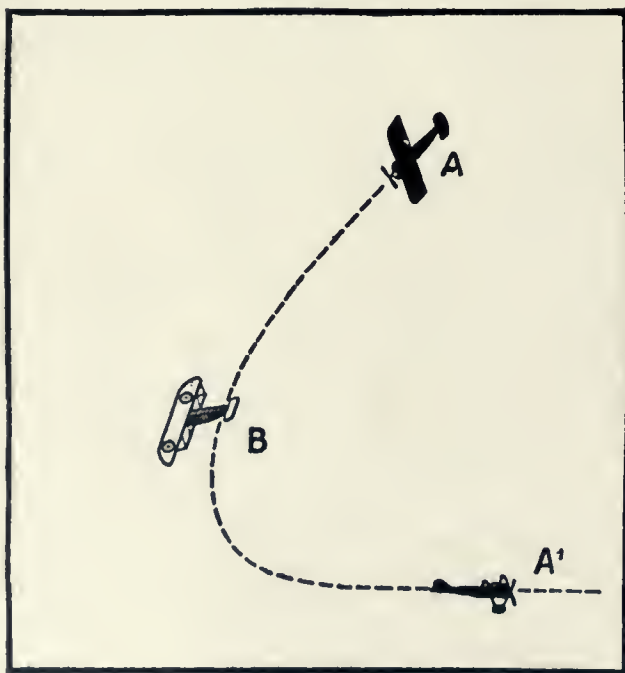

Fig. 5—The Tactics of Immelman. The machine A dashes straight at its enemy B, firing at him furiously. If he failed to bring down his prey he fled and did not return to the charge.

It appears to be relatively easy prey, and is quickly discovered by the French machines. They give chase, not hesitating to follow it,

even to some distance behind the German lines. At the moment when the French pilot finds conditions most favorable to begin his attack, three or four German fighting machines of the latest and most formidable model appear. Flying above the clouds, they have been following the two antagonists while hidden from view, and never appear until the enemy is at least twenty or thirty kilometers from his base. The number of attacking machines, and the difficulties in getting help in time, make it an extremely precarious predicament for the French aviator.

An air battle does not necessarily end by the complete destruction of an enemy machine, or the killing or disabling of a pilot. A case has occurred where a German aviator was attacked by a French "ace." The German was convinced that he had no chance, lost his nerve, and preferred to come down in safety to having his body riddled with bullets. He directed the observer with him to throw up his hands, while he steered his captured machine, and following his vanquisher to the nearest aviation field, landed by the side of his captor. In this way Lieut. Laffon gathered out of a clear sky a Fokker of the latest model, and brought it to the aviation center of Plessis-Belleville. The feat was all the more remarkable and creditable to the officer because he had no arms aboard, except a revolver.

Before the war the question of arming machines received only superficial study, at least in France. At the beginning of hostilities only a few aeroplanes were equipped with machine guns. Many of the aviators had only a rifle with which to defend themselves against attack. To-day, as the enemy well knows, our machines are very efficiently armed for both attack and defense. The position of a machine gun on the aeroplane plays a great part in the success of air fighting. We know that the Germans have studied the problem with great care, and their machine guns are mounted in one of the five following positions:

- (1) Above the upper plane (machine guns stationary, firing through the propeller).
- (2) Along the fuselage (gun stationary, shooting through the propeller).

(3) In rear of the lower plane (guns movable in a revolving turret).

(4) In front of the cockpit (gun movable and able to fire in all directions; single-motored machine with a pusher propeller).

(5) Both in front and in rear of the cockpit (gun movable; twin-motored machine, tractor propellers, with a central cockpit).

The first arrangement has been adopted by several manufacturers of small speedy bi-planes in Germany, and is similar in almost all points to the system used on our Nieuports. The machine gun is stationary on the upper plane, parallel with the fuselage, and is controlled by a "Bowden" flexible wire control fastened to a rod beside the pilot. To train the gun upon its mark in the vertical plane one must point the aeroplane up or down; and to aim in the longitudinal plane, the aeroplane must be pointed in the direction of fire, since the gun is firmly mounted on the axis of the machine. When the aeroplane attacked is just below the pursuing machine, the latter must dive vertically and attack its adversary while inclined at ninety degrees, in order to bring the machine gun into range. In practice, the angle of attack is not quite as steep as this, for the attacked machine is not exactly beneath its adversary's gun. It is at least 100 meters (300 feet) away, and when the attacking machine opens fire, it

angle. The difficulty of hitting the mark is great, since the gunner and his object are moving rapidly, and the movements in steering an aeroplane are complex and relatively slow. The mounting of the gun on the upper plane is best adapted to the machine which has the

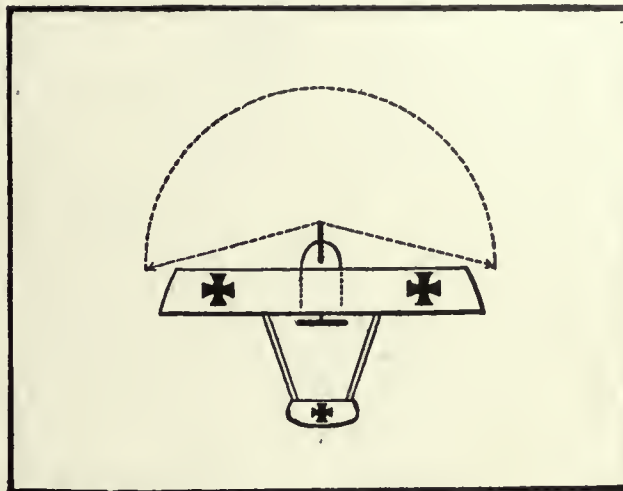

Fig. 7—Arrangement of a machine gun with a limited field of fire. The gun is mounted in front of the car on an elevated support. The field is limited by the extremities of the aeroplane.

pilot's seat behind the wings. Consequently, to gain the best chance to reach the aviator himself, his adversary must strive to attack from above.

The mounting of guns for firing through the propeller was first attempted by Roland Garros, who was taken prisoner before he was able to destroy his machine. The Germans were quick to copy this method of mounting guns, and have made many improvements, as it was well adapted to the Fokker machine and gave very good results. On the Fokkers, the gun is mounted stationary above the hood, a little to the right of the axis, on a level with the head of the pilot. The propeller causes only slight inconvenience, but on account of the gun being firmly fixed, the entire machine must be aimed, with the attendant difficulties already mentioned. It is also possible to shoot through the propeller by using an automatic device to momentarily stop the fire during the passage of the propeller-blade in front of the gun. The latter is mounted directly behind the propeller. In this device the motor is connected with the machine gun, and a cam controls a mechanism

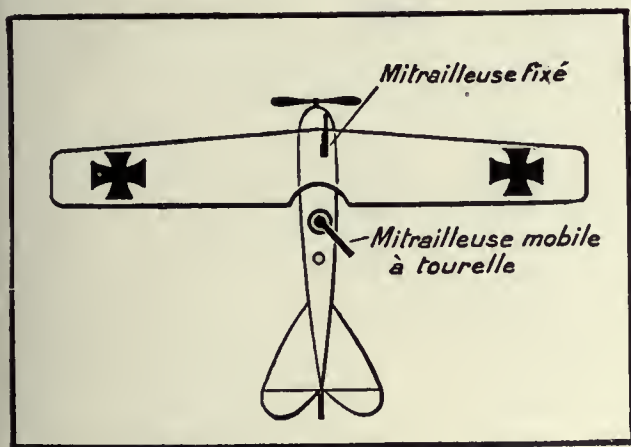

Fig. 6—Mounting of the two machine guns on the new bi-plane L. G. V. The machine gun in front shoots through the propeller and is fired by the pilot. The rear gun mounted in a revolving turret is fired by the observer.

is at an angle of 55 or 65 degrees. This, when compared with the horizontal, is a considerable

which stops the fire for $\frac{1}{500}$ of a second, while the blades of the propeller are in the path of the bullets. When the propeller has passed, the gun is free to fire again. If a pilot wishes to shoot, he presses a small lever placed on the steering post, which is connected to the trigger of the gun.

The company licensed to make the Nieuports

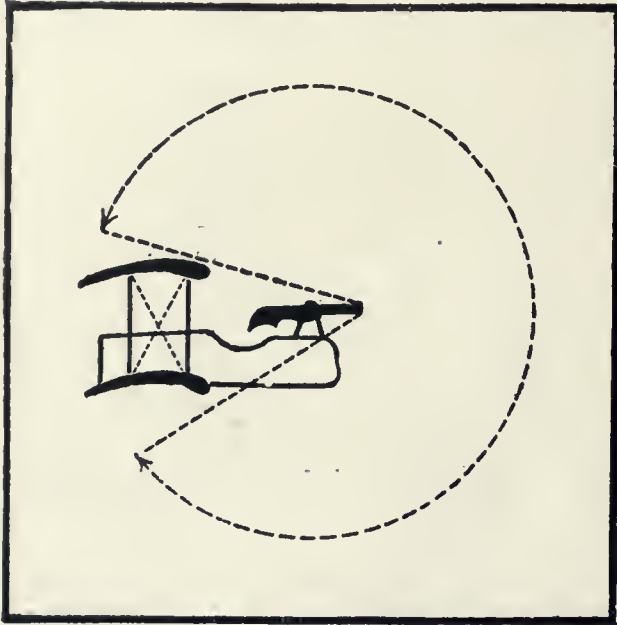

Fig. 8—Vertical field of a machine gun mounted on a pivot. In the vertical plane the fire is very extended. It is only limited by the parts of the aeroplane.

in Italy recently invented a device which enables one to shoot through the propeller, practically identical with that used on the Fokker. It is based on the difference between the speed of the gun and the speed of the propeller; that is to say, the ratio between the bullet and the propeller-blade is 700 to 160. This difference is used to regulate the stopping of the machine gun during the passage of the blade of the propeller in front of the barrel of the gun.

The arrangement which Garros used was extremely crude. It consisted simply of a small piece of steel, hard enough to resist a bullet, placed on each blade of the propeller opposite the barrel of the gun. If a bullet chanced to hit the propeller, the metal deflected it without causing damage to the propeller-blade.

The German bi-planes, like the L. V. G., for example, have two machine guns. One is stationary on the upper plane, the other movable

and mounted on the fuselage behind the observer's seat, on a revolving turret. This gives it a great range of fire. The turret is a ring of wood which turns freely around the cock-pit on ball-bearings, with a bracket arm which holds the gun and permits it both to be trained in the vertical plane and swung around in the horizontal plane to either side of the fuselage, so as to point in any direction. Two small clamps hold the turret and gun firmly in any position. This arrangement gives a wide range of fire toward the rear in all directions, and on either side, both above and below. It is even possible to fire ahead, above the wings of the machine. The rear machine gun is often replaced by a "fusil mitrailleuse," or automatic rifle. To protect the blank sector of this gun arrangement, the fuselage is provided with a tube-like opening, inclined at an angle of forty-five degrees. This tube allows the gunner to see and fire through the fuselage at the enemy, if he tries to hide from view of the gunner below the rear of the machine.

The machine guns, when mounted in front and rear, are both fired by the observer, but in a recent type the forward gun was placed between the two planes beside the motor and parallel to it, being fired by the pilot.

At the beginning of the war some German machines had a cockpit, like the French Farman's, with a gun mounted on an elevated support. This mounting left a large blank sector of fire, and was afterward abandoned. The gun did not have much sweep, and its zone of fire was restricted by passengers, wings, propeller, cables, struts, etc. This was remedied in a measure by mounting it on a turret, which allowed it to fire in all directions, but not at all angles. This type of machine is not used today at the front. It has been replaced by the A. G. O., which is provided with two motors and tractor propellers, and a central car armed with two machine-gun turrets. One machine gun is placed forward, sweeping the horizon for 180 degrees and the other is in the rear, its range also controlling 180 degrees of the horizon. Between them the entire horizon is covered. All of the German machines are armed with one or two Maxims, Lewis, or Parabellum machine

guns. Some aeroplanes have three machine guns, and these are considered the best for actual service. The Parabellum has a belt of cartridges which contains not less than a thousand projectiles.

If each pilot has his own method of fighting, each type of machine has its weak points; and these points must be well known, in order to make a successful attack upon it. When attacking a machine it is necessary to learn how its guns are mounted, in order to know whether to attack it from above, below, or from the side. If the field of fire of the machine gun has certain dead points, it is thereby handicapped, and may be attacked to advantage. A pilot who is attacked by an Aviatik is exposed to fire from all directions, except in the zone in front of the propeller. In the case of ordinary Aviatiks, with the gunner in front, the machine gun can be placed at will on the right or left side of the fuselage. It is placed upon a pivot mounted on a carriage. This carriage can be moved on two guides, or slide bars, that run along the fuselage to a convenient point for firing. A clamp holds the carriage at any spot, so that one can fire in all directions. An aviator who attacks an L. V. G. which, as we have explained, has two machine guns, must decide whether it is better to stay in front or in the rear of the

line of fire between the forward and the rear gun.

Thus we see that the identification of the type of enemy aeroplane is absolutely necessary for

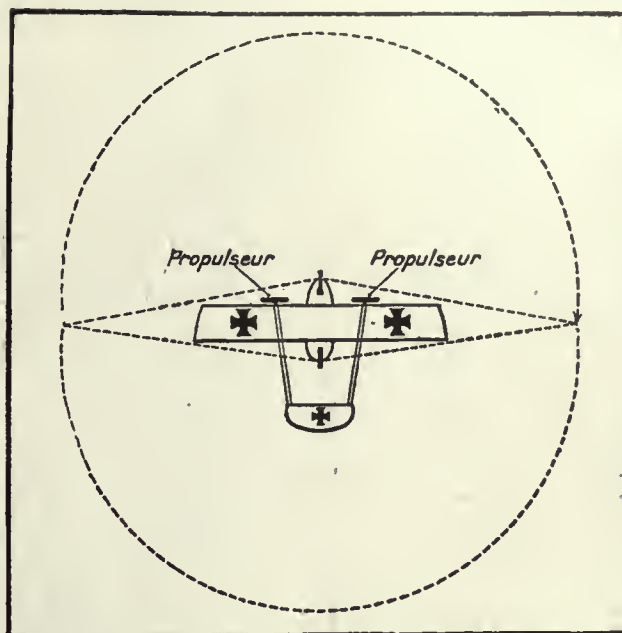
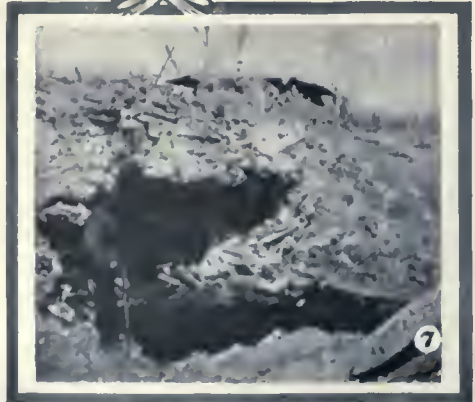

Fig. 9—Mounting of two machine guns in a bi-motored machine. The arcs of fire in the horizontal plane meet each other when the guns are mounted in this manner.

an air warrior. Unfortunately, the diversity of types of machines employed by the Germans, and the frequent changes made in service, renders this identification extremely difficult.



German positions reduced by French artillery through the directions given by aero observers. The center photograph shows the trenches and German position in broad perspective. The important positions are shown by numbers and are shown in detail in the smaller photographs. The aero observers directed the artillery fire on these positions.



Photograph No. 1 shows the effects of the French shells on a typical one of many German points d'appui. No. 2 shows the condition in which the captured German trenches were found. No. 3 shows the remains of the emplacement of a German battery. No. 4 shows the ruins of a small but very strong German fortified post. No. 5 shows the result of the French bombardment on the German defensive line before the River Sulppe. No. 6, like No. 2, is another typical scene in the captured German trenches, showing their general appearance after the bombardment. No. 7 shows all that remained of some of the deepest German dug-outs and trench shelters. No. 8 illustrates the demolishing effect of the French artillery fire on the solid concrete structures built by the Germans in their trenches.



An aero observer flying over the German lines in a Farman biplane. The shrapnel is bursting around him.

CHAPTER VI

DIRECTING ARTILLERY FIRE BY NIGHT AND DAY SIGNALING TO AND FROM AIRCRAFT

Aircraft are the necessary adjunct of coast and field artillery, and the aero observer is the man behind the man behind the gun. Thousands of American aero observers will have to be trained, therefore the information is given as complete as possible, so that prospective observers may familiarize themselves with the fundamental principles.

Aeroplanes and captive balloons are used for spotting artillery fire.

The observers have to perform two functions, mainly as follows:

(1) To locate the target, which may consist of hostile batteries, bodies of troops, advanced trenches, trains and mechanical transports bringing supplies or reinforcements to the enemy, temporary headquarters, or strategic positions held by the enemy.

(2) Having discovered the target, the observer directs his battery to open fire, and then notifies the gunners of the effect of the fire by wireless, if from an aeroplane, and telephone from a kite-balloon.

Practice makes it possible for the aviator and the gunners to reach such a thorough understanding that the observer need not send more than brief wireless signals, such as "short," "long," "right," "left." Likewise the gunner seldom has to fire more than three shots before hitting the target.

The observer must know something about artillery, such as the fact that field guns are used for barrage fire and howitzers for counter battery destruction.

While looking for the target the aviator may have to fly down low. As soon as he has found the target he flies to whatever height is necessary to avoid crossing the trajectory of the shells.

The aviators cooperating with the artillery are usually located at an aerodrome located from ten to fifteen miles behind the firing lines, and are instructed to be over a given place at a certain hour to spot the firing. At the time designated the aviators hover over the batteries and watch the results of the firing.

From a height of 4500 to 6000 feet the ob-

servers can usually see clearly the effect of firing of large caliber guns, but the firing of three-inch guns is very hard to detect.

Well-trained observers are necessary for spotting, as it is easy to confuse the puffs of smoke of the hostile anti-aircraft guns with the puffs of smoke of the shooting of one's batteries. The fact that the enemy's anti-aircraft guns keep up a sustained fire against the aviator, and that hostile aeroplanes may be lurking in the sky ready to plunge down on the unsuspecting artillery observer, turning on him a rain of bullets from two or more Lewis or Vickers guns, prevents the observer from giving all his attention to watching the result of the fire of his batteries.

The observer often sees what appears to be a hit on the part of his battery, but which is, in reality, an anti-aircraft gun shooting at him.

While spotting artillery fire the aeroplanes usually fly in figures 8s and circles, changing

their direction as often as possible, so as not to allow the men behind the anti-aircraft guns the chance of anticipating what direction they will fly next—because in such a case the anti-aircraft guns would be turned effectively on the aeroplanes.

While the work of spotting artillery fire requires all the faculties that the aviator and observer possess, it is not more dangerous than bombing or aerial fighting. For one thing, the machine is usually in flying distance of its own aerodrome, where it can land in case of being badly hit.

This last remark must be qualified, because aeroplanes engaged in spotting artillery fire are always hit by bullets or pieces of shrapnel.

The danger from the aeroplane catching fire is also minimized somewhat by the fact that the aviator is in flying distance of the aerodrome, although the only safe protection from fire is:

(1) To use aeroplanes the wings of which are varnished with an inflammable dope.



Directing artillery fire over the mountains. Monte Pasubio, on the Trentino front, as seen from a Caproni machine.

(2) To always have a fire extinguisher at hand.

(3) Every machine of this type should have an arrangement which permits the aviator, as soon as he is within gliding distance of a landing field, or sooner if necessary, to open a valve and let out all the gasoline and oil.

Some remarkable records have been made by aviators and observers engaged in spotting artillery fire. Among them is the record of the French lieutenant, Perrin de Brichambaut, who has been engaged in this work since the beginning of the war and in less than two years flew over the enemy lines eleven hundred hours. The record for one day was seven hours of continuous flying over the enemy lines!

Spotting artillery fire at night is more difficult in a way, but less dangerous—provided the aviator has had experience in night-flying. The targets are detected by the lights, since the enemy cannot operate unless it has lights, and even the smallest light is seen from the air. The flash of guns being fired supplies the directions to the enemy batteries. At night both the wireless and the Very pistols are used for signaling.



An artillery observer flying a Caudron biplane over the German lines, photographed from another aeroplane.

Methods and Codes Used for Communicating From and To Aircraft

The methods and codes used in communicating from and to aeroplanes change continuously, as each side quickly learns the enemy's methods and codes and any improvements made. But there are basic principles which



A few F.E.2.B machines of the Royal Flying Corps, used for directing artillery fire, ready for a flight. (British official photo.)



The observer in a captive balloon directing artillery fire. His equipment includes a chart of the sector, divided in squares, which enables him to quickly estimate the accuracy of the firing. He transmits the information to the battery commander who, in turn, orders the gunners to fire according to the information received from the observer.

vary only in detail and which every student should learn.

The pilot, the observer, or both remain close



Receiving messages from the aero observer, and transmitting them to the gunners.

to the commander, or they are notified to be flying over a certain spot at a certain hour.

An aeroplane may serve from one to four batteries. When the battery commander wishes to use the aeroplane to locate a target, he explains what he requires and, if possible, the nature of the target and its general direction. The aeroplane then rises to the necessary height behind the battery, in order to run less danger of injury by hostile fire. Meanwhile, strips of white cloth are laid out on the ground near the battery, so as to give the supposed direction of the target and other instructions. The aeroplane, having reached the required height, flies out over the battery to find the exact position of the target.

The Observer's Special Map

When more accurate definition is wanted the same method is used, but the sides are divided into 100 parts and four figures are used instead of two. Thus 0843 denotes 08 parts East and 43 parts North of origin.

These maps contain as much information as is available regarding the enemy position, the apparent importance of enemy's trenches, entanglements or other obstacles, fortified and unfortified mine craters, ditches, railways, etc.

There are also shown in different ways, first, second, and third class roads, whether fenced or unfenced; double- and single-track railways, footpaths, car tracks, buildings, conspicuous points, elevations (which are given in meters), etc.



A French gun of large calibre being fired.



A captive balloon observing and directing artillery fire somewhere in France at dawn.

There are also shown the location of trenches and other prominent positions of the observer's own forces, as it is necessary that he know these. While it is true that if the enemy captures one of these maps he obtains information regarding positions, it is also true that the enemy usually already has that information, since no such supremacy has as yet been obtained as to prevent an occasional aeroplane from taking photographs or observing—if only from the enemy's lines, with the support of the anti-aircraft guns.

Signaling With Very's Lights

When radio fails, Very's lights are used. In this case the observing aircraft should remain

close to their own guns, at the best height for observation, in order to facilitate communication. In some cases, however, it may be necessary to fly out further toward, or even over, the target in order to insure accurate observation. In such cases much delay will ensue if the aeroplane has to come back over its own guns to signal the results; on the other hand, if it remains out in the front, the signals may not be seen.

The observer having located the position of the target and conveyed the information to the artillery commander, receives from him the signal "Observe for line."

The aeroplane now moves, keeping on that



An officer of the British Royal Navy Air Service shooting a Very pistol, used for signaling from the aeroplane to the ground and between aircraft.

side of the battery farthest from the sun, so that the signals can be easily seen.

Rounds can only be seen with ease when the aeroplane is moving out toward the target. If the distance A to B is about one mile, two rounds can be observed during each outward flight. As soon as the line is obtained the signal "Observe for range" is sent. The aeroplane now moves in an elongated figure of eight, always turning toward the target. It will keep

behind or in front of the battery, according to the position of the sun.

Range having been obtained, the signal "Observe for fuze" is sent, etc.

When the signal "Land" is sent, the aeroplane comes down at a place previously selected and not necessarily at the spot whence the signals are sent.

Two men should be detailed from the battery to watch the observing aeroplane, one with field-glasses looking for the signals, the other with his naked eye keeping a continuous watch on it, so as to make certain that no mistake is made as to the actual machine, since, when there are several aircraft out in observation, confusion between them is very likely to arise.

With Very's lights the following code of signals may be used for communication to the ground.

Kite-Balloons for Spotting Artillery Fire

Kite-balloons are used extensively for spotting artillery fire. The kite-balloons are usually located a few miles behind the lines and the balloons are sent up to a height of about two thousand feet, from which the observers have a broad perspective. For close-range observing the kite-balloon observer can do more accurate work than the aeroplane observer. That is also true about observing at night. The kite-bal-



U. S. Army Aeroplane No. 50 of the North Island aviation school which was one of the aeroplanes which was equipped by Capt. C. C. Culver for radio work, the aerial wires being shown above the upper plane in the picture. Lieut. Herbert Dargue, U. S. A., is seen at the pilot's wheel, while Major Frank P. Lalm is in the observer's seat. The officers had just completed a flight.



Rigging up the wireless receiving post between two wireless motor trucks "somewhere in France."

loon observer, having knowledge of his own position, can easily figure out the location of any light which he may see, or of the flashes of hostile guns. The kite-balloon observer transmits the information by telephone to the officer below, who transmits it to the battery.

The Dubilier-Goll Semi-Radio Telephone System for Captive Balloons

Communicating from an observer's balloon to the battery commander is usually done by means of the regular standard telephone instruments operated by a few dry cells, using two wires, the same as with the ordinary house telephone. The holding cable of the balloon, which is used for hauling the balloon up and down, is especially constructed in such a way that it has a small insulated wire in the center, which is used for the return circuit. This insulated wire makes the cable not only expensive, but weak in construction, especially when over 2000 feet are used, when the strain on the cable can be seen from the height of 3000 ft., and a prearranged code of signals can be made by this means.

Very's lights fired from the ground can be seen from aircraft with the same ease as those fired from the air can be seen from the ground, if the observer knows exactly where to look for them.

Signaling between Aircraft

It is possible to signal between airships with a signal flag by semaphore or Morse code, pro-

vided the aircraft are broadside to each other, and not over 1000 yards apart.

Between aeroplanes, Very's lights can be used in accordance with a prearranged code.

Major C. C. Culver, U. S. Army, who has done much important pioneer work in radio so applied to aeronautics, and is mainly responsible for placing the United States foremost in this science, has evolved a method which permits intercommunication between aircraft in flight by wireless telephone.

Cooperation between Balloons and Artillery

By Major D. RAINSFORD HANNAY
British Royal Flying Corps

Courtesy of "Aerial Age Weekly"

It is a very well-known axiom in war that the closest co-operation between the various arms is necessary to secure the best results; and, when it comes to the question of captive balloons observing for artillery, the more that each unit knows about the methods of, and the difficulties experienced by, the other the better.

I propose, therefore, to describe the working of a balloon section of the British Army in the field.

As regards organization, the balloon service of the Royal Flying Corps is divided into wings, companies, and sections. A section consists of four officers and 90 men and works one balloon. A company consists of two sections. A wing consists of all the companies in any one army.

The balloon now in use in the field is a stream-

line balloon, the invention of Captain Caquot, of the French Army. It has a cubic capacity of 950 cubic meters and is capable of lifting two observers to a height of 4000 feet. Each section is provided with a mobile winch, the engine of the winch being quite separate from the engine of the truck on which the winch is mounted. Theoretically, the balloon should be let up from

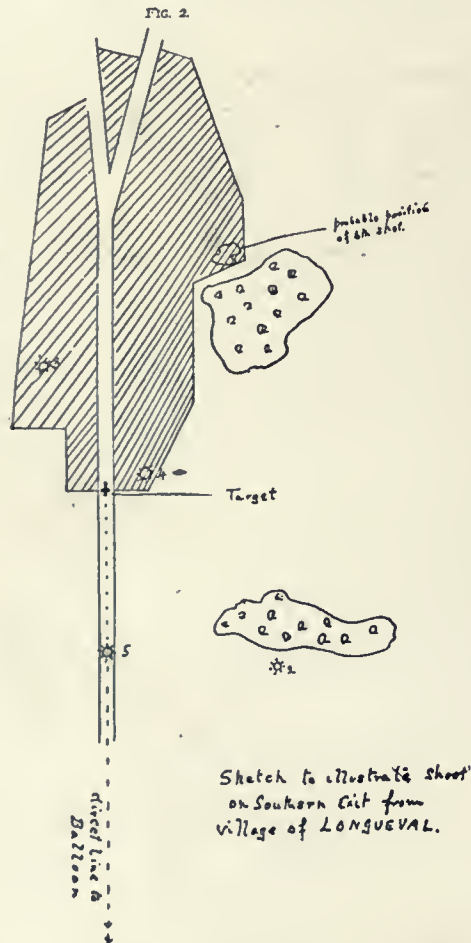

the ground at a considerable distance behind the lines and then run forward on the winch with the balloon high up in the air; but, in practice, it is found that there are very few roads left near the lines which are fit for a heavy truck, and, even if one is found, it is probably too congested with traffic. Owing to these reasons, the majority of balloons, in France, are stationary, at an average distance of about 6000 yards behind the line. Where sections have been able to move their winches forward, they have got within 4000 yards of the front line.

As regards observation of fire, the work of

the balloon observer is chiefly with the heavier pieces of artillery, such as the

- 6-inch howitzers and the 4.7-inch guns,
- 8-inch howitzers and the 60-pounder guns,
- 9.2-inch howitzers and the 6-inch guns,
- 12-inch howitzers,
- 15-inch howitzers.

In the earlier days of the war, when there were fewer heavy batteries, balloons used to observe for Field Artillery; but, owing to the great increase of the howitzer batteries, and, also, to the somewhat altered rôle of the Field Artillery, very little work is done with them nowadays. In order to avoid confusion, Field Artillery in the British Army consists of only 18-pounder guns and 4.5-inch howitzers.

The balloon section is connected by telephone to all the batteries with which it is likely to work. The sketch gives a typical communication scheme of a section in the field. The upkeep of the telephone service is most important, and it is necessary that batteries should give as much mutual assistance as possible. Unless the lines are working well, the balloon might as well be on the ground, for all the good it can do. An advantage which a balloon has over an aeroplane, and one that compensates for a great many of the disadvantages, is the fact that the observer in the basket can talk direct by telephone to the battery commander on the ground, and does not have to confine himself to a limited code as used on the wireless. To refer to the sketch, all the telephone lines, shown, with the exception of those to Corps Heavy Artillery Headquarters, are the shooting lines of the section, and are used only when observing for, or when arranging shoots with, batteries. Lines lead from the balloon camp exchange to an advanced exchange which is placed in a central position among the batteries. Now when the balloon is in the air, it is connected by a telephone cable to the winch, which is, in turn, connected by aerial line to the camp exchange, and, tapped in one this line, is the chart room of the section, where all the map work and the arranging of shoots with batteries are done.

I have purposely enlarged on the communi-

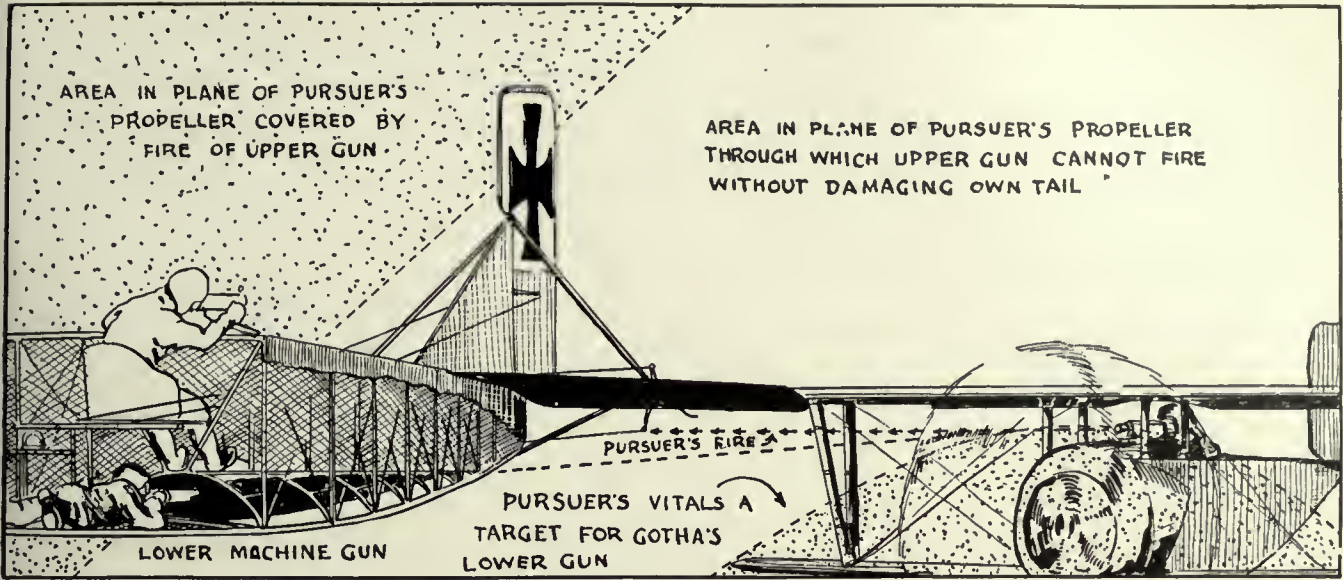

How the Gotha Gunners protect the rear or "blind" side from attacks.

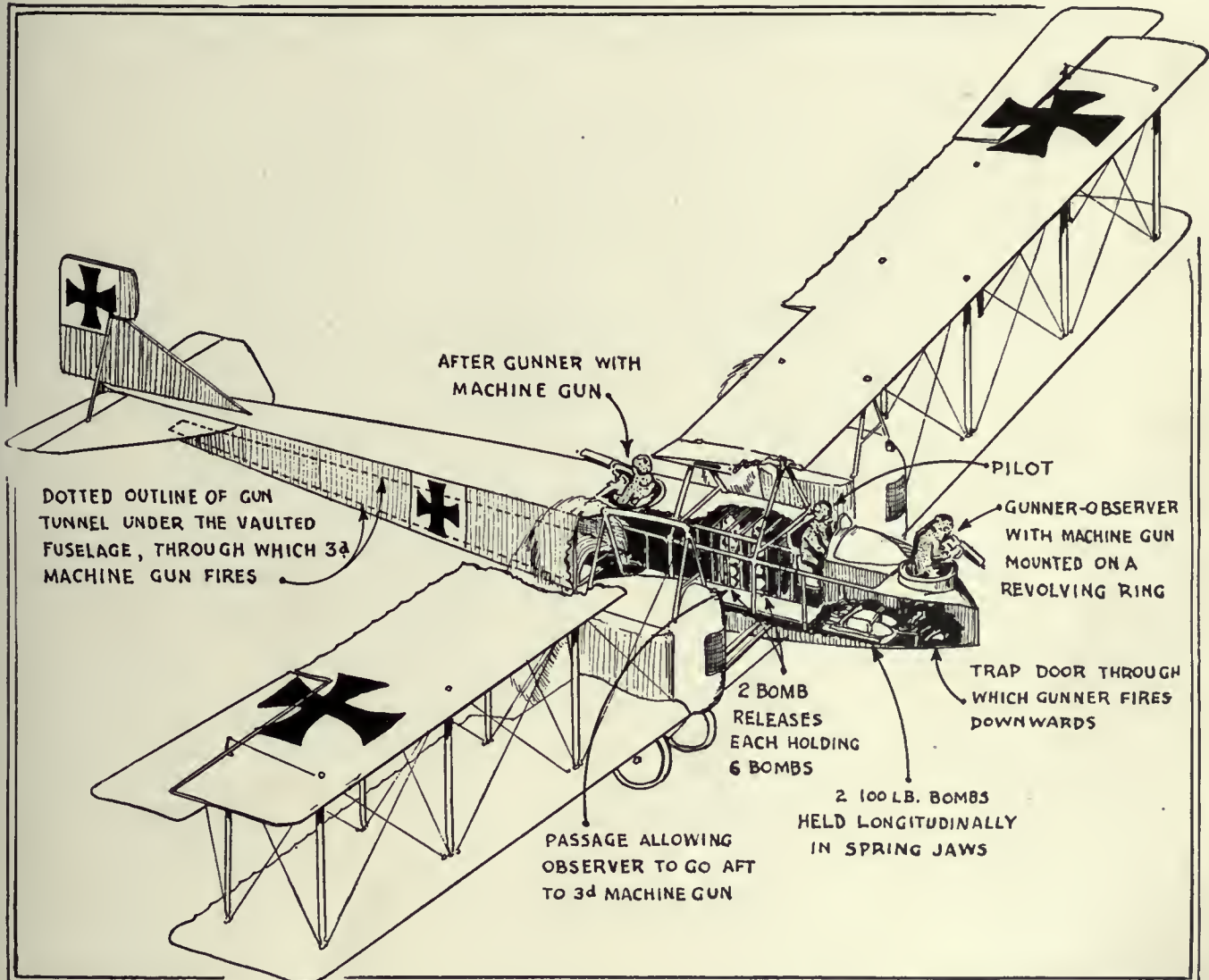

The German Gotha battleplane, famous for its raids on British soil.

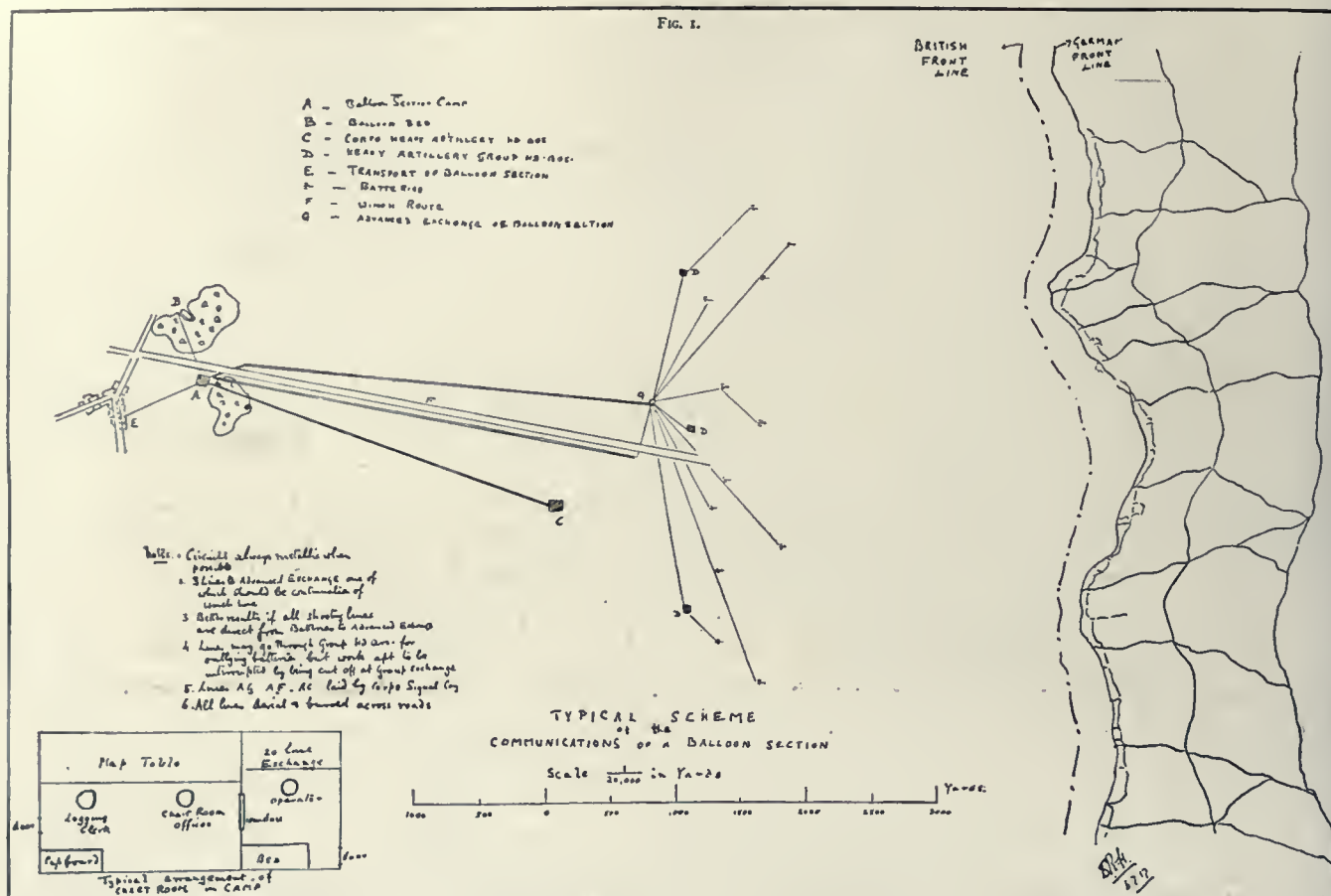

communications of a section for this reason: although the greater part of the lines are laid by the signal companies, when once laid, the balloon section is responsible for their upkeep, and it will be seen, on referring to the sketch, that it is a pretty big job for the small telephone detachment allotted to a balloon section. Therefore it is of the greatest help when batteries assist, as much as is in their power, with the laying and maintenance of the line from their position to the advanced exchange (see Fig. 1).

The work chiefly allotted to the balloon consists of:

1. Destruction of villages;
2. Destruction of strong points behind the line;
3. Registering on cross roads;
4. Registering on exits from villages, woods, and ravines;
5. Counter-battery work.

The method of observation employed it to observe on the line balloon-target, and, by the use of gratieuled glasses, to send to the battery such observations as

- 1°20' Right,
- 30' Left,
- Line and over,
- Line and short.

When the battery sends "Gun fired," the chart room officer sets his stop-watch going and says, "Bum fired" to the observer, then, at the correct time: "10 seconds to burst"; "5 seconds to burst"; "4"; "3"; "2"; "1"; "Burst."

This relieves the observer in the balloon of watching with his glasses the whole time. He must keep his eyes fixed on the target, but need not strain them by peering through his glasses during the whole time of flight. When he hears "10 seconds" he gets ready, and at "5" puts them up.



A French captive balloon of the Caquot type just behind the firing lines.

CHAPTER VII

KITE BALLOONS —THE EYES OF THE ARTILLERY

Written by a French Officer; Translated by Augustus Post

(From "Lectures Pour Tous")

Another of the marvelous developments of the war is the captive balloon, which, in view of the wonderful progress made with dirigibles and aeroplanes, seemed doomed to be relegated to the storeroom. Captive balloons, on the contrary, have developed with the increasing importance of artillery until we now receive most valuable service from our "sausages," which are exposed to great dangers and whose officers have had most dramatic adventures.

Holding the lines of the enemy under continuous observation, transmitting to the commander every operation that goes on, directing artillery fire—this is the rôle that the captive balloon plays. Before the beginning of the war, the Germans had foreseen their value and although we had only spherical captive balloons, they were already using the elongated shape, familiarly called "sausage." As is the case with many other inventions, this model was originally French, and was copied and adapted

by the Germans under the name of "drachen," or "kite" balloon. It has proven its superiority since the spring of 1915, because it acts exactly as a kite and is supported by the force of the wind, when a spherical balloon would be beaten down by a wind of from eight to ten meters a second.

Manoeuvring

A balloon company consists of a crew, who take charge of the manoeuvring of a kite balloon; that is to say, filling, observation, transporting, and making the ascension. In addition, there are several wagons and automobiles. The most important is the "voiture-treuil," or "windlass wagon." A steel cable about the size of a pencil, that can stand a heavy pull, is wound up on an immense reel. In the center of this cable is a telephone wire, connecting with the basket. A motor turns the reel

in one direction or the other to allow the balloon to ascend, or to draw it down. The automobile windlass has almost entirely superseded the old-fashioned steam winch with six or eight horses; it moves three or four times as fast, needs not more than ten meters to turn, and is less vulnerable. Always ready, it is easily concealed with a cover of branches.

Camp Equipment of a Kite Balloon Unit

When the balloon is in use, the "treuil" is accompanied by a "camion aux agres," or "rigging truck" containing a store of extra ropes, the basket, the "godets," or cup-shaped pieces which are attached back to back and make an immense kite-tail to head the balloon into the wind. The equipment includes the field-glasses, maps, and scientific instruments. Besides the windlass wagon, there are two equally important wagons that hold the encampment paraphernalia and the telephone equipment. The first has all the things necessary to set up a new observation station when the old one has to be abandoned for some cause—shell-fire, for instance, coming too near. They carry corkscrew stakes and pegs which hold the stays of the balloon, sacks of ballast, a ground-cloth to prevent the balloon touching the ground, and all the other things that are a necessary part of the equipment. In one day a company changed its location four times, because the positions were shelled each time after the balloon had been set up and inflated.

The telephone car contains all the material necessary to establish communication,—miles of wire, apparatus, tables, bells, spurs for climbing high trees, insulators and brackets for laying lines to connect the balloon with the commander of the artillery or batteries of anti-aircraft guns, if they are a long way from the place of ascension.

An Artillery Captain's Experience

During an advance, the observer in the basket is directly in touch with the gunners and regulates their fire, a very interesting occupation for the observer, especially when it is necessary to pick off some convoy or troop on the march. One day an old captain of artillery who had little confidence in the usefulness of the captive balloon was invited to ascend, in order to see how easy it was to control the artillery fire. They had not ascended one hundred meters before he marveled at the panorama, at three hundred he was converted, at eight hundred he was enthusiastic. The observer who accompanied him kept revealing new possibilities to him all the time. The time passed until the officer commanding the company of the balloon corps saw his telephone operators bursting with laughter. He called them to order, thinking that they were telling each other funny stories, but one of them said to him, "Take the receiver and listen to the observer and the captain in the balloon." They were directing fire upon a long train on the march, at the extreme range of a battery.



One of the monster British guns on the Western front. The efficiency of these guns depends entirely on the spotting of the aerial observers, therefore. The Kite balloons are usually stationed in the rear of heavy artillery, held anchored by means of cables. The observers in the basket of the balloon have a clear view of the enemy's position and observe the results of the gun firing, and advise the battery commanders by telephone.



Photograph taken from kite balloon showing how the earth appears to an observer.

The captain was amazed and could not restrain himself. "*Bang!* in the center; one wagon demolished. Oh! and the horses—*bang!*—another. Eh!—Ah! it is wonderful, wonderful. I never believed it. *Bang!* At least, we do not fire blindly."

Personnel of Kite Balloon Company

The personnel of a company of balloonists is divided into two classes of about equal numbers; that is to say, the men who pull on the ropes, and the others. In order, they are: the captain, sometimes a lieutenant, in command of the company. It is he who, assisted by his officers, chooses the best point for observation and the most convenient for locating the balloon and the camp. Under the direction of the officers, the sergeants assign the corporals to their ropes, and lay out and transport the balloon over obstacles. Eight men handle the envelope, and the rigging, place the basket, and adjust the maps and instruments, four or five mechanics work the winch, and one cyclist and one motorcyclist serve as messengers. As in all other troops, there is a doctor, a quartermaster, a furrier, tailor, shoemaker, barber, orderlies, and all

the little world of specialists who go to make up an efficient unit.

Preparations for Ascension

When a company arrives at a new position the captain, accompanied by his observers, immediately gets in touch with the commanders of artillery, inquires the location of the enemies' batteries, their habits and activities, and the strength of their artillery and aeroplanes. In another direction a mounted officer with a detail-map searches for a good location to station the balloon. This is a very delicate matter to decide. The best place is in a forest, which protects the balloon from high winds. Trees are cut down to make a clearing large enough for the manœuvres of ascending and descending without risk of tearing the envelope on the branches, and for leaving room to handle the tail of parachutes. Next the work of making camp is begun. The ground-cloth is spread, ten stakes set, to attach the balloon, 80 ballast sacks of ten kilos are placed with their hooks in the network, and a bag containing the balloon is placed in the center of the ground-cloth. The valve is attached, the cords straightened out,

and the filling pipe securely connected. All this takes about half an hour, and the balloon is ready for inflation. Hydrogen is brought in from the tube wagons, each tube containing 150 cubic meters of gas, compressed to a small volume. It takes over one hundred tubes to fill the balloon, and from two to three hours, unless you have enough tube wagons, when it can be done in half an hour. When filled, the "sausage" is ready to ascend, if the weather permits and the wind is moderate.

In fifteen minutes the balloon is in the air, not to come down till nightfall, and the regular routine of life begins. At daylight the company return to the balloon. Some detach the ropes from the fastenings and unhook the bags of ballast which hold it down, while others connect the appendix, and replace the gas lost during the preceding ascension by expansion, due to the altitude. This takes only fifteen or twenty minutes at most, and soon all is ready for another ascension. When circumstances permit, the balloon remains in the air all the time, with one or two observers who take their meals with them. As night falls, or when the weather renders it useless to remain in the air, or dangerous storms with rain or high winds, come up, the balloon is brought down, disconnected, and made fast for the night under the watch of sentinels, so that the rest of the men can return to camp. Frequently, it is necessary to remain up all night,

to search out the batteries of the enemy by the flashes from his guns. An observer who has passed many days in a balloon becomes familiar with the country, and can determine in the dark various points in the landscape and tell where certain woods and villages lie, or he can even locate very exactly a battery whose position could not be located in the daytime. This routine continues with great regularity, until the company receives orders to take up a new position. In three or four hours at most the convoy is on the march, the balloon being deflated in twenty-five minutes, and packed in its sack, and all other materials loaded on the wagons.

What You Can See from a Kite Balloon

Here is a story of a lieutenant of artillery on his first ascension.

"The order to 'let go' has been given. My basket is a charming little boudoir, hardly big enough to take two steps in. At my hand, literally, are three binoculars, maps, and the telephone which connects with the ground and puts me in direct connection with the commander of the artillery station. At my feet, I see my companions looking up, with their heads thrown back. The perspective rapidly extends. The horizon, limited by the trees and surrounding hills, slips farther and farther away; the landscape stretches out below in relief; the picture changes to a geographical map, but the map is



One of the hundreds of French motor batteries en route to its firing point, the fire of which is directed by Kite balloons and aeroplanes.

vivid and brilliant with soul-inspiring color; serpentine roads and rivers stretch away in the distance. Just below me is a farm, and those minute dots are animals. In the east, a few kilometers away, are the zigzag lines of the enemy's trenches; they cross and re-cross. In the center runs a slender green ribbon which seems to be intact. This is the ground between the trenches of our first line, and the enemy. Here and there are some ruined villages, the houses demolished. The desolation of the scene makes one feel sad. Scattered all about, we can see black and white places. These are the shell-holes, where the enemy has trained a battery upon some spot and sprinkled it with terrific fire. There are also our own works, and batteries which we know well by the puffs of smoke when the guns are fired. From the basket all this is perfectly clear. It is the ideal observatory for artillery. It is true that the basket is not always above the positions of the enemy, as is the case with the aeroplane, but it is stable, and you can use glasses without difficulty. There is also another great advantage in that the observer is in constant communication with his batteries, which is more accurate and rapid work than in the case of the aeroplane."

Aeroplane vs. Captive Balloon

The captive balloon has a dangerous enemy—the aeroplane. When the weather is clear and



An aeroplane having approached the balloon, the observer has jumped into space and is descending by means of the parachute.

the clouds high, the aeroplane is not a formidable enemy. The telephone signal and white puffs of smoke from the "75's" give warning from afar. If the balloon is too high, it is hauled down 300, 400, or 500 meters, but not down to the ground, for if it is on the ground, the enemy aviator has only to consult his map

A French Kite balloon being inflated. The Germans were first to employ Kite balloons for directing artillery fire. The Allies promptly adopted them and now there are thousands of Kite balloons in use on both sides and are considered absolutely invaluable. The English call it "Kite balloon," the French "balloon captif" or "saucisse," the Russian "Kolbasa," the German "drachen," the Italian "Pallone — Cervo Volante."



and altimeter to know his exact height above his target and release his bombs with some chance of success. If the balloon is at an unknown height, it is impossible for the aviator to calculate the instant to let fall his projectile. When he descends low enough to attack with his machine gun, he must risk being hit by the observer's gun-fire and the machine-gun below the balloon. Descending to 2000 meters is dangerous for the aviator, but there are some exceptions of which the following incident is one:

Last March, in ideal weather, the balloon of the —Company was in a clear sky at sunset. Suddenly the signal came that a German aeroplane was seen on the horizon. In truth, all one could see was the white puffs from the "75's" shells, high in the sky. But soon the silhouette of an aeroplane appeared, making right for the balloon. A whistle, two or three sharp commands, and the windlass commenced to haul in while the machine-guns and muskets were trained on the aeroplane, and the observer warned by telephone. There was no more doubt, for not only had the aeroplane headed for the balloon, but again, without heeding the bursting shells, pointed directly at the "sausage." Descending with great daring to the same height, so that it was difficult for the anti-aircraft guns to regulate their fire, the machine-guns only were brought into action. In the basket Adjutant T., just promoted, prepared

to christen his *chevrons*; his carbine came into play. Seeing the balloon descend, the German aviator volplaned down, so near that we hoped each instant he would be caught in the maneuvering rope. While turning, the aviator was furiously firing his machine gun. As luck would have it, the carbine of the observer jammed. He kept cool, however, which was easily done, for it was 6° above zero, and calmly sat down in the bottom of the basket trying to fix his gun. Believing him wounded the "boche," despite the bullets which whistled around him, tried to set fire to the "sausage" with a specially constructed cannon. He launched an incendiary bomb, and we saw a train of glowing sparks go toward the balloon. But Adjutant T. had fixed his gun. He rose in the basket and fired point blank at the enemy. Alas! he fired only four shells when the breech-block broke, leaving him completely disarmed, while the German, with a new machine-gun, merely unrolled a new belt of 250 cartridges. Finally a French aviator, who had seen the struggle from afar, flew up to the rescue. The aviatik flew away, pursued by the "75's." Brave Adjutant T. was safe and sound, but the basket and envelope were riddled with bullets. This damage was repaired with a few patches.

Such a bold attack is exceptional, but sometimes the aviator uses other tactics to attack the balloon. He chooses a day when great clouds



A Russian observation balloon and its "nurse." An observation balloon after inflation may stay in the air for an entire day without receiving additional gas. When it needs replenishing a smaller balloon, the "nurse," is brought up and the gas it contains is pressed into the larger balloon, the pressing being done by the men, who squeeze the "nurse."

form in a layer above the balloon, two or three thousand meters high. Flying above the clouds, the aviator, seeing his prey through a rift, or judging he is near enough, darts down, releasing his incendiary bombs covered with fish-hooks, which catch in the envelope and are sure to set it afire. Another of these tactics is to take advantage of the clouds that pass between the balloon and the ground, hiding the aeroplane from the eyes of the balloon company, who are unable to train their machine guns upon the enemy.

A Leap Into Space from a Kite Balloon

Experience has taught that the counter-move for this manœuver is not to allow the balloon to rise out of sight above the clouds and, when necessary, to haul it down by the winch every little while. The observer is also provided with a parachute, which he attaches to his back by stout suspenders which pass under his arms and around his waist. If he finds his balloon on fire, or if warned by the telephone from the ground, he jumps out. The parachute, folded in a special sack, opens in less than sixty meters, landing him gently on the ground. This is of quite frequent occurrence. Within three days the life of an observer was saved on two occasions by this means. On the 19th of March, during a violent wind-storm, the rigging broke, and two



The observer descending with the parachute to escape an aeroplane attack.

seconds later the basket started to fall. Instinctively the observer saw his danger, gathered up his papers, jumped into space and descended with his parachute. When his feet touched the

Turning on the gas from gas cylinders to inflate a Kite balloon. Wherever a Kite balloon is established there are brought the gas cylinders on specially constructed trucks. They are then unloaded and placed on a special stand, as shown in the photo, and pipes are connected to each cylinder and to the main pipe which is connected to the rubber tube which leads to the appendix of the Kite balloon.

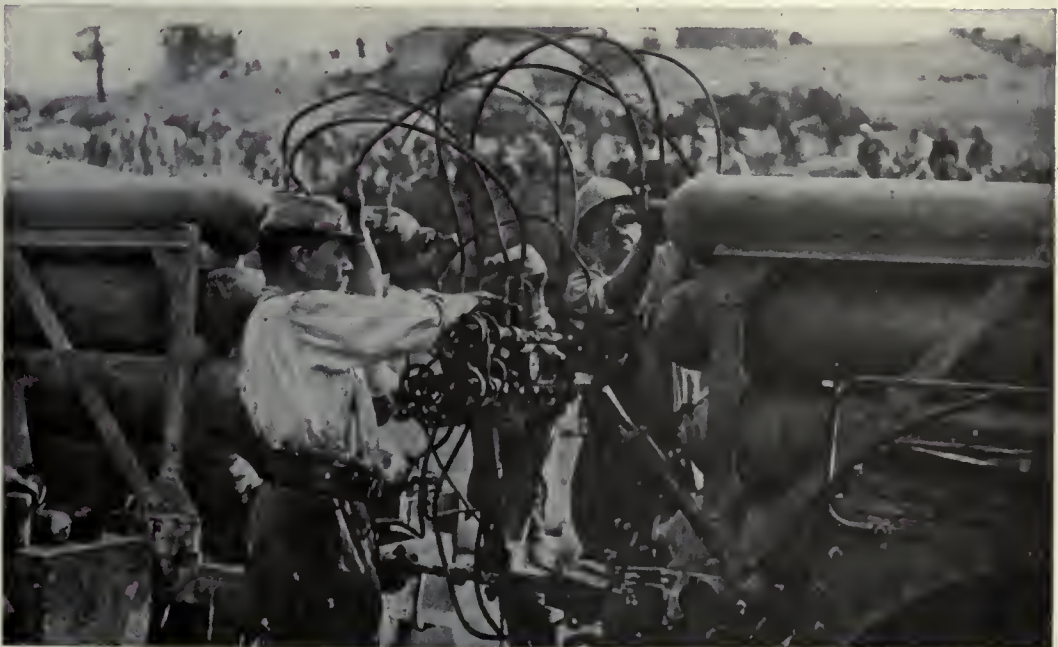



Members of the Canadian Kite Balloon Section patching up a kite balloon on the Somme front.

ground, the eighty square meters of cloth made a sail in the strong wind and he was dragged 1200 meters over the fields, finally bringing up with only a few scratches.

A Curious Manœuver

When the wind rages and the rain falls, the windlass is used to bring the balloon down, but if it breaks, they use a "tiraudes," or snatch block with eight large ropes attached to it. Men pull on this rope, marching straight away, bringing the balloon down to the ground one half as fast as the winch. A serious situation may arise if the windlass is destroyed by shell-fire and the balloon cut away when the wind is blowing toward the enemy's lines. When this happens, they move the automobile winch away, dragging the balloon like a kite. Of course the observer can always descend by opening the valve and allowing the gas to escape.

A Drama at the End of a Cable

Accidents will happen despite all precautions. Last spring there was a tragic day for our bal-

loons when several were torn away by the wind and driven over the enemy's lines. The weather kept the balloons down all day until about 5:30 P. M., when it cleared and the wind fell to a flat calm, the kite tails hanging vertically along the cable. Two officers went up in one of the balloons. They wished to go high enough to observe a battery that had had the cover which concealed it blown away. To lighten the balloon, they left the only parachute in the equipment on the ground. Suddenly the telephone operator called the observer and said, "Heavy clouds are forming in the southwest." Rapidly the sky became overcast and in an instant the balloon, which had been hanging directly overhead, started northeast. The wind rose, and the Captain ordered the windlass to haul down as quickly as possible. Two hundred meters were wound on the drum, and a thousand still remained. The winch puffed and labored, and finally stopped altogether. "Raise the pressure," ordered the Captain. "I have eight kilograms," answered the engineer. The pressure cannot be raised in a moment, and time was flying. The windlass turned slowly, and again it stopped. "Every one on the hauling ropes," came the order, as a last resort. Two hundred meters were hauled in this way, when the men walking away with the rope were blocked by a large farm building and had to halt.

At this moment the engineer signaled that the pressure was at ten, the extreme limit of the gage, and again the winch began to turn. Hopes arose, but the wind arose, too. The rope jumped the groove of the pulley, became jammed, and the winch stopped. "To the hauling ropes again," the Captain cried. Meanwhile there was another drama at the other end of the cable on which hung the life of two men. The "sausage" tugged at its mooring line, like a horse champing his bit. The basket swayed, capsized and swung like a stone in a sling. The telephone was not yet broken. From the bottom of the basket one of the unfortunates shouted, "One more jerk will be our last." The other cried, "It is all over with us." Alas, his presentiment was only too true. The basket tossed in the air. The stabilizing wings of the balloon were torn off. The balloonet ripped

into shreds, diabolically whipping the air. One after another the strands of the cable broke. The balloon, freed from its leash, leaped into the air, the light car swaying below. It was a tragic moment; there was a lull in the midst of the confusion, but the poor men in the basket were perfectly calm. No more jerks terrified them, but what was worse, they were borne in the direction of the enemy's line. We saw objects fall from the car. They were, as we found out later, the maps and secret papers which the brave men had had the presence of mind to think of and throw down before passing over the lines. This drama had taken only thirty-five minutes. The "sausage," which the Germans fired at as it came down low over the trenches, landed, and the French officers were made prisoners.

Memoranda:

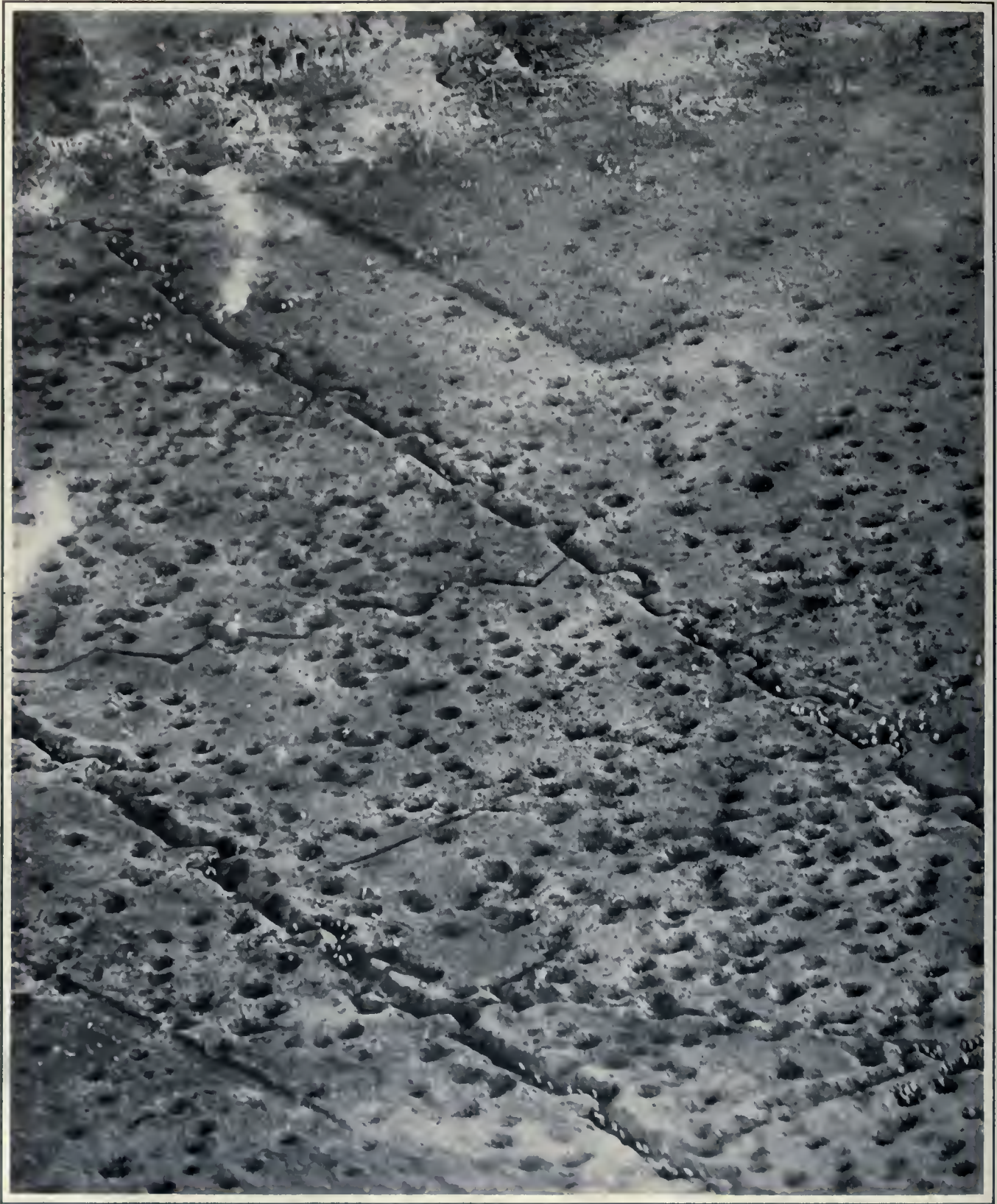

The trenches and shell holes and advancing allied troops photographed by an allied aviator.

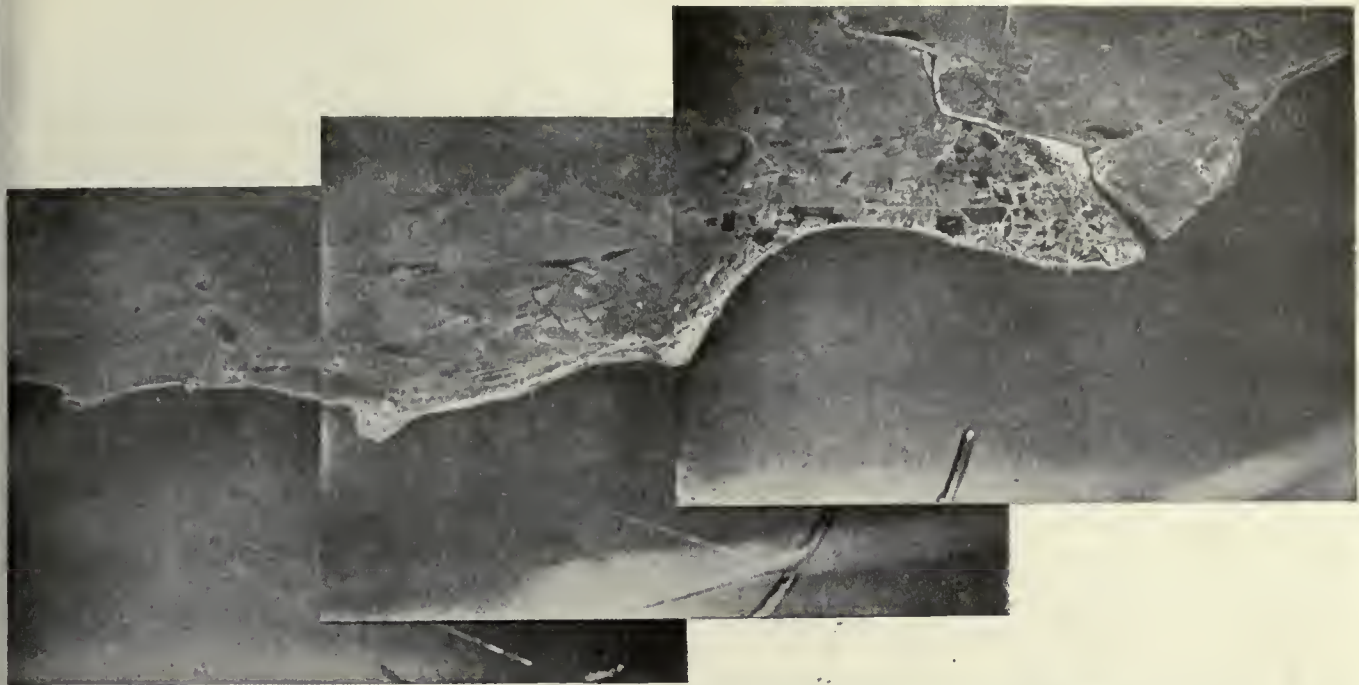

How aero photographs are put together to make a continuous photographic map. These photographs were taken by Allied aviators at the Dardenelles the early part of the war. The city of Tchanak and the estuary of the Kodja Chai; on the right shore is fort Tehimalik and on the left fort Hamidie.

CHAPTER VIII

AERO PHOTOGRAPHY

In the official reports of military and naval operations in the present war daily items can be found reading more or less as follows:

On May 20th the French prepared to rush the impregnable positions on Mount Cornillet and Mount Teton. Photographs taken by their aviators showed an immense system of tunnels which apparently concealed German reserves. A single entrance was located and the operator of a French 15-inch gun ten miles away was told to put a shell in the entrance.

The gun started firing thousand-pound shells, and the infantry was ordered to advance at a certain minute. Two hours before the time set for the advance a half-ton shell planted itself squarely in the mouth of the tunnel, killing half of the men inside, blockading the exit, and wrecking the transverse corridors. The French advanced and took several hundreds of prisoners without suffering any loss.

Thousands of Miles of Photographic Maps

The military and naval authorities of the warring countries have thousands of miles of photographic maps. These are kept up to the minute by the constant stream of aerophotographs brought to headquarters by aviators,

where they are developed, studied, and the minutest changes noted on the map.

The following report gives an idea of how exact a science aerophotography has become, and what its value is in connection with military and naval operations:

Several series of photographic plates, taken by British naval observers after the bombardment of Ostend by the British forces on June 5th, have arrived at the Admiralty in London and afford a remarkable example of the development of photographic observations and record by aeroplane. They show in undeniable fashion that the British bombardment of Ostend on that date was the most successful thing of its kind yet accomplished, insuring that Ostend will be crippled as a useful German base for weeks, if not permanently.

The first series shows the German base before the attack, while a second group shows the effects of the bombardment. In the pictures of the harbor one is immediately struck by a slight change in the appearance of the great lock-gates on which all the activity of the harbor depends. These gates are 100 feet long and 25 feet high, and they seem somehow to have lost a little of their rectilinear character overnight. The magnifying glass reveals some of the reasons for this change. The breaking down of the



One of the large French apparatus for taking photographs from aeroplanes.

locks prevents the retention of water in the basin and the canals which feed it, incapacitating the entire port machinery. Equally effective in crippling the harbor is a hit on the operating machinery, jamming the locks so that ingress and egress is impossible until elaborate repairs are made.

The pictures confirm the statement in the official communiqué that more than half the buildings in the factory section of the town have been either destroyed or badly damaged. It is easy to see that there may have been a heavy loss of life, although the residential section apparently was untouched. Some of the ruined factories necessarily operate night and day and many men are employed at night on the shipping and docks. British shells, dropped from a height of

miles by the high-angle fire of the British monitors, located at a point far below the horizon, frequently fell straight through the roof of a shed or factory, blowing out great sections of the sides and roofs and hurling a shrapnel-like shower of splintered wood, steel and rock into the adjacent buildings.

Twenty Per Cent. of Aeroplanes at the Front Used for Aerial Photography

Every military operation is preceded by an extensive photographic survey of the enemy's position and hundreds of photographs are taken by the aero photographers, until headquarters has obtained all the information necessary to complete the photographic map upon which the operation is to be based. Fully twenty per cent. of the aeroplanes used at the different fronts are employed in taking photographs of the enemy's positions.

For this purpose are usually employed machines having a speed of about eighty miles an hour, and the aerophotographer must go down as low as possible over the enemy's lines, without actually going below the "safety" point, which varies under different circumstances.

When one side has command of the air, and there are plenty of fighting machines about to keep the sky clear of enemy aeroplanes, the task of the aerophotographer is comparatively easy, because he only has to contend with the enemy's anti-aircraft guns. Firing these is not always thought advisable by the enemy, as it gives the location and range of the batteries to the kite balloons and artillery aeroplanes of the other side. Till recently the aerophotographer was sent out in a fairly slow aeroplane, with a number of fighting-machines to protect him. The fighting-machines, flying at a speed of about



A French machine used for photography in 1917.



Side view of one of the Farman aeroplanes used for aerial photography.

120 miles an hour, would fly around in circles looking for enemy machines, while the photographing-machine went about its business of taking photographs. But oftentimes a lonely German aviator, who had taken his position high up in the sky while waiting to dive on Allied aeroplanes, in accordance with the tactics established by Immelmann and Captain Boelke, would spy the slow photographing-machine and dive for it, shooting as it drew near and landing immediately, whether it brought down the photographing-machine or not.

In this case the fighting-machines which escorted the photographing-aeroplane were unable to defend it, because the battle was all over before they could manoeuvre to a position which would permit them to intercept or fight the attacking German aeroplane. As they were flying over German territory, they could not follow the German machine in its flight downward over the German lines, because of the German anti-aircraft batteries.

This method involved sending out from four to six machines to convoy a single photographing-machine, but did not permit as good protection as is afforded by sending a larger photographing-machine equipped with several machine-guns mounted forward and rear. These

permit the gunners of the photographing-machine to defend themselves against attacks from even two or three enemy aeroplanes. With this larger type of machine the effect of an attack does not involve the loss of the aeroplane, the aviator, and the photographer, as in the case of the smaller machine which is unable to defend itself. In the former, if the photographer or one of the gunners is hit, the other two members of the crew can keep up the fight while flying back to their own lines, or until reinforcements arrive. Therefore the tendency is toward the employment of larger and well-armed aeroplanes for aerophotography.

The Aerophotographic Organization of an Army

Since the value of aerophotography became recognized, the armies in the field have had special aerophotographic corps. The size of these corps has been increasing steadily.

As many of the American aviators now being trained, or to be trained, will undoubtedly be employed in photographic work, the following detailed description of the British aerophotographic organization will be of great assistance in giving the student a comprehensive pen-picture of this work.

**Seven Aeroplane Bombs Photographed Soon After Release by the French Aviator
That Released Them on a German Plant**



The above is one of the most remarkable snapshots of an aerial bombardment. It is an enlargement of a photograph taken by a French aviator at a height of over 13,000 feet during a raid on a German munitions plant between Metz and Briey, in the occupied part of Lorraine. The bombs are shown the moment after they were released from the aeroplane, and by reason of the perspective appear as if they would fall in different directions far from the object aimed at. But the aviator has to throw the bombs in such a way as to allow for the fact that he is traveling at a great speed and for what corresponds to the trajectory of a projectile from a cannon. The bombs used for aerial attacks are known as "M" (Michelin) bombs, and are of two kinds, weighing from 20 to 100 pounds. In this case all the bombs were thrown together and succeeded in hitting their object, the German munitions factory below. The district chosen for attack is a great manufacturing region the Germans have turned into a huge war factory. The British and French armies are confining their air raids exclusively to military objects, such as the bombing of the submarine establishments behind the German lines. Although we receive reports of only the more important aerial attacks, these attacks are of daily occurrence, and have caused far more damage than the Germans care to admit. (French Official Photo.)

**Aeroplane Photography That Shows Minutest Details of a
Factory Chimney Being Repaired!**

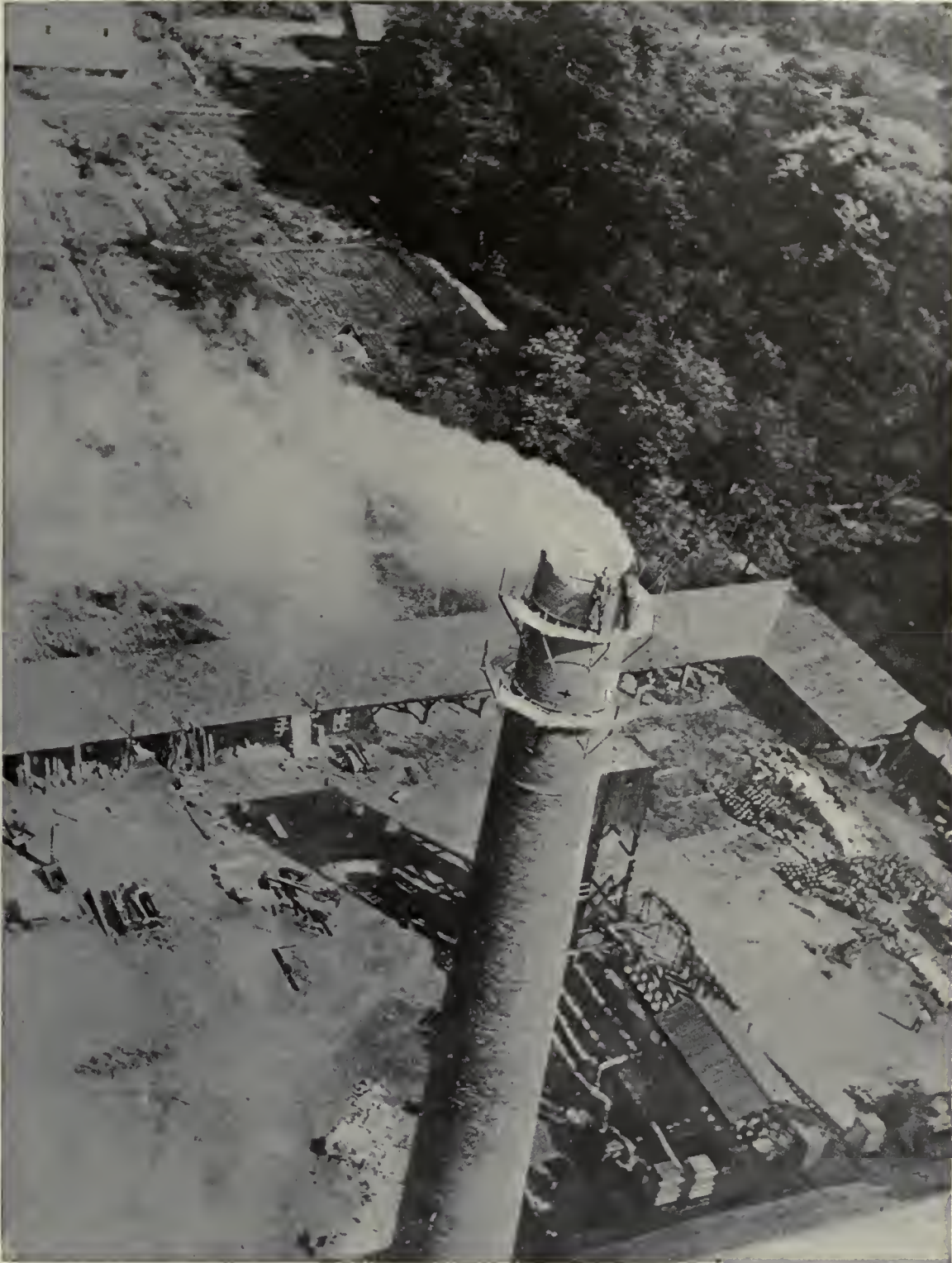

This remarkable photograph taken from a French aeroplane shows how the Allied aviators can fly low and choose their target in bombing German munition plants, provided there are sufficient aeroplanes to fire on and silence anti-aircraft batteries. Also the clearness of the target on an aerial photograph for use by the artillery.



Film-picture taking in mid-air: a photographer and his camera in a kite-balloon.

The prints are kept in wallets in series by squadrons, *e.g.*, all No. 25 squadron prints from 25 w 1 to 25 w 1000 would be kept in this serial order in probate wallets.

Thus it is possible to refer to photographs in every way by date, squadrons, area, and so on.

A Photographic Officer Should be Familiar With the Following Technical Subjects

The necessary accommodation for the work at present demanded from a section.

Apparatus used—function of each item—which essential and which non-essential. Rough and ready substitutes.

Construction and care of cameras. Details of mechanism and weaknesses. Properties of focal plane shutter, and of Anastigmatic lens. Function of color filters, and Panchromatic plates, advantages, and disadvantages. Causes of failure.

Attachment of cameras to machines; advantages of the various systems and the reasons. Vibration; results of investigations in the field.



Going up in a Cacquot balloon to observe artillery firing in France, and taking photos at close range.

How scale varies with height, and focal length of lens.

Detection from prints of bad work; difference between good prints from poor negatives,



The Canadian official kinematographer going aloft in an observation balloon.



A German Scout photographed by a French Scout early in 1915 when aerial fighting was not in practice.

and poor prints from good negatives. Stains, and their cause and cure.

Identification with map—this of the first importance—recognition of roads, trenches, tracks, wire, batteries, etc. Map square system co-ordinates.

System of central registry and filing of photographs.

Possible output of prints in a given time. Any section should, in times of stress, be able to send out for a week without breakdown.

Time necessarily taken by the various processes.

Simple intelligence reading of photographs.

Cameras and Fittings

It is the duty of the non-commissioned officer in charge of the photographic section to see that the camera fitting is properly fixed to the machine and to place the camera in it, adjust slit, clear lens from dust and wind the tension. On no account should cameras be kept in the hangars.

Cameras can be taken from hot to cold, but the reverse causes condensation to form on lens. Care should be taken to avoid this, or the reconnaissance will be a failure.

Loading of Plates

All plates should be loaded in absolute darkness, and the metal sheaths should al-

ways be cleaned from dust and rust before loading.

It is advisable to load magazines as required, and not keep them loaded, as metal dust accumulates and particles of such dust set up chemical action. Cameras should be kept scrupulously free from dust, which is one of the worst enemies. Nothing spoils the appearance of a print so much as innumerable pin holes.

Negative Developing

Discrimination must be shown not to treat the development of all subjects alike. A town requires less exposure than green fields, and must be treated accordingly.

Over-development is the usual fault. In some countries with chalky soils, much detail is lost unless great care be shown in timing the rate of development. A thin negative with plenty of detail printing through the lantern in about six seconds is about the ideal.

Finish of Work

Work is not allowed to stop on any account until all orders are finished.

All dishes, measures, etc., must be thoroughly cleansed before the men are allowed to leave.

Cleanliness in the dark room is essential to efficiency.



A French photography twin motored biplane.



Lines of trenches on the Western front photographed from an aeroplane. Soldiers are shown walking along the trenches.



The war-kite in mid-air.



The observer and photographer in mid-air supported by kites.

A Squadron Photographic Non-Commissioned Officer With His Three Men Should be Familiar With the Following:

Details of mechanism of camera.

Properties of focal plane shutter, and An-astigmatic lenses.

Color filters. Panchromatic plates.

Attachment of cameras to machines. Perfect fitting is essential.

Care of cameras and lenses generally.

How to put in a filter and re-lock the lens.

Simple repairs to cameras.

Jams. How they occur, and how they can be avoided.

Loading of magazines in complete darkness.

Use of special size plate and sheath gage for loaded sheaths to prevent jams.

Formulæ at present in use.

Development of

How to obtain thin, quick-printing negatives full of detail.

Value of "color." Big dishes are preferable to tanks.

Cleanliness.

Washing and drying of negatives; use of spirit; avoidance of spirit-fog due to sunshine and change of temperature.

Use of hydrochloric acid to take out occasional excess of color.

Printing; speed is essential. Hand-shading. Every man should be able to make at least good prints per hour.

Substitutes for apparatus. Gasoline tanks as fixing tanks, etc. The excellence of old doped fabric with which to make big dishes.

Development of prints. One man should be able to develop at least 12 prints at once, in one dish with one hand, and to fix them in another dish with the other hand.

Washing: thoroughness.

Drying; spirit and burning-off processes.

Identification of photographs with maps.

Characteristic natural and artificial features.

Reversed writing for marking negatives.

A sound idea of the shutter slits and exposures to be used. System of catalogue, and filing.

Lantern-plate and positive making both on $3\frac{1}{4}$ by $3\frac{1}{4}$ and by contact.

Science of Aerophotography Still Young

The science of aerophotography is still in its infancy. Up to the present time it may be said that only existing forms of cameras, or modi-

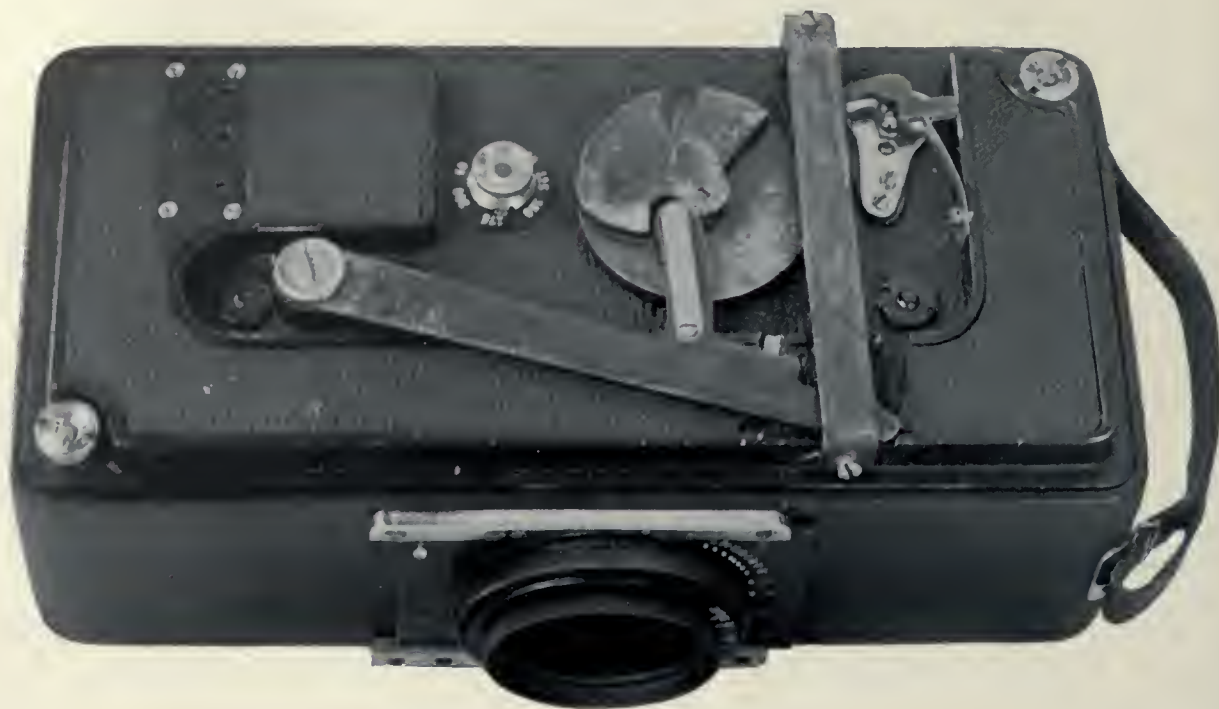

The Herbert & Husgen multiple aeroplane camera.

fied cameras, have been used to take aerophotographs. Little has been done to develop special photographic apparatus to take better photographs from the air at different altitudes in order to show in sharper detail the topography of the country, either straight below or in perspective.

Essentials in Aerophotographs

The essential thing in taking aerophotographs is to bring back a perfect record or map of the



Four types of aeroplane cameras used by the French Air Service. (Official Photo, from the Illustrated London News.)

surface below, with the component objects in their true proportions.

The military commander mainly wants to know:

- (1) The distance between points.
- (2) The location of objects, such as enemy batteries, structures, trenches, camps, roads, ridges, bodies of water, etc.
- (3) The disposition, or traces of movements, or actions of the enemy. If a battery is shown, it is essential to know that it is not a dummy battery.
- (4) The elevation of ridges or depth of depressions where his own forces may hide in advances.
- (5) The nature of the country, whether it is solid ground, marshes, forests, cultivated land, brush, etc.

To take an accurate map of the surface below and eliminate distortions, the axis of the camera must be kept vertical to the ground.

Relative Elevations Hard to Show

Relative elevations cannot be shown in an aerophotograph, except by contrast, when the elevation occurs near bodies of water, or the photograph is taken close to the ground or in perspective.

Whenever airmen bomb places they must bring back photos showing the damage done. As the anti-aircraft guns begin to fire as soon as the bombing plane is detected, the aviator takes the photos of the damage as he climbs to safe altitudes. This photo shows buildings on fire after bombs were dropped.

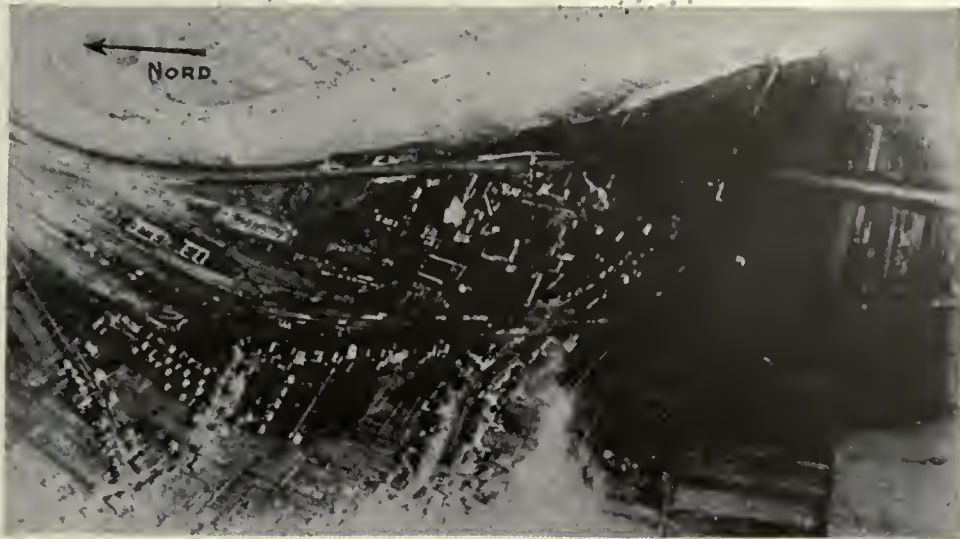

In the last case the image is distorted, although, of course, the information that it conveys regarding elevations is invaluable. But a trained reader of aerophotographs can detect elevations in the prints, as well as the nature of the surface.

The nature of the surface is harder to detect even in ballooning. Messrs. Alan R. Hawley and Augustus Post, during their forty-six-hour balloon trip, which started at St. Louis and terminated in the wilds of Canada, were deceived by the look of the country from a height of 15,000 feet, at which elevation they were traveling. It was in October and the leaves were turning yellow. The contrast of spots where

the leaves were green, extending over miles of country comprised in their perspective, led them to believe they were traveling over cultivated country, when they were, in fact, traveling over unexplored country.

Interpreting Photographs Requires Skill

Interpreting or reading photographs requires skill gained by long experience.

The expert "interpreter" of photographs must be able to gage distances and elevations at a glance, and also tell the nature of the surface.

The camera always flattens the field and destroys perspective, but the trained "interpreter"

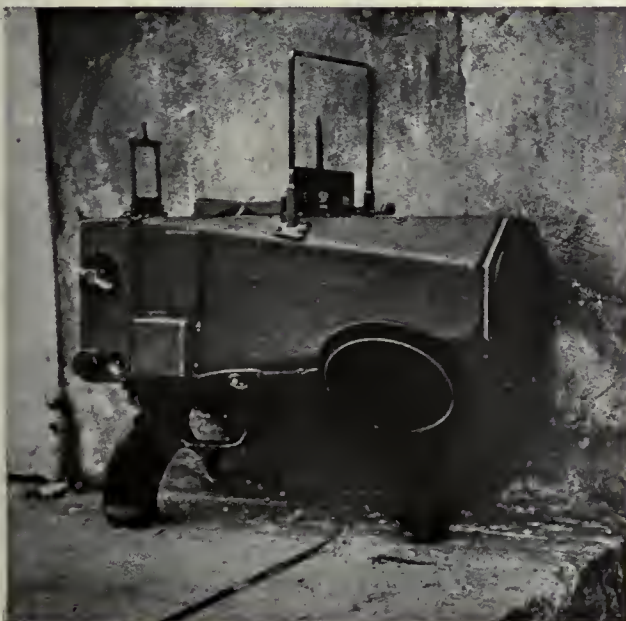

The pistol-camera for German airmen—the right side.



The pistol-camera for German airmen—the left side.



Camera mounted on a British B. E. biplane, Major Campbell in the pilot seat, demonstrating it.
(Photo Bureau of Public Information.)

reaches a point where he is able to tell at a glance the nature of the surface from a photograph.

Problems of Aerophotography

The problems of aerophotography resolve themselves into the one big problem of showing the nature of the things photographed.



The Eastman aeroplane camera.

The important factors in aerophotography are:

(1) *The plate.* Experiments should be conducted to develop special plates, so that luminosity, water-vapor, haze, and smoke can be filtered, and good photographs taken under any condition.

(2) *The method of development.*

(3) *The lens.*

(4) *The mechanical construction of the camera* and the facilities which it may afford for taking photographs in number, with the records of compass direction and altitude as far as possible.

(5) *Skill in taking the photographs.* This has been eliminated to some extent, and it should be further eliminated by evolving rules which anybody can follow in taking aerophotographs. Skill in developing the photographs and printing them is another matter entirely,

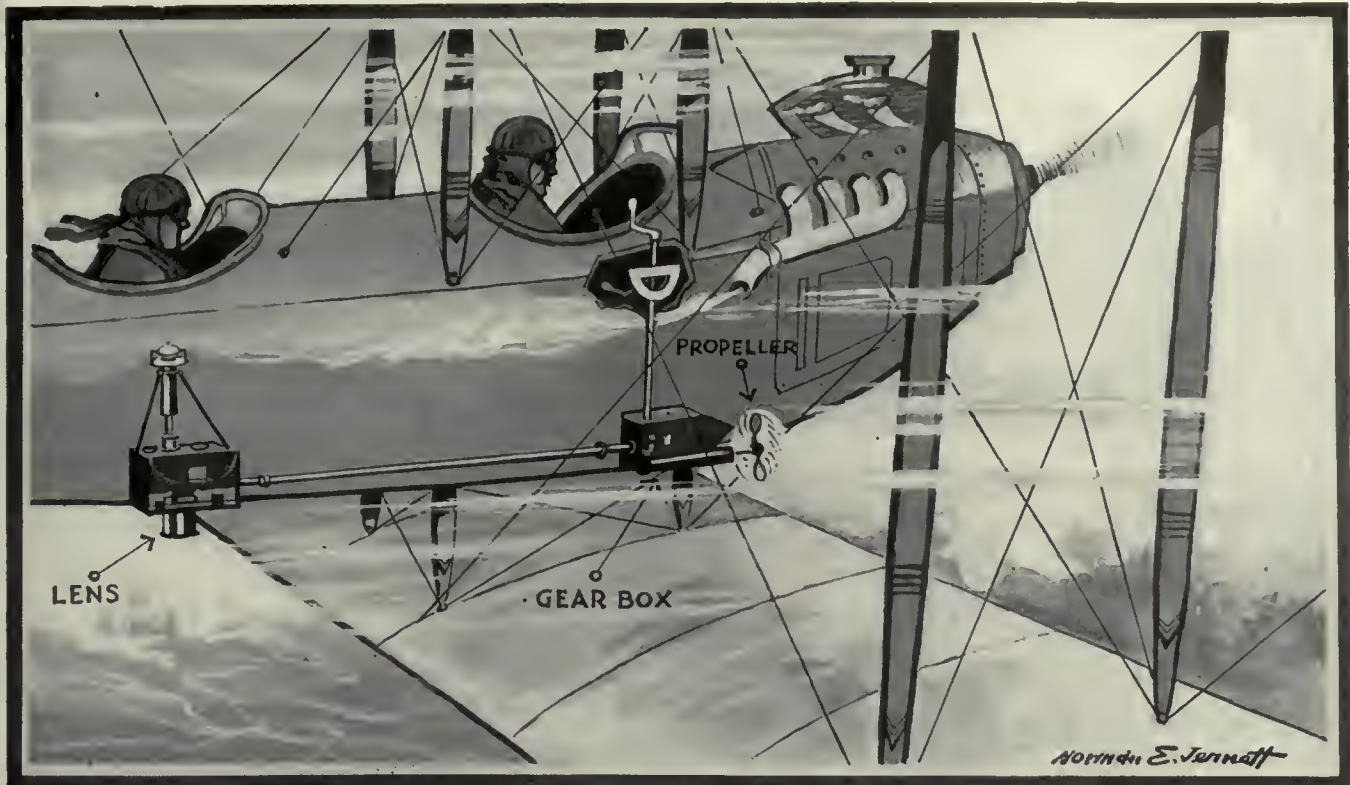

The Fabbri apparatus fitted to a fast scout.

and rules can never be the equivalent of experience.

(6) *Elimination of vibration.* Vibration is one of the worst enemies of aerophotography. It is hard to eliminate it entirely and it causes blurs. These decrease the clearness of the photograph from ten to fifty per cent, although the blurs are not visible to the untrained eye. Vibration is eliminated by mounting the camera on special springs, or by employing a gyroscopic device. Blurs, due to vibration, destroy the photograph so far as getting minute details from it are concerned, although when looking at the photograph one can recognize the larger features of the landscape without difficulty. A good photograph is like a masterpiece by Detaille, so finely and exquisitely worked out that it requires a microscope to appreciate the great wealth of detail the artist has put into his work. On the other hand, a blurred photograph may be compared to a picture by Claude Monet, the great leader of the impressionistic school, in which the salient objects stand out clearly when viewed at a little distance, but become only splashes and daubs of color when closely scrutinized. A blurred pho-

tograph, which may show up with a fair degree of clearness to the naked eye, gives a confused image when placed under a magnifying glass.



Two aeroplane British Royal Flying Corps cameras being returned to headquarters after a flight. (Official Photo.)



An aerophotographer taking pictures in mid-air.

Efforts should be concentrated on developing special plates which will permit the screening of luminosity—caused by violet rays and preventing details from showing in the photograph—and fogs. There are, of course, different types of fogs,—about half a dozen kinds,—and some are more difficult than others to penetrate. On the other hand, certain types of smoke can easily be penetrated.

As a general rule, an aerophotograph is much clearer than a photograph taken on the ground. This is because in photographing from the sky there is only a thin layer of dust to penetrate, whereas in a photograph taken from the ground the distance between the camera and the objective is one continuous layer of dust. Different types of cameras are used to take aerial photographs, some intended to take wide angles and some to get the details in small areas.

The necessity of photographing positions which are well protected by anti-aircraft guns has necessitated the employment of cameras.



British Naval Flying Corps students being instructed in the handling of an aeroplane camera.
(Official Photo.)

Different Types of Cameras

Different types of cameras are used, including automatic cameras, which can take photographs every ten or twenty seconds.

As the United States is to supply many of the cameras to be used in this war, it is of interest to note that several remarkable cameras are being made in this country. The newest of these, a very efficient apparatus, has been developed by the pioneer aerophotographer, Mr. J. F. Haworth, M.E., of Pittsburgh. Although very simple in construction, the camera takes a surprising number of photographs per

minute, and also records the speed of the aeroplane, as far as it can be estimated, compass directions and a record of the altitude at the time the photograph was taken. Mr. Haworth carried out the photo-cartographic work for Mr. Curtis, the artist, who made the remarkable geological reproduction of the Kilauea Volcano, Hawaii, which is now in the Agassiz Geological Museum of Harvard University. It was found necessary in this work to produce aerophotographs with rapidity, fidelity, and correct orientation. A special camera had to be devised for the work. First of all, the camera-

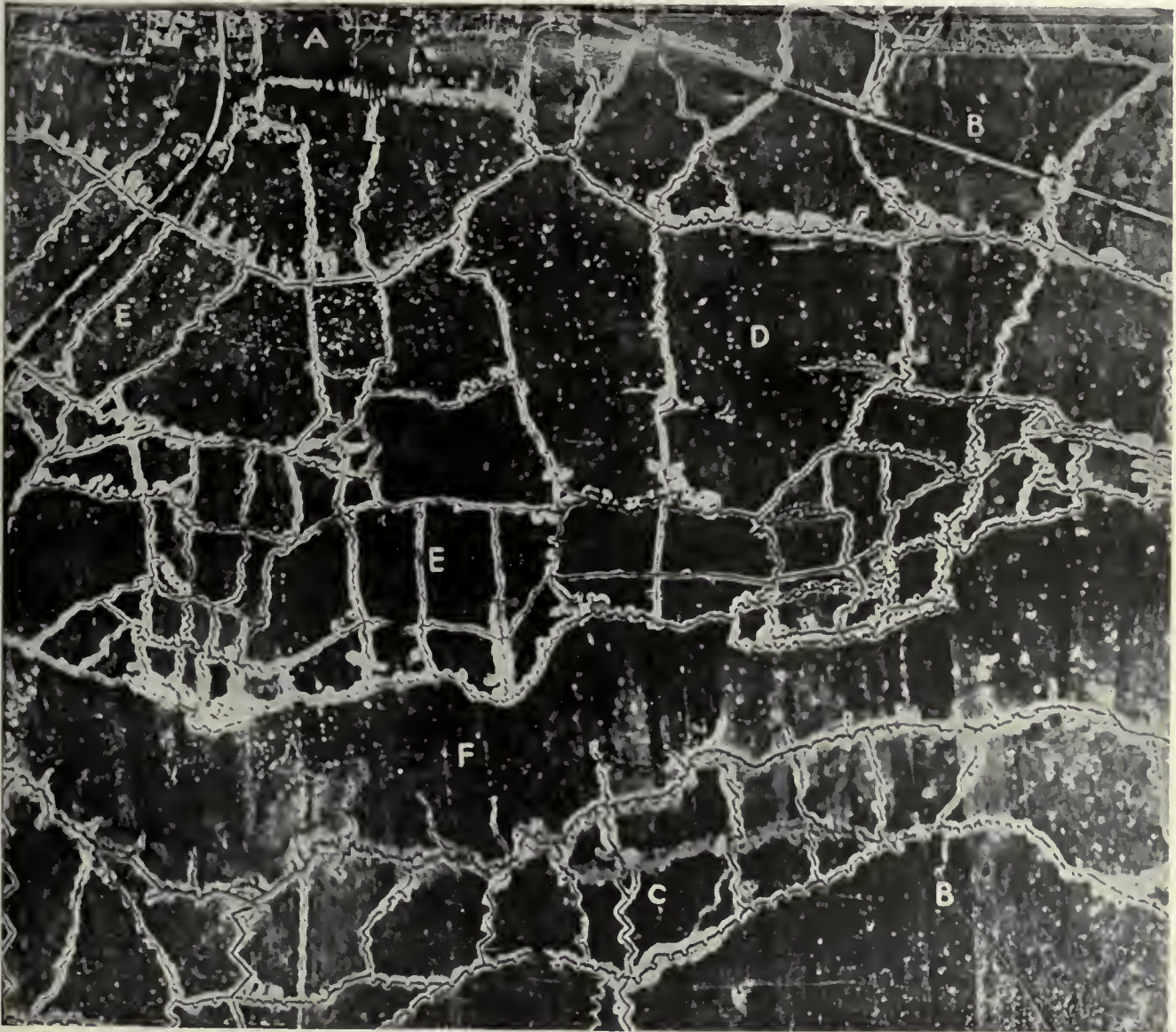

Remarkable photograph of the Champagne trenches taken by a French military observer during a terrific battle. It shows how the trenches are scientifically constructed in zigzag formation, so that if an enemy should capture them, it would be impossible to shoot any distance down them. The earth in the Champagne district is of chalk formation, which outlines the trenches in white. The pockmarks in the picture are where the shells have exploded.

A—Village with unroofed houses in the path of the war. B—Road worn by artillery and supply trains. C—The zigzag construction of the trenches. D—Pockmarks where shells have exploded. E—Connecting trenches between first, second and third lines. F—Ground between the enemy trenches.

maker had to calculate the distance of the geological formations from a known basis. The lava flow of this volcano has an area of six square miles, and it is rich in important geological formations. The work of the camera-maker is more exacting, perhaps, than that of the military map-maker. A camera was devised which works automatically with its axis vertical to the surface of the earth, and has a wide field on either side. It is necessary to take successive pictures and correlate them by successive overlapping. It was found that the magnetic north and south of each picture and the altitude facilitated proper placing at the scale of the formation.

The camera now available for aerophotography remains unchanged, except that the time of day is now reported on the photograph. This is done automatically and the mechanism of the camera can be set to take several pictures a minute. A complete record of the surface of the earth beneath the aeroplane may be procured by merely touching a lever. The camera records the time the aeroplane goes over a given point in the enemy's country, the compass directions, and the speed of the aeroplane as far as it can be estimated.

Two other remarkable cameras suitable for aero-work have been constructed by the Herbert & Huesgen Co. of New York and the Eastman

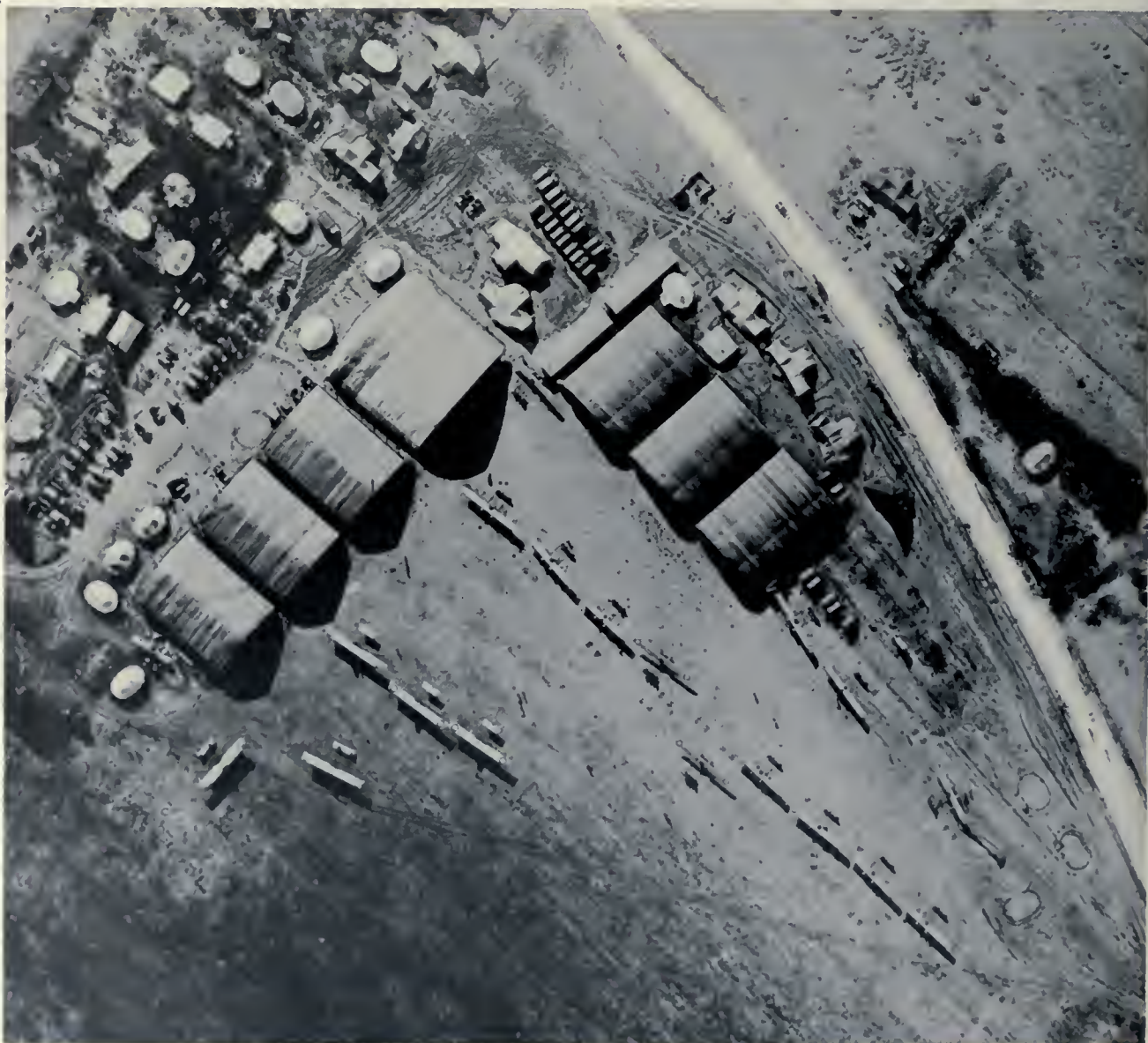

Aero photo of a military aerodrome, "somewhere in France," showing 17 twin-motored Caudron biplanes and about 50 motor transports belonging to the aero squadron. The seven huge hangars can house about 60 aeroplanes.



The Allies' command of the air on the western front, which permits Allies' airmen to map the enemy's trenches. A French airman flew over the enemy's lines and brought back to headquarters in a few minutes this perfect map of the enemy's trenches, with French shells bursting over the trenches.

Kodak Co. The first makes it possible to take 750 pictures with one loading. As a standard size film is used, it may easily be projected on a screen for military purposes.

The action of the camera is automatic. One pull of a flexible cable sets the shutter, makes the exposure, winds up the previous exposure and registers the number of photographs. It is universal in focus. The lens is exactly the same as that used by professional operators of motion picture cameras, being the highest grade astigmat, with a speed of f.4.8. It is easy to operate, and the military aerophotographer can take hundreds of photographs of important positions in quick succession and yet operate a gun to defend himself. This camera

weighs only 6 pounds and is constructed entirely of metal and, therefore, is not easily broken. Altitude photographs may be taken with this camera from a height of 10,000 feet with a lens of special focal length, supplied with the camera. Motion-picture films of standard make are used, which give minute definitions and great capacity in a small space.

Film vs. Plate

On account of its lightness, unbreakability, and simplicity, the film is preferred for aerial work, especially since there are cameras which permit loading for hundreds of exposures. The possibility of turning out films which give as good results as plates is excellent. A great ad-

Possible Troubles in Taking Aero Photographs and Their Remedy

Faults.	Probable Cause.	Remedies.
Plates fogged.	Leakage.	Examine all screws on cone, changer and lens plate. Open slit in blind and place an electric lamp inside the cone and examine for light in the dark room. Take off changer, and fit the magazines with lids open, place a lamp inside the magazines and examine for leakage between magazine and changer. Examine also the magazine lids.
Movement on plates.	Slit too wide. Shutter sticking. Bad fitting on machine.	Examine cord, pulley plate, teeth on "set" wheel and pinion. Examine blind and notice if the slit is true.
Negatives out of focus.	Lens working out of flange. Sheaths not dropping true on changer slide.	Tighten up, re-focus, and fit grub screw. Test with gage. Test with sheath in gage.
Changer jamming.	Changer handle not being pushed forward to end of movement, and not allowing the plate to drop clear of the aperture in changer slide into receiving magazine. Sheaths being inserted in the wrong side of the magazine, thus allowing the open edge to jam in the forward movement.	Take camera off machine, and turn upside down, allowing sheaths to drop back in the magazine. Close lid in this position, and re-fit the sheaths in their proper position in the magazine.
Changer working stiff.	Small chips of glass worked into changer. Changer handle hush working loose.	Take off top half of changer and clean out; oil runners. Take off top half of changer, remove changer slide plate, and tighten screws holding hush on to plate, file off any protruding screw ends on reverse side.
Changer handle not able to finish whole of forward movement.	Pulley bracket slide not working freely. Shutter setting cord too tight.	Take off inspection cover and examine. Release retainer screws and allow handle to finish the forward movement, then pull in cord enough to give a 1/4 turn on pinion.
Changer working easily but not setting shutter.	Cord retainer screws loose. Broken cord.	1. Remove the changer from the camera. 2. Take off "set" indicator corner plate; the pulley on shutter pinion will now be exposed. 3. Thread the cord from the inside of the pulley through the hole on the

Faults.	Probable Cause.	Remedies.
		roller side thereof, and secure by means of a knot. Wrap the cord around the pulley five times, first passing it under and then over the groove. 4. Thread end of cord through eyeletted hole in the corner plate. 5. Replace corner plate and changer. 6. Pull cord, so as to set the shutter. 7. Pass cord around sliding pulley on changer and push up changer slide as far as it will go, and adjust the cord to the cord grip which is attached to the corner plate. 8. To Test.—Release shutter and re-set by means of the changer slide handle. If the shutter does not set, the cord is not tight enough, and must be adjusted by pulling a little further through the grip.
Changer working easily but not setting shutter. <i>Continued.</i>	Broken cord.	N.B.—It is very important to notice that while it is necessary to have a certain amount of tightness on the cord in order that this shutter may set, it is equally important that this tightness should be only just sufficient to set the shutter, as otherwise, when working the changer, the cord itself acts as a stop for the travel of the changer-handle, instead of the handle slotted plates. The result is that the cord will snap with the greatest of ease. If the cord is properly adjusted so that it does not act as a stop to the travel of the changer, the cord will last a long time. Fit additional spring from lever to cone.
Releasing lever not working freely.	Camera being fitted on outside of m/c and having a cord on release lever which is exposed to the wind, induces a resistance which the lever cannot overcome. Setting pin in pulley bracket slide broken.	Release cord from retainer and take off pulley bracket slide and re-fit pin. Test with changer gage and case woodwork.
Sheath not passing through changer.	Changer inlet and outlet being of wood are liable owing to damp to swell.	
Changer jamming at end of forward stroke of handle.	Changer slide plate jamming between top half of changer and the small stop-lips on the end of runners.	Bend the stop-lips, taking care the changer plate has the full movement forward when refitted.
Changer handle jammed at releasing position.	Sheaths fitted in magazine wrong way.	

vantage will be gained by developing an efficient film to replate plates. The demands made upon a military aviator at the front are very exacting. Instructions for operating a camera under these extraordinary conditions are as follows:

Memoranda:



Photo of the remains of a Zeppelin which was brought down on British soil, taken from one of the patrol aeroplanes



A regular daily reconnaissance was conducted between Columbus, N. M., and Colonia Dublan, Mexico, the headquarters of General Pershing's punitive expedition and other points by the first aero squadron during the Mexican trouble.

CHAPTER IX

RECONNAISSANCE AND CONTACT PATROL WORK BY AEROPLANE

Wellington said: "Victory belongs to the commander who makes the best guess as to what is happening on the other side of the hill," and winning battles has always depended mainly on quickly obtaining accurate information concerning the enemy.

Until the advent of aircraft, military operations depended largely on skilful guessing. This guessing was made necessary by the fact that scouts, whether mounted or on foot, could only observe the movements of a fraction of the enemy's forces, and the length of time required for scouts to report their observation was sufficient to permit the movement of army corps in an entirely different direction than that reported.

Aircraft, by permitting a scout to observe the enemy from a height where the composition and disposition of military forces can easily and quickly be estimated, have removed the necessity of guessing; and by making it possible for air scouts to transmit with a sixty to one hundred miles per hour speed the movements of an army which can travel at a rate of only fifteen to twenty miles per day, they have removed the elements of surprise.

Balloons were used for observation as early as 1794. At the battle of Fleurus, June 26, 1794, the French employed captive balloons, and thereby gained a decided advantage over the Austrians. Balloons were used in practically every war thereafter. During the Franco-German War of 1870-71, sixty-six balloons were sent up by the French from besieged Paris between September 23, 1870, and January 28, 1871.

Five Types of Reconnaissance

Reconnaissance consists in gathering information from actual observation. The air scout must report facts and may draw conclusions, but must not report conclusions instead of facts.

There are five types of reconnaissance, as follows:

(1) *Distant reconnaissance*, which is essentially an examination of the enemy's country for about 100 miles, made for the general staff for strategical purposes. This is **Line Reconnaissance** and deals more with the enemy's general location and apparent purpose.

(2) *Close Reconnaissance*, which is more

minute in detail and extends about 30 miles into the enemy's territory. It is more tactical and is intended for the use of the local staff. This is area reconnaissance and deals with the details of the enemy's position and defenses.

(3) *Local or artillery reconnaissance*, which is a minute examination of the trenches and defenses. It is seldom more than 8 or 10 miles in extent.

(4) *Special reconnaissance*, which includes observations for artillery spotting, locating new targets, and other special purposes.

(5) *Contact patrol reconnaissance*, which aims:

(a) To keep headquarters of formations informed as to the progress of their troops during an attack.

(b) To report on the positions of the enemy opposing the advance, the movements of his immediate reserves, and the state of his defenses.

(c) To transmit messages from the troops engaged to the headquarters of their formation.

Procedure in Issuing Orders for Reconnaissance

The following is the normal procedure in issuing orders for reconnaissance:

Orders are issued by the General Staff to the wing commander, who in turn issues orders to the squadron commander, who in turn may issue them to the flight commander.

The orders by the general staff usually explain the general situation and so much of the commander's intention as it may be necessary for observers to know in order that they may understand the objects of the reconnaissance.

The information which the commander requires is definitely stated, and the best results are obtained if the information is asked for in question form.

The orders of the wing commander and other officers usually include:

(a) Information as to the enemy and of our own advanced troops.

(b) The object of the reconnaissance.

(c) Route to be followed if general information is required. (If certain definite information is required, the route should not be given.)

(d) Special points to be watched for.

(e) Time of starting if necessary.

(f) Method of reporting and where to send messages.

(g) Procedure to be adopted in case of breakdown.

(h) What other aircraft are reconnoitring



Balloons were the first type of aircraft to be used for observation. An early artist's interpretation of the employment of captive balloons by the French at the Battle of Fleurus, June 26, 1794. Being thus supplied with "aerial eyes" the French had the advantage over the Austrian armies.



The change forced by aerial observers. This shows a heavy French gun in 1914-15. It was not protected from the aerial eyes.

the same objective or on the flanks of the route detailed.

(i) Number and type of fighting aeroplanes assigned to guard and protect the observer, if any are so assigned.

All orders and instructions should be in writing, except in very special circumstances. They must be given as early as possible in order to allow the pilots time to study their course, plot compass bearings, etc.

Squadron and detached flight commanders keep a record of the general situation, so as to enable them to give pilots any information they may require before starting on a reconnaissance. The best method of keeping this record is by means of maps marked with colored flags.

Full information as to the general situation should be given to the pilots and observers, and they should study the map kept up by the squadron commander in order that, in the event of their discovering some unexpected information, they may be able to decide whether it is of such importance as to justify them giving up their original mission and returning at once. As a general rule, however, when an aircraft is given a definite route to follow or a definite objective to discover, it must complete its mission.

General information of importance regarding procedure, signaling map used by observers, etc., can be found in the chapters on "Directing Artillery Fire" and "Areas Photography." Detailed information regarding scientific instru-

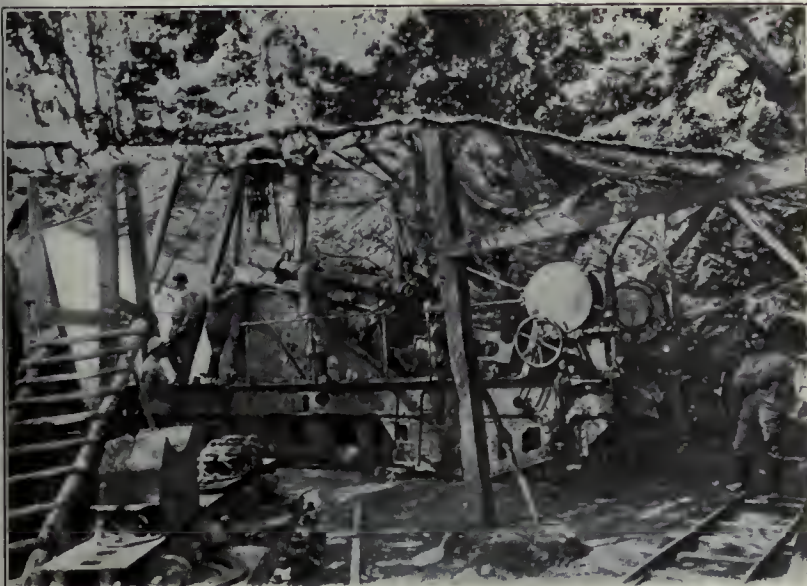

This shows a heavy French gun in 1917, protected from the aerial eyes by a cover of cloth, branches of trees, and other devices that are part of the art of camouflage.



A dummy gun half hidden by trees to mislead the enemy aerial observers.

ments can be found in the "Textbook of Naval Aeronautics," also published by the Century Co., N. Y.

How Reconnaissance Aeroplanes Are Guarded and Protected

The protection afforded the pilots and observer is naturally of great importance. The danger to the reconnaissance machines comes from: (1) Attacks by enemy fighting aeroplanes, (2) Anti-aircraft guns. Against the latter aviators can only protect themselves by gaining information of their location whenever possible from other aviators, and by manœuvring their aeroplanes to dodge shots. Against the former there are two methods of protection: (1) By using larger and more powerful aeroplanes, capable of carrying two or three men and from two to four guns, thereby permitting each aeroplane to defend itself; (2) By sending with the reconnaissance patrol a guard of fighting machines to protect them from attacks.

The former is becoming more and more popular, because it makes every aeroplane self-protecting and eliminates the possibility of reconnaissance aeroplanes being brought down by a lonely enemy machine which can dive down on a helpless reconnaissance machine, shoot the pilot, and land before the protecting machines can act.

As the fight takes place over the enemy's lines, the fighting machines cannot follow the enemy machines in their downward flight without exposing themselves to the fire of the anti-aircraft guns. Three men in a machine equipped with dual controls and several guns can withstand the attack of any machine or of several machines, and one of the three is usually able to fly the machine back to his line, whereas in a single or two-passenger machine the loss of one man often leads to the loss of the other man and the machine.

The first duty of the fighting reconnaissance machines is to gain information and get back with it. They do not go out with the intent to fight, but must be capable of doing so, since fighting is often necessary to enable them to obtain the required information. With two-seaters, the pilot operates the machine and the observer carries out the reconnaissance, and both operate the guns if necessary. In three-seaters the pilot operates the machine, the observer carries out the reconnaissance, and the third man watches for enemy machines. It is best for all three to know how to pilot the machine and operate the guns.

Reconnaissance machines are seldom called upon to act alone, but fly in formation, one or more machines carrying out the reconnaissance, while the remainder act as escort, on the same

principle as an escort on the ground. That is to say, they do not seek an engagement, but fight if necessary, to enable the reconnaissance machines to do their work. See chapter on "Fighting Planes and Aircraft Guns."

Protecting Reconnaissance Machines

In protecting reconnaissance machines from attacks, important use may be made of the directions which have been supplied to the personnel of reconnaissance machines of different countries. These directions have been found on captured flight commanders or pilots, and should therefore be carefully examined by students.

In reconnaissance, the whole object is to protect the reconnaissance machine or machines, and enable them to complete their work. Opposition will usually take one of two forms. The enemy's scouts may employ guerilla tactics, hanging on the flanks and rear of the formation, ready to cut off stragglers, or attacking from several directions simultaneously, or else the formation may be attacked by a hostile formation. A suitable type of two-seater fighting reconnaissance machine will often be able to

deal with either class of opposition without assistance. The machines must fly in close formation, keep off enemy scouts which employ guerilla tactics by long-range fire, and be ready to attack a hostile formation, if the enemy's opposition takes that form.

Reconnaissance formations, like fighting formations, can be organized in groups, each with its sub-leader, but as the object is to secure the safety of the reconnaissance machine, the whole formation must keep together and act as one.

If scouts are used in combination with two-seater machines on a reconnaissance, it is usually preferable to keep the two types of machines as distinct formations, each under a separate leader. The two-seaters act as described, and the scouts fly above them in such a position as to obtain the best view of them and the greatest freedom of manœuver in any direction. Their rôle is:

- (1) To break up an opposing formation.
- (2) To prevent the concentration of superior force on any part of the reconnaissance formation.
- (3) To assist any machine which loses formation through engine or any other trouble.



A fake battery planted to deceive the aerial observer.



Gotha bombing aeroplane brought down in Belgium while returning from a raid on England.

Navigation Rules for Reconnaissance

The height at which aircraft will fly during reconnaissance is governed by the state of the atmosphere and the consequent ease of observation. The duty of gaining information must be the primary consideration, and aircraft personnel must always be prepared to expose themselves to hostile fire if they cannot otherwise carry out efficient observation.

The difficulty of replacing trained personnel and aeronautical material must, however, always be borne in mind.



Shells of the big guns hidden from the aerial observer's eyes.

Once obtained, information must be delivered at headquarters as safely and rapidly as possible. Consequently, aircraft returning from reconnaissance should fly at such a height as to render them absolutely immune from fire from the ground.

The chances of being hit from the ground will be diminished by following an uneven course both in direction and elevation. Advantage may also be taken of cloud for concealment.

The action to be taken against hostile aircraft will vary according to the mission which the pilot has been given.

Should he have been despatched to clear up some important point, or should he be returning with valuable information, he must be careful to concentrate his energies on avoiding hostile aircraft.

If, on the other hand, having seen nothing, he should meet a hostile aircraft over or near a place where it is obvious that it must have gained valuable information, he must attack it.

It must be borne in mind that the side whose aircraft show the greater determination to fight on every opportunity will rapidly gain a moral ascendancy which will largely contribute to obtaining the command of the air.

Pilots and Observers

In order that good results may be obtained from aerial reconnaissance, the same pilot and observer should work together as far as possible. Mutual confidence is of the utmost importance.

It has been found inadvisable to lay down any

rules as to the respective duties of pilots and observers. These must depend largely upon the personality and air experience of the individuals. On receipt of orders, the pilot and observer should consult together with the aid of a map as to the best manner of fulfilling their task and the route to be followed.

Compass bearings, distances, and times must be worked out, and, if necessary, tabulated and fixed to the machine, so as to be clearly visible during flight. Allowance must be made for the probable drift due to the wind at the height at which the aeroplane will fly.

The pilot is responsible that his machine, if in flying order, is ready to go up whenever required. Before starting, he must test his engine, verify the quantity of oil and petrol in his tanks, and make a final inspection of the machine with his mechanics.

He marks the route on his map and places it in readiness.

The observer also marks his map, and in certain cases, when a detailed reconnaissance is required, makes an enlargement of it and duplicates it with the aid of carbon paper. He prepares his apparatus, notebook or writing block, pencils, weighted message bags, watch, field-glasses and, in some cases, a camera.

No person going up in an aircraft should carry written matter or maps which, in the event of an accident, would be found on him and give information to the enemy.

The responsibility of finding the way must be shared by the pilot and the observer; the actual method of navigation adopted depends on the nature of the country, the state of the weather, and the type of aeroplane used.

The pilot will conform to the direction of the observer as regards moving slightly to right or left, so as to gain a clearer view of a road, circling round so as to examine a place more thoroughly, or coming lower down to get a clearer view.

The pilot should assist in observation by looking out on the opposite side to the observer.

Observers must be constantly on the look out for information both on the way out or returning from their reconnaissance; and, though they may have accomplished the tasks specifically allotted



To deceive the aerial enemy's observers the art of camouflage is applied to men as well as machines. The crew of a French anti-aircraft gun dressed with a view to invisibility.

to them, they must not consider their duty finished.

In addition to using a speaking tube, a simple code of signals should be arranged so that the observer can communicate his wishes to the pilot without the latter having to switch off or throttle down his engine.

In the case of a forced landing inside the enemy's lines, when it is evident that the machine must be captured, the pilot is responsible for taking such steps as will render it useless to the enemy; setting fire to it will generally be the most effective method.

The pilot will assist the observer in making out his report. All reports will be signed by the observer.

Messages should be written out fully in the recognized manner, headings being as far as possible filled in before leaving the ground. It must be remembered that the omission of any of the usual headings will reduce the value of a report or may even render it useless.

The positions of troops on the ground, especially when they are scattered, can often be most easily explained by showing them on a carbon tracing or enlargement of the map. A rough diagram will frequently be of great value in



Directing a movement of troops by aeroplane.

elucidating the exact meaning of a written message.

Facts only are to be reported; it is the duty of the staff to which the report is sent to make the deductions. For instance, the positions of the head and tail of a column at given times should be stated and not merely its deduced strength.

An observer will always report if he is in any

doubt regarding the reliability of his observations.

In cases when an aircraft has been out for some hours and seen a number of small details, it is advisable to add the general impression formed by the observer as a result of what he has seen, but it must be made quite clear that this is merely an opinion and not necessarily a fact.

It is of great importance that reports from aerial observers should reach their destination as soon as possible. Much of the value of aerial reconnaissance will be lost if the information so quickly gained is delayed in transmission to headquarters.

Aircraft Report Diary

An aircraft report diary should be kept in each squadron or detached flight.

A summary of the information collected



The Sopwith tractor biplane, widely used in the war zone.



A Russian air scout operating under difficult conditions.

should be made out daily and sent to the headquarters concerned, to prevent the possibility of any message having been overlooked or having gone astray without the knowledge of those concerned.

Contact Patrol (Aeroplanes De Liason)

The contact patrol, which came in the year 1916, is one of the latest developments in military science. Established at first as a convenience, it is now a distinct service of extraordinary importance, and binds together the aerial and land forces.

As a writer pointed out in *Aerial Age Weekly* recently, Contact Patrol, which is one of the chief *raisons d'être* of the aeroplane, is a special tactical reconnaissance carried out during the progress of an attack. It establishes a liaison between the front line infantry and their battalion headquarters, corps, or division headquarters in the rear. The aeroplane is the most valuable means of connection, and accomplishes the following objects:

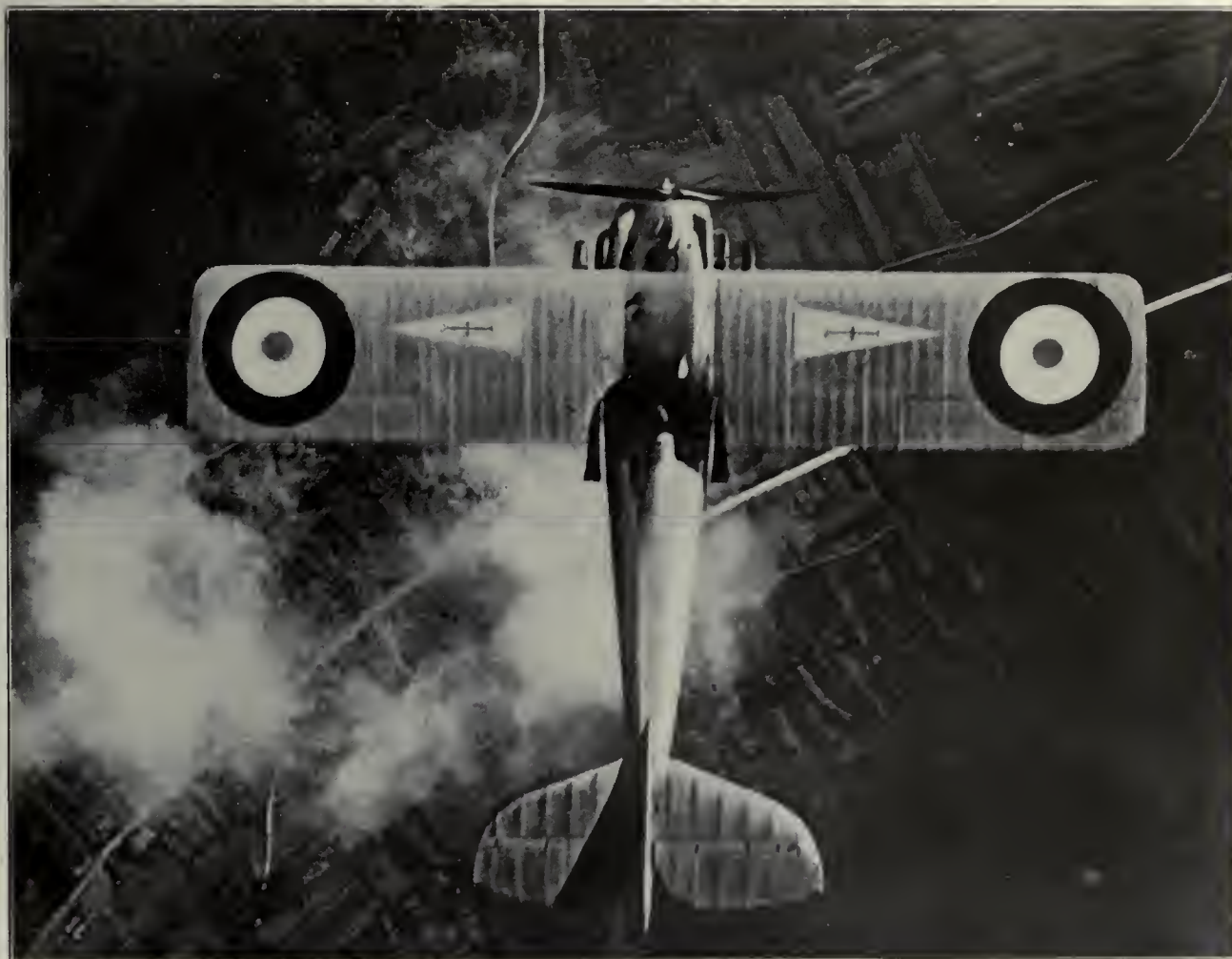

Remarkable photo of a French Spad Chaser plane, taken from above, under great difficulties.

© Underwood & Underwood



One of the Breguet bombing type biplanes used by the French, which are most remarkable climbers, though they are limited in the load they can carry. Unfortunately the Germans have brought down several of this type and will be able to copy it.
(French Official Photo.)



A Farman reconnaissance biplane passing another reconnaissance machine.

1. Keeps higher command informed of own troops' movements.
2. Keeps higher command informed of enemy troop movements.
3. Carries messages from battalion headquarters to corps and division headquarters.
4. Reports the state of enemy trenches during an attack, and also reports any new enemy trenches.

There are four methods of signaling from the ground to an aeroplane engaged in contact patrol. They are:

1. Ground strips. This method consists in white strips of cloth which are placed on the ground in various shapes according to prearranged code. Thus, a ground strip in the shape of a "T" might mean "Need Ammunition," or some similar message.
2. Signal Lamps. These are colored lamps with a special slide which permits light to appear in flashes, long and short, and the messages are sent according to the Morse Code, or some other prearranged code.
3. The Shutter. The shutter is a device very similar to the ordinary window blind, with one side of each shutter painted white and the other side black. It is operated by a cord, and the code used is generally the Morse International.
4. Flares. These, as the name suggests, are simply oil-soaked cloths which are lighted by the front line troops to show their position during the attack.

On sunny days the method most used is the panel, but on dull days the lamp is used. Generally an infantry battalion has either the lamp or the panel (Shutter), sometimes both. The battalion headquarters always has both. All messages are sent from battalion headquarters.

The following are the methods used by the aeroplane to communicate with headquarters: 1. Wireless. 2. Signaling Lamp. 3. Klaxon Horn. 4. Skeleton maps, and messages dropped in weighted message bags. In some brigades, by Very's lights and smoke bombs. In the Very's light method a red and green flare are used, and the succession in which they are fired indicates the message. Wireless is very rarely used in contact patrol work, and is never used to refer to the position of our own troops, as the code might be intercepted by the enemy very easily.

As our own barrage fire is regulated by the aeroplanes on contact patrol, the pilot of the aeroplane must be absolutely certain that the troops signaling they are the first line *are* the first line, as a mistake would place them directly under their own barrage from the rear. Thus in very doubtful cases the aeroplane flies so low that the pilot recognizes the uniforms of our own troops. This, of course, makes the



A "protecting" Nieuport fighting biplane photographed by the observer of a reconnaissance machine.



A two seater Morane-Laulnier contact patrol machine.

work very dangerous. The procedure of contact patrol work during an attack is as follows:

The hour for the attack is known as the "Zero Hour," and all watches and time pieces are carefully set to coincide to the second. Exactly at the Zero Hour the aeroplane must arrive over the front line trenches, in such a position to be over, or under the expected barrage, generally just over it, at a height of 1500 to 2500 feet. The pilot watches the attack until the infantry

reaches its first objective, then signals "Where are you?" by one of the methods described above. The infantry, in response, lights a flare to show their position, and the pilot traces it on a skeleton map, and flies directly back to headquarters. Arriving at this position, he places the map in a weighted message bag, together with any other message he wishes to send, and, coming down to an altitude of about 200 feet, drops the bag. If the ground does not acknowl-



An Allied Zeppelin chaser which carries a machine gun mounted in front of the car, and attached to the frame work are a series of rockets, and below the lower wings a battery of searchlights. Note the rockets for setting Zeppelins on fire.



A squadron of Nieuport and Spads often used for special contact patrol work.

edge the message in two minutes, he drops another, and keeps this up until his message is received and acknowledged.

An example of the great courage often displayed in this branch of work was shown during an attack on Dead Man's Hill by the French

Infantry. As is well known, this hill has passed back and forth many times, and some of the fiercest fighting of the war has taken place on its slopes. During this particular attack the pilot of the aeroplane engaged on contact patrol wished to make no mistake, so, descending



French pursuit machine being prepared for a flight over the enemy's lines. (French official photo.)

under his own barrage, to a height of about 100 feet, he flew directly over the heads of his own troop, and literally *climbed the hill with them!*

Contact patrol is thought to be the most dangerous of all the various usages of the aeroplane at the front, and requires a man not only of unquestioned courage, but of great judgment. It is the connecting link between the man in the trench and the man directing the attack, and as such must at all times give accurate information, as one mistake may mean the loss of thousands of lives. It is a work without the glory

of the aerial fighter in his scout machine, miles above the earth, but is vitally important to the success of an attack. In an attack, in addition to doing his work, the pilot has five forces to contend with. They are: His own barrage, the enemy's barrage, anti-aircraft guns, enemy machine guns, and enemy aeroplanes. Thus it can be seen that a pilot who flies up and down the lines in a straight line invites destruction. So the pilot must know the trajectory of the heavy guns being used in the barrage, so as to keep above or below it, he must never fly in straight lines, or continue always at the same speed.

Memoranda:



A patrolling French aeroplane signaling with searchlight above darkened Paris. This remarkable photograph was taken from the Church St. Gervais looking toward Notre Dame (on the right) and the Pantheon (on the left).

CHAPTER X

NIGHT FLYING

Since practically all offensive aeronautic work is now done under cover of darkness night flying is one of the essential things an aviator must learn.

Zeppelin Raids Forced Aeroplane Night Flying

The night Zeppelin raids forced aeroplane night flying on a large scale. The Allies were forced to establish night aeroplane patrols by public opinion, which seemed to take for granted that a few aeroplanes in the sky would be able to prevent Zeppelins from carrying out their work of destruction. Public demand had to be met, notwithstanding the fact that no one could say just how the aviators were to go up at night, whether they could see other aircraft traveling in the dark sky, how they could maintain their machines on an even keel, how they were to return to their starting-place and land against the wind, etc.

Long-Distance Bombing Night Raids

Long-distance bombing raids are conducted entirely at night. During the day the anti-aircraft guns and enemy aeroplanes combine in

preventing successful results. At night neither the anti-aircraft guns nor the aeroplanes are effective. With few exceptions, therefore, raids are conducted at night, unless there are trains loaded with troops or supplies to be destroyed, or something of a pressing nature to be bombed.

Aeroplanes Cannot Be Seen One Hundred Feet Away

At night aeroplanes cannot be seen one hundred feet away, and it is difficult for the searchlights to "pick them up." Dirigibles can be picked up with comparative ease. The invisibility of aeroplanes at night is illustrated by an experience at Salonika. An Allied aerodrome started out one night to bomb the Turkish-German positions. On arriving at a point above the German lines the bombing party was surprised to see the Germans light up their aerodrome. They took advantage of the opportunity and dropped their bombs on the hangars and other buildings. When they returned to their own lines they found that the Germans had meanwhile bombed the Allies' aerodromes. Both forces had planned bombing raids at the same time to surprise the other side. The bombing squadrons passed each



A Zeppelin over London at night.

other on the way, but without observing one another. In each case the officers in charge of the aerodromes, upon hearing the noise of aeroplane motors, thought it was the noise of their own aircraft returning and lit up their aerodrome to enable them to land.

The Operation of Aeroplanes by Night

While the navigation of airships by night is a comparatively simple matter, such is not the case with the aeroplane, which cannot stop in mid-air for the purpose of inspecting the ground beneath. And, whereas an aeroplane lands with a velocity of seldom less than forty miles per hour, it is imperative, if aeroplanes are required to fly by night, to provide adequate landing and navigating facilities.

First, the aviator must know his relative posi-

tion to the ground. For this purpose the machine must be fitted with an altimeter, for indicating the height, an inclinometer for indicating the aeroplane's inclination, and finally, position lights showing the transverse position of the wings. The latter requirement is attained by small electric bulbs (colored blue so as not to blind the pilot nor reveal his presence to the enemy) which are fixed on both wing-tips; the current is furnished by a storage battery, which is also used for lighting the blue lamps which permit reading the navigating instruments.

The same battery may, furthermore, be used for working a small searchlight, with the help of which the pilot might hope to effect a landing if forced down by engine trouble. The use of searchlights, however, has not been general on aeroplanes. Since it might reveal the avia-



French aviator about to start on "Zeppelin Duty" at night, the searchlight being temporarily turned on the machine.

tor's presence to the enemy, it is now used extensively for landings.

The second and principal requirement for night flying—assuming the engine to be of a reliable kind—consists in providing adequately lighted landing-stations.

Lighting the Aerodromes

The principle governing the lighting of aerodromes for night landing consists in suppressing all light that might blind the aviator, and only using such as will make the ground appear clear enough for recognition. Numerous systems of lighting aerodromes have been tried, and new methods are being experimented with continually. The first method employed was the use of petrol flares, which are nothing more than buckets of petrol set on fire. This method is still in use, but it is essentially a makeshift, being both dangerous and expensive.

The use of electric lights affords the greatest efficiency, at the same time making it possible to turn all the lights on or off simultaneously. The lights, whether flares or electric lights, are

placed so that when lit they form from the aviator's position a wide arrow, which points into the wind. The aviator lands in the wide part of the arrow, and since the aeroplane proceeds toward the point, he flies into the wind.

In a recent article in "London Aeronautics," a writer gives interesting information on night flying, with special regard to conditions obtaining in England and in France, as follows:

"The conditions of night flying in England and in France are vastly different: in many instances pilots fresh from England have had no previous experience in it, while others who have flown a lot are not up to the same flying standard as those who are initiated out there. Anyway, they all require a lot of practice from a military viewpoint.

"Individual opinions often differ as to the merits of particular machines, and it is not often that one gets such a unanimity of view as is expressed in favor of a certain type in regard to its nocturnal qualities. It makes an excellent night flier and—more important—night lander;



Powerful searchlight for illuminating hangars.



Searchlight illuminating landing ground.



French aeroplane for night operations showing the searchlight on the machine and small lights under the bottom wing. General Pershing is visiting French aviation camp.

pilots with very little, or sometimes no experience in this art of flying invariably make good landings on these machines. Naturally, pilots with insufficient experience are not permitted to take up observers to fill the passenger's seat, and consequently ballast is required to give the machine longitudinal stability. This type, being perhaps the most successfully designated of the R. A. F. productions, is extremely tail heavy without its full complement, and even with 100 lbs., is still light; pilots will find that 135 lbs. weight will give the best results and will eradicate any jerky tendency should the engine suffer from 'variable pull'—in fact, the machine has been safely flown 'hands off.'

"While on the subject of landing, it is interesting to note that the French have an excellent landing system, very similar to our own, which has been extensively used during the recent and present Verdun operations. Barring unfortunate contingencies, French machines are not permitted to land until they get the signal 'All clear' from below. When a French pilot arrives over what he thinks is his own aerodrome, he circles around, sending his own special letter

in Morse by searchlight; this should be answered by one of the ground projectors, and a machine should never land until the call has been answered, the main idea being to prevent machines landing on hostile aerodromes or even on those of neighboring squadrons.

"The method in use in British squadrons is for a pilot on approaching an aerodrome, and wishing to descend, to fire one of his Very lights. The predetermined signal will be answered from the ground. If the signals agree, the pilot will know he is over his own drome and may accordingly land. If the signals do not agree, he will recognize from the color of the ground the signal of the aerodrome he is over. As every pilot should memorize the signals of adjacent aerodromes, this method will also assist him in determining his course for his own aerodrome. The distribution of landing flares is on the following system:

Three flares in line, s o	0	0	0
One flare in the R. H.	1	2	3
bottom corner, so			0
			4

"A pilot wishing to descend should know by prearrangement which of these flares are doubled so. There is a different one in each brigade. The various aerodromes and landing stations in a brigade are distinguished by the color of the Very lights fired from a spot adjacent to the double flare. Owing to military exigency, it is impossible to state more plainly the code on which this is based.

"Flare lighting is controlled by the Brigade Headquarters. They are lighted on receipt of orders, and are kept going until ordered out. At its discretion a Brigade Headquarters may request a neighboring aerodrome to 'flare up.' Pilots flying at night are individually responsible for informing their Brigade Headquarters of their safe atterrisage.

"Night flying is dependent largely upon the weather, but for our purpose can be divided into two categories—moonlight nights and otherwise. When conditions are good, and the moon bright, perfect night flying can be practised and observations taken easily up to a height of 9000 ft.; landing grounds and aerodromes can be seen quite plainly at this height, although on ascent the machine is quickly lost to view from below. So difficult is it to spot machines at night, unless carrying distinguishing lights, that

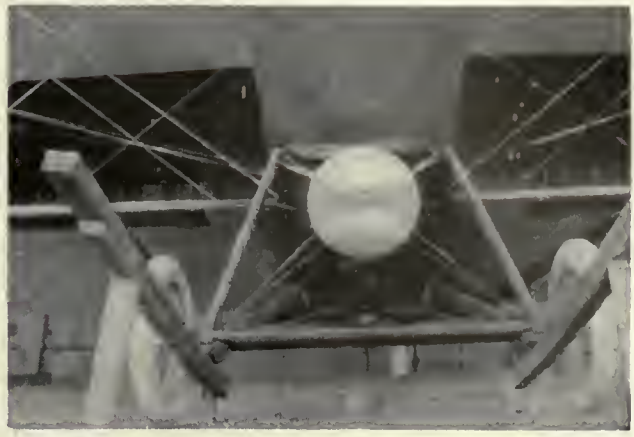

Aeroplane searchlight mounted on a biplane. The searchlight, 500-watt power, is operated by a wind-wheel and has no connection with the aeroplane motor. It is designed to be used as a signal light and to aid in making landings at night.

a hostile machine over the lines on one occasion could neither be seen from the ground nor the air. On occasions when our machines penetrate over the lines the enemy guns cease firing, presumably so that gun-flashes shall not be spotted. Under the most perfect conditions railways are difficult to see, but sometimes a train may be recognized by its white smoke.

"With no moon, at 5000 ft., it is not possible to distinguish railways, roads, or rivers; but aerodrome flares are quite effective at this

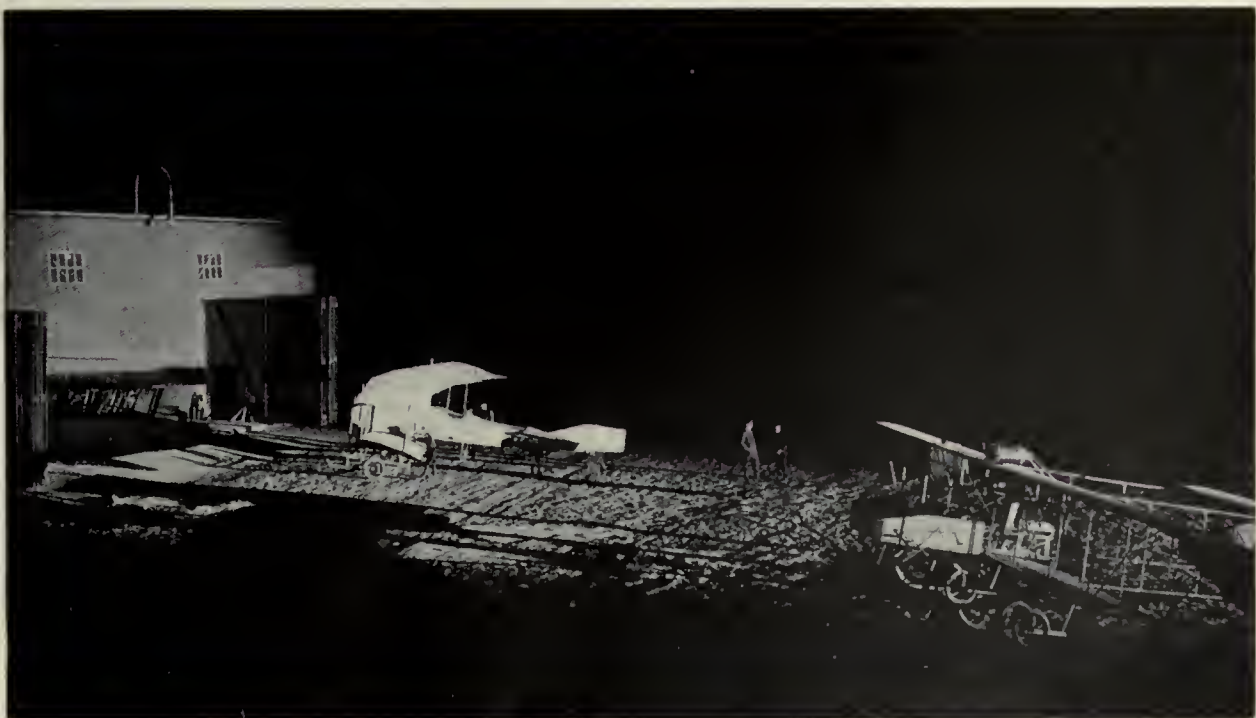

German aeroplanes at a German aerodrome at night.



A Taube at dusk.

height—in short, on moonless nights only lights can be seen. Even on “moony” nights, at 2000 ft. unlighted objects cannot be seen with any certainty on the road; yet at 7000 ft. on an ideal night, roads are clearly seen looking vertically down, and lighted motor transports are easily discernible. Villages and towns are also “on view”; the British trenches may also be seen with the aid of flares.

“The danger of keeping aerodromes ‘flared’ while machines are out on reconnaissance results sometimes in hostile machines (which cannot be placed) dropping bombs.

“We have by no means reached finality in the design either of parachute flares or wing-tip flares. Of two parachutes tried recently, only one burned, while the other flare, on examination, was found to be only partially burned; the latter flare ignited, burned steadily for a short time, and then went out, with half the

composition unburned. This is extremely dangerous, as it leaves the pilot in the dark just at the moment of landing, when he most needs the light. The arm of the flare is apparently too weak, and becomes bent in the course of flying. If bent so as to bring the flare close to the wing, it should work satisfactorily.

“In view of the landing difficulty, the suggestion that every aerodrome should be equipped with a portable projector is excellent. Provided the pilot is always able to land head on to wind, the beam remains pointed to windward. Great care must be taken to keep the beam stationary, as any glare in a pilot’s eyes would blind him and have unfortunate results.

“A closing hint to flight and squadron commanders might not be out of place here.

“Pilots detailed for night flying should have plenty of opportunity to practise on the same machines with which they will fly at night, and should be instructed to practise the following operations:

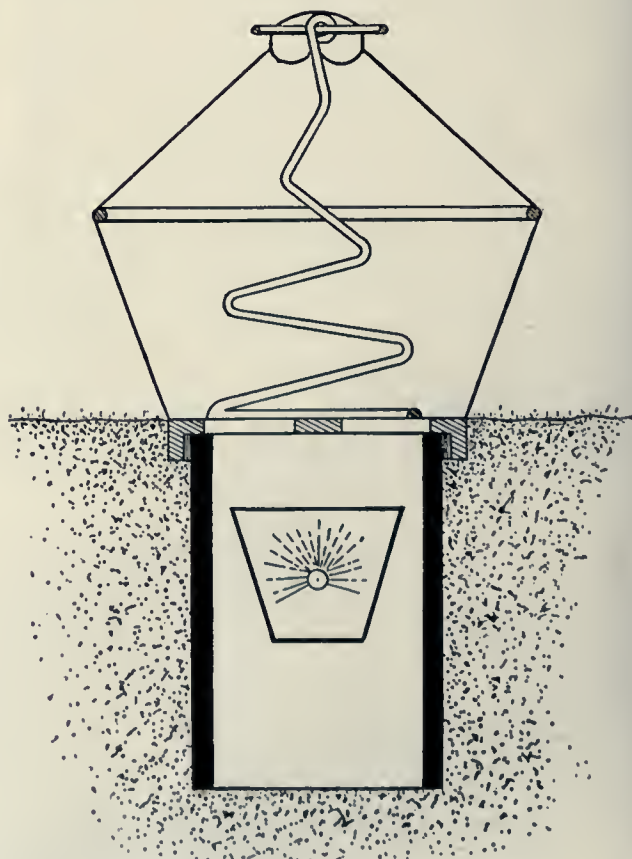

Cross-sectional view of one of the new German aviation beacons

Courtesy Scientific American

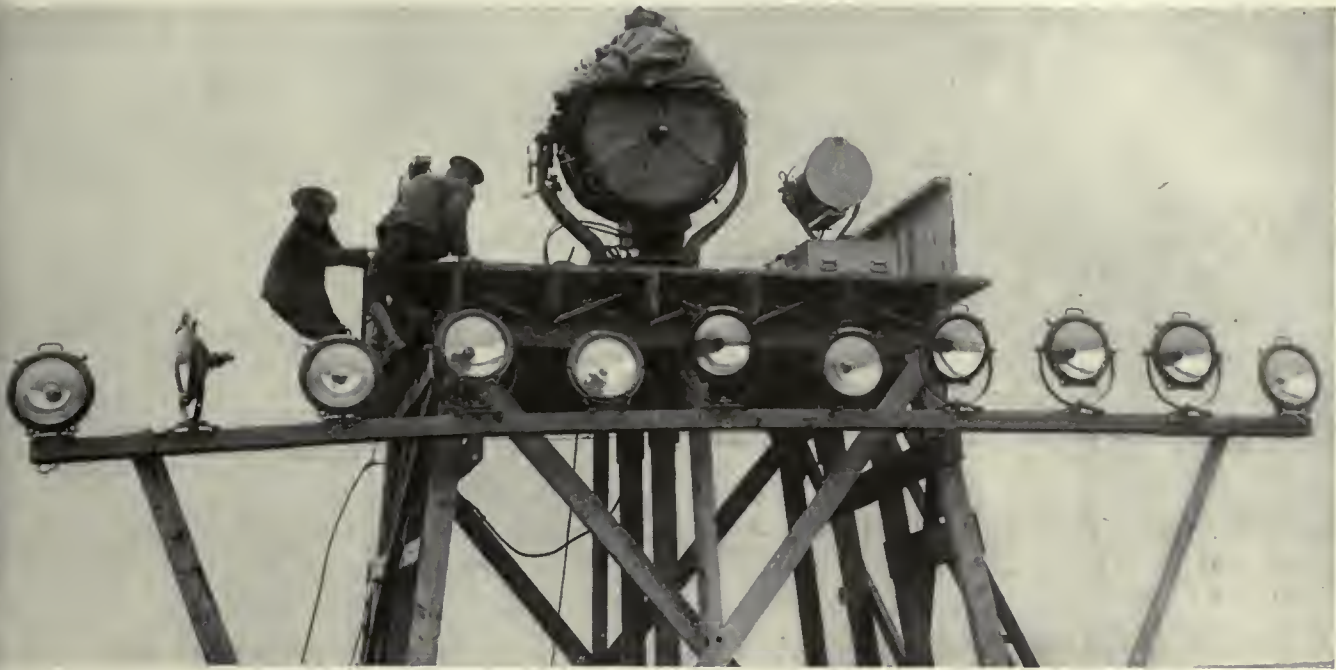

Lighting stand, serving the double purpose of guiding nocturnal flyers to a safe landing and detecting hostile aeroplanes.

1. Flying by instruments alone—i.e., without using the horizon as a guide.
2. Gliding slowly.
3. Making small sideslips and quick recoveries.
4. Checking the speed of the machine and identifying it with the sound of the wires under certain conditions.
5. Turning, using instruments alone.
6. Landing slowly.”

The “Hönig Circles” Signals for Night Flyers

The ingenious arrangement of signals for night fliers, patented by the German architect Edgar Hönig, was described in the *Technische Monatshefte* and translated in the *Literary Digest*. The apparatus consists of two concentric circles or rings of incandescent lamps standing on edge a few feet from the ground, with the smaller one placed at a distance of several yards behind the larger one, which stands back of the landing stage.

The working of this arrangement depends on the wellknown fact that a circle appears as an ellipse as soon as the eye ceases to be directly opposite the center. Hence two circles of light, arranged as Figure 1, must be perceived as two

upright or slanting ellipses which either intersect each other or have the smaller contained in the larger, until the eye of the beholder is directly in line with the axis passing through the middle point of the two circles. In the case of the

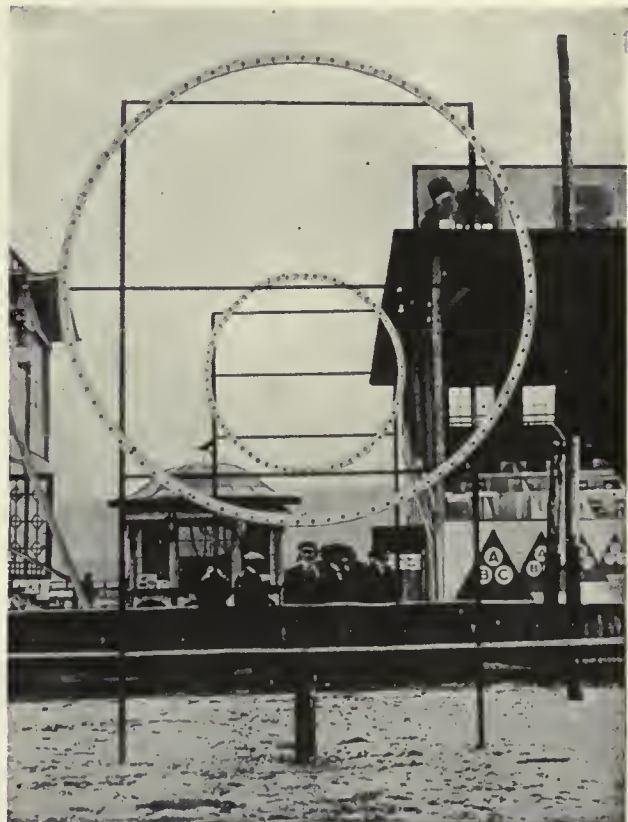

Photograph of the Hönig Circles.



2.—From above, the aviator sees two ellipses only.



3.—As he descends, the circles round out and cut each other.

Hönig Signal Circles whose central axis stands about 13 feet

above ground, this occurs when the airman is from two to three feet (according to the build of the machine) above the ground.

Figure 2 shows how the circles appear to a flier who finds himself at a great height above the signal and flies directly down in the direction of the central axis of the circles. When he comes farther down, probably flying in a spiral and thus nearing the ground, the rings begin to intersect, and appear to him, for instance, as in Figure 3. This position of the light-circles reveals to him not only that he has approached the earth, but also that he has diverged from the direction of the middle axis, and that he must steer his machine to the right in order to obtain



4.—“Earth level! Steer left!”

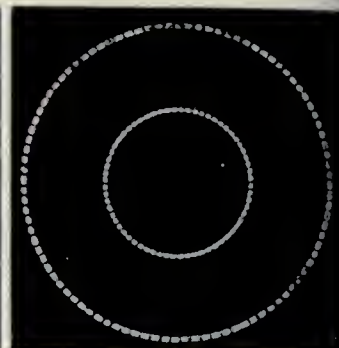

5.—“Home!”

the right direction again. He does this, still continuing to descend until he sees the signal, perhaps as in Figure 4. He knows then that he has approached the level of the ground. Consequently he steers, and the operation consists merely of turning on the current when a machine is heard approaching at night, in cases where the lights are not needed to burn continuously. Where the signal is part of the equipment of an aviation corps in an army, it is easily arranged so that the rings can be fastened together and transported without difficulty when camp is changed. The invention is likewise specially valuable for water landings.

Lights for Night Landing Grounds

Mr. Bright the British authority in his report on the best lights for night landing grounds says in this connection: “While undoubtedly the

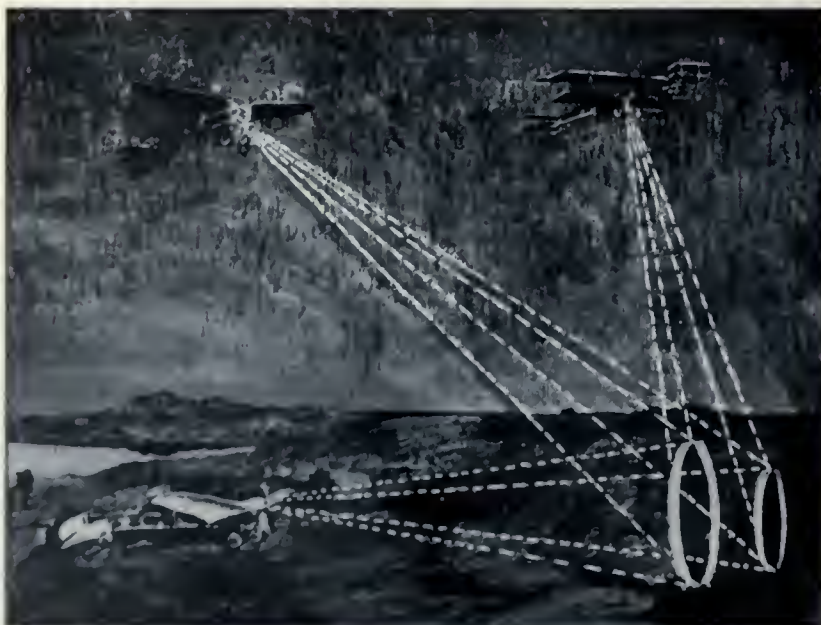

1.—How the circles of light guide the night-fliers. The relative positions of the two concentric light-circles reveal to the aviators, as the dotted lines show (and as the diagrams of the opposite page indicate), their angle of approach to the aviation-ground. See article on next page.

light obtained from the ordinary petrol flare is better suited for the purpose than the white light from a common arc lamp, the same does not apply in the case of the comparatively new flame arc lamps which are recommended for this purpose. The value of the petrol flare was settled as far back as 1885 when the South Foreland experiments were conducted at the instance of Trinity House (see "Report of the Committee on Experiments at South Foreland relative to Electricity, Gas, and Oil as Lighthouse Illuminants"). The new flame arc lamps give a yellow red arc when the carbons are made in a manner separately communicated. Indeed, the light produced by the yellow flame carbon has the highest penetrating power of any known illuminant, and has great advantages over all others (including petrol flares) in foggy or hazy weather. The light obtained from these special flame arc lamps (fitted with yellow flame carbons) is very near in color to petrol flares, but is considerably more powerful. A further important advantage in an electric lighting system of the special type named would be that, unlike petrol flares, all the lights can be simultaneously switched on and off at a moment's notice."

Returning from Night Flights—The Signals

To the aviator engaged in long-distance night raids night flying still holds difficulties to be sur-



Portable aerial beacon of 2400 decimal C.P.

mounted. There are a few difficulties however, confronting the aviator on "Zep duty" who does not venture far from his base. The long distance raider may lose his way in the darkness; the aviator on "Zep duty" only has to flash the signals, and since the landing stations in Great Britain and France are numerous, the signal is usually answered by one of the stations lighting up so that the aviator may land.

Naturally, the signals are changed daily. The authorities issue daily signals and the mechanics load the signal pistols accordingly for the aviators. The lights or flares can be seen from a distance of from ten to fifteen miles. Aeroplanes are also equipped with lights placed beneath the bottom wings and with automobile lamps so that in case of a forced landing they may come down with little trouble. These lights are turned down by pressing a button.

Lighting Equipment of Aeroplanes

The lighting equipment of aeroplanes varies considerably. Following are the British Gov-



A convenient French aerial beacon.



Aerial Lighthouse

ernment's specifications for the lighting equipment of certain battleplanes and the passenger's bay.

Electric lighting equipment. This will be fixed in a suitable manner. Dry batteries of the life of $4\frac{1}{2}$ hours to be provided to light up the dashboard. As the machine will not be flying for a longer period than 8 hours, the extra dry battery provided can be used in emergency. When these dry batteries are exhausted, they can be thrown away. They weigh about 21 lbs. each.

The lighting to be arranged as follows:

2. Lights to throw light on the instrument board, and arranged so as not to throw it in the pilot's eyes.

1. Light at the bottom of the fuselage, to throw light on the floor in case the pilot wishes to throw light there for any purpose. This is also to be shaded so that it will not throw light in his eyes.

1. Light for the compass, arranged in the same way.

1. Portable torch to be provided with each machine.

Instruments Painted with Luminous Compounds

The instruments used by aviators in night flying have the indicators and dials painted with luminous compounds, which eliminate the blinding glare of electricity and the necessity of using flash lamps. The parts so painted can be seen clearly by the pilot who for the time being is entirely wrapped in darkness.

Aerial Lighthouses

It is as essential that air men have lighthouses to guide them through the atmospheric ocean as for navigators at sea. The aerial beacons are of several types, the most powerful having a candle-power of 50,000 and being visible for upward of fifty miles. As the result of much experimenting a general type of beacon has been developed. It consists of several belts of lenses, with a powerful lamp at their focus which sends out its rays uniformly in all directions. It is necessary, of course, that the light be clearly visible to the air man, whether flying above or below the light. Each lighthouse must have a distinctive mark of its own, so that the air man will be in no danger of confusing them and losing his way. A series of light-flashes are thrown out, corresponding to the dots and dashes of the Morse code. The air man soon learns to read these signals, or to verify them by a code book, and can thus readily learn his position, even when the earth beneath him is completely hidden.

Adventures in Night Flying

Following is a letter from Lieut. Red. H. Mulock, R. N., the Canadian pilot who was the first to succeed in chasing a Zep at night, and did so at a time when arrangements for signaling between aeroplanes and aerodromes had not yet been completed.

"Dear ———

"We have had a little fun around here. A

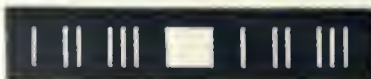

Signal, indicated by dots and dashes, flashed from aerial lighthouses.



Showing the luminous tracks of three aeroplanes landing at night at a military aerodrome.

week ago, or rather Monday, the 17th, a Zep blew along evidently looking for our aerodrome. We heard him coming and presently saw him flying in from the sea. I asked our C. O. if I could go after him, and got away with some bombs, grenades, and a revolver. He was steering about due south, so I laid a course east of south, and started to head him off. It was in the middle of the night—a little after 1 A. M. and no moon, very dark with clouds around and the stars so dark you could not see the horizon. He passed over here about 2,000 ft. up, and, by the time he got to — I was up even with him and to seaward. I then changed my course straight for him. He had stopped to drop his bombs on — and with his engine shut down, heard me coming, and of course, as soon as he

heard me, looked in my direction and must have seen the flames from my exhaust.

“Anyway he did not wait to throw any more bombs, and I saw the most wonderful sight. I was about 1,500 ft. from him. He opened fire with maxims, but without effect, and majestically stuck his nose up and went up like a balloon. He was then higher than I, so I opened out again, and tried to round him back again at —, where we both turned out to sea and steered about east. I chased him up to 8,000 ft. and over to the Belgian coast, and we both changed courses to S. E. and a little later went into the clouds together over —.

“Having lost him in the clouds, I climbed to 9,000 ft. and rambled around waiting for him. But he had gone. There were two of them;

one was given a warm reception by the chaps at —, while the other one and I had a picnic all to ourselves. He ran away so fast I could not keep up with him and climb at the same time. I waited around for him, but no Zep appeared; evidently he stopped his engines and listened for me, and then went off in another direction. There was no use waiting, so I started for home. I swung around out to sea from coast, going north by compass. It was very dark, and I could not see the sea or land and no stars or moon, as I was in the clouds. Talk about being alone in the world, very few people know what it means. I came down to 7,500 ft. and turned west finally, picking up some searchlights in the distance. I thought they were at — and headed for them, and after some time three big searchlights jumped out of the darkness below. Instantly I knew they were from a cruiser and were looking for me, having heard my engine. At night they fire on any one, as they cannot see our large red circles. So, not being particularly anxious to see how near they could come, I started to dodge the large beams and headed out north into the open sea again. I worked my way gradually back to the — and later on saw the — lightship, and then the coast, which looked very dim way down below, but it was home and once more I felt in the world.

"I could not come down for two reasons. First, it was not light enough to land and secondly, I knew I would be fired on if I went low. So I had to play around up in the sky over the sea 7,500 ft. up waiting for the sun to rise. As soon as it was light enough I came down and every one seemed glad to see me back, as they had given me up. I cannot begin to tell you all about it, as one has to go through a night like that to realize what wonderful things we have. I enjoyed every minute of it, and every minute was different.

"My engine gave out once over the North Sea but was able to keep her going slowly, and finally as I was gliding down to the ocean for some unknown reason, it picked up again. I was going to glide for one of the searchlights and land in the water alongside and be picked up by a torpedo boat, but luck was with me. Dodging searchlights over the North Sea is the finest sport in the world. Funny, isn't it, that we have to dodge our own guns and lights? They cannot distinguish between the Germans and ourselves, and take no chances, so they fire on any engine they hear in the sky."

Since the above was written arrangements have been made for signaling between aeroplanes and the aerodromes. Lieut. William L.



German portable gas beacon.



Aerial beacon with electric flashlight.



The aerial beacon at Johannistal, Germany.

Robinson who, on September 2d, 1916, brought down the first Zeppelin on British soil, in relating his exploit states that after seeing the huge airship fall, he looped the loop with joy, then, "showed my signals to stop firing, and came down to earth."

Memoranda:

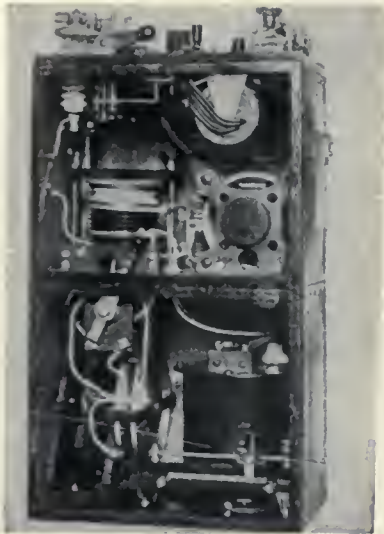

Fig. 9. Installation by German government.



Fig. 12. A motor car wireless station.

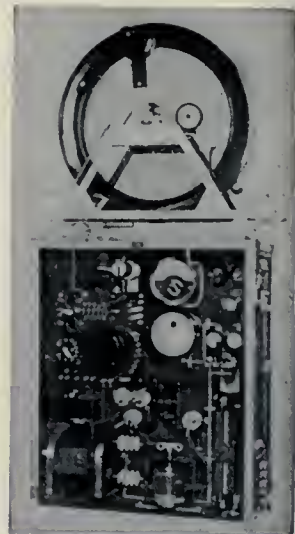

Fig. 10. Large 5 K. W. Zeppelin apparatus.



Fig. 11. A Zeppelin wireless outfit.



Fig. 18. Airman's helmet with wireless receiver.

Aero wireless apparatus.

The use of wireless for communication between aeroplanes and their bases has gradually become more and more necessary and to-day the aviators on all the fronts are equipped with the most improved instruments available. For every type of aircraft a suitable wireless set has been developed.



Fig. 19. Apparatus for seeing wireless signals.



Fig. 16. Early German Taube carrying wireless masts on wings.



Fig. 15. Wireless on 1913-14 monoplane used in Flanders.



A double-motored Caudron biplane used extensively for observation, in France. It is equipped with a Lewis gun.

CHAPTER XI

RADIO FOR AEROPLANES

By WILLIAM DUBILIER

Unless one has made personal observations as to the working of wireless and air craft in this present war, it is difficult to appreciate how the art of warfare has been transformed by these two branches of science; and, in turn, modern methods of fighting have changed the art of radio and aeronautic engineering. Recent events and progress of wireless communications have established this branch of science as an indispensable means of transmitting intelligence from one place to another.

Radio and aeronautic communication may be termed the nervous systems of the army and navy. Even for the directing of artillery fire and communication between trenches, it has been necessary to resort to electro-magnetic waves from aeroplanes. Problems have arisen

one day, and have been solved the next. One incident may be mentioned where, in the early months of the war, wireless stations were used for directing the artillery. The shots from the guns, however, were so constant and continuous that they caused disturbances in the atmosphere, which, in turn, seemed to affect the receptor of the wireless station, and so a continuous noise or click was heard, such as is produced by static. Immediately physicists were set to work and this objection removed, and so, many other problems in wireless have come up, as communication became necessary under different conditions, which enlisted almost every radio and aero worker in the fighting countries. They had no time to try out new apparatus, except where new conditions arose, and the instruments pre-



U. S. Army biplane used in Capt. Culver's experiments, showing radio apparatus and aerials.

viously used were not suitable; so immediately the departments were divided up into sections. The practical men were set to work installing and making stations as fast as the factories could turn them out, and the experimenters and physicists were ready to try out new apparatus and rectify new objections.

Wireless and aeroplane companies in France, England, and the other countries, except Germany, were not so numerous or as large as they are in this country, and so their output was soon limited, which was much below the demand. Everything obtainable was used for wireless. The old type induction coils, apparatus which was placed in the junk heap 10 years ago, all became very handy, due to the fact that the

Government was unable to obtain small sets, and that the radio companies paid so little attention to this branch.

For this reason England subsidized many of the large factories, such as the Sterling Telephone Company, and devoted practically the whole works to the manufacture of small radio outfits of the aeroplane type, under her own supervision. In Europe, as well as in this country, development in that direction had been very badly neglected up to the time of the war. All acquainted with the present conditions on the other side will admit that wireless and aeronautics is one of the most important assets, if not the most important, and it is the small radio outfit and the rapid machines which are making it so essential. I hope this Government and radio engineers in this country, will take advantage of this experience.

In all the small-power and portable instruments used, whether they were the old apparatus or the newly designed ones, the transmission has been in musical notes, and the spark-gap in every case was of a quenched type. Even in the 30- and 40-watt instruments, using a 12-volt storage battery with an ordinary induction coil, quenched gaps were installed. The copper discs were $1\frac{1}{4}$ inches in diameter, $\frac{1}{4}$ inch thick, with a sparking surface of about $\frac{2}{3}$ sq. in., and small mica rings for separators.

At first the wire telephone and telegraph were used everywhere, especially between trenches, but very frequently the wires were broken by shrapnel shell, and by the men themselves at night, for that is the only time when they dare



View of the cock-pit, showing arrangement of the Culver set which transmitted 119 miles.

leave the trenches, and there is little possibility to repair the damage. So wireless has proven to be the only uniform and trustworthy means of communication. Especially has it shown its usefulness to the flying machine, for almost every shot fired from the artillery is directed by wireless from an aeroplane, which is constantly flying over the battlefield, observing the shots and immediately signaling back if they landed too far or too near.

Both the Central Powers and the Allies have been using wireless trench sets. These must be transported and operated by one or two men. The transmission need not be more than five miles, but the aerials must be very low, and the instrument must be robust and adapted for rough usage. Several such instruments are now being supplied, the highest and smallest of this type weighing less than ten lbs. for the transmitter, under five lbs. for the receptor, and just over ten lbs. for the battery.

For aeroplane use great developments have taken place in the design of the instruments.

Two types are mostly being used by the English and French Armies; one having a power of between 40 watts and less and the other 150 watts. Recently installations have been made on the large aeroplanes built for England, the details of which cannot be made public.

In supplying wireless apparatus for aeroplanes, light weight and compactness are the most important requirements. The efficiency of the instrument is no longer measured by the power input to the power output. It is the distance to the weight, after considering reliability of action. To cite an example: it is interesting to note that the installation on almost all the aeroplanes used by the French Government is a very small and compact instrument in which old principles were revived, the same as used in first Marconi and Hertz experiments. There are no tuned oscillating circuits; simply a small induction coil with an independent vibrator, and the spark gap connected in parallel to an aerial and ground or counter capacity. This instrument is very largely used by the French Gov-



Students learning to direct artillery fire by wireless.
Photo Bureau of Public Information

ernment for directing artillery fire, where it is essential that the installations be of light weight, with a range of communication of from 12 to 15 km.

An independent interrupter is used, and musical notes are emitted with a frequency of about 300. The secondary of the induction coil has a very high inductance, so, when connected with the aerial and ground, it is in tune with the primary vibrating circuit. Across the secondary are connected the spark-gap terminals, mounted on top of a small metal case and on the outside of the instrument, so that advantage is taken of the continuous rush of air to cool the gap which is very small. This gap consists of a copper tube $\frac{3}{16}$ " in diameter, $\frac{1}{16}$ " thick for one electrode and a flat disc $\frac{3}{4}$ " in diameter for the other. By connecting the aerial and counter capacity directly across the spark-gap, the necessity of tuning is eliminated. The aerial wire system is an open oscillator, and has a capacity of .0002 mf.

The only essential change recently made was in tuning the vibrator and connecting the condenser across the interrupter and the primary of the induction coil, as in the Dubilier system explained later, instead of the condenser across the interrupter alone, as was customary heretofore. Under these conditions the efficiency of the instrument is considerably increased, and the reason for this will be shown. The battery is in a small case containing 10 six-ampere hour cells, the current of which is regulated by a small variable resistance. An ammeter indicates at all

times whether the set is in operation, and how much power is being used; which is usually 40 watts. With a capacity of .0002, the aerial wire system radiates $\frac{1}{2}$ ampere. The trailing wire, which is used as the aerial, is about 175 ft. long, and has a 2 lb. lead weight attached to it. The engine and all the other metallic parts on the aeroplane are used as the counter capacity. This instrument is used mostly for short distance communications by the rapid, light machines which are constantly circling over the trenches, and directing the artillery shots. Communication is held with the receiving stations situated about 1 mile behind the guns, and from there to the gunners a regular telephone line is used. This instrument is shown in Figure 1.

The position of the pilot and observer is very dangerous, as they must be constantly over the enemies' trenches directing the shots, if they are long or short, or too far to the right or left. It is surprising to see how rapidly and automatically the whole system works. As soon as the shots land, signals are immediately flashed back, and the next shot follows the corrected course indicated by the radio apparatus from the aeroplane. These flying machines must be very light and rapid, due to the dangerous service they render. They are usually two-seaters, containing the pilot and the observer, and so one will appreciate under these circumstances how essential a few pounds would be in the wireless installation. In constructing the condensers for these installations, the Government

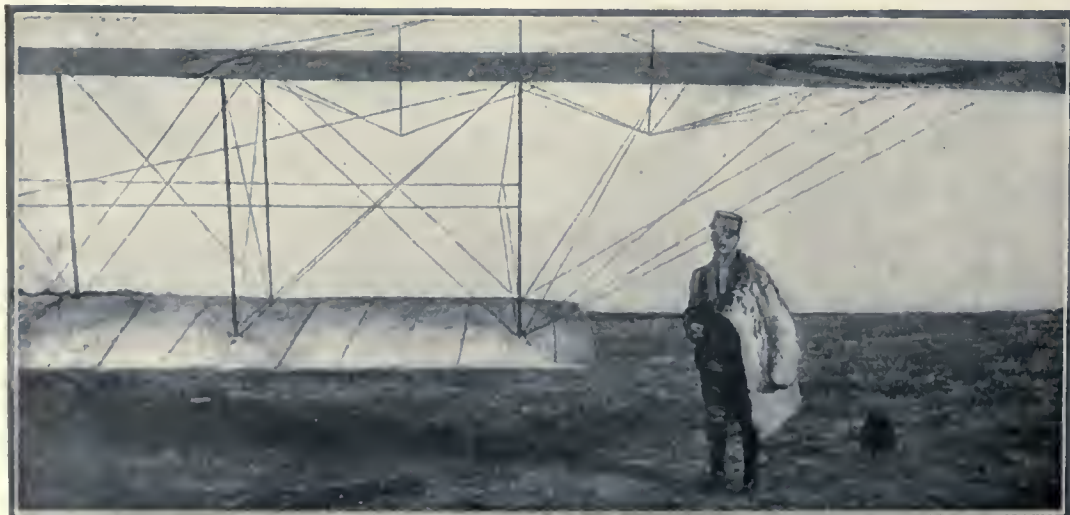

The transmissions and aerals on a French biplane.



Photograph of Zeppelin showing the aerial hanging down.

informed us that we must eliminate the aluminum castings which are used for compresses and heat radiators, and must cut the containing box down so that the wall is not more than $\frac{1}{8}$ ". We thus reduce the weight about $1\frac{1}{2}$ lbs., which satisfied them very much more than the former ones constructed from careful experiments.

I have been informed by the commanders that this aeroplane and radio work has been the most effective done in the war. It has been by means of this radio communication that it was possible for the artillery to break up the strong concrete trenches. I was in France when the famous Champagne district siege was begun, and the returning officers informed me that the German trenches were constructed as though they were foundations for large buildings, heavy concrete walls reinforced by steel; the only way it was possible for them to make any advance, was to completely break up these trenches, and only by continuous bombardment was it possible to get the men to move and make any advance.

The flying machines never stay out for longer than three hours; when they return the batteries are changed.

Another set of instruments used for aeroplane work, but of a much higher power, is one using the Bethenod resonance alternator. This outfit is shown in Figure 2, installed on a

French aeroplane. The special feature of this apparatus is the large power coupled with the light weight, which is made possible by the use of Bethenod's High Frequency Generator. The principle of this alternator is well known, and no further details are necessary.

This instrument is made in two different sizes. One weighing 35 kilos complete, about 77 lbs., has a transmission radius of 110 km., about 60 miles. The larger outfit, which weighs about 110 lbs., has a communicating radius of

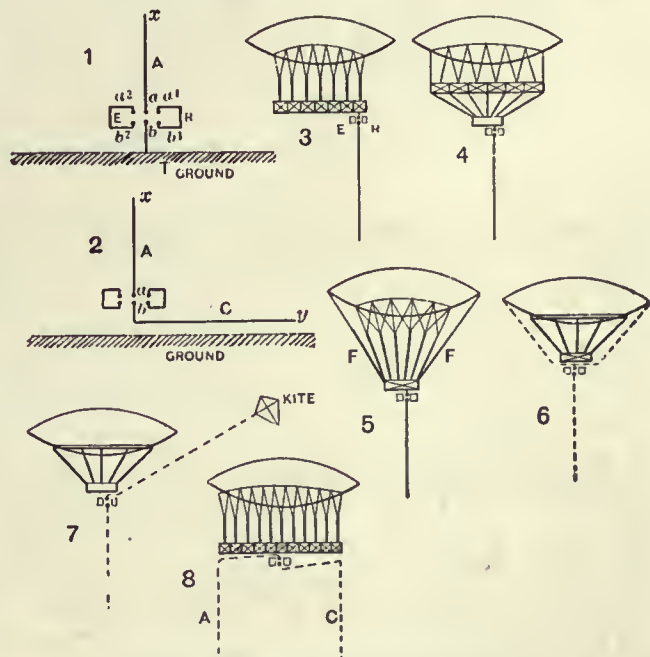

Methods of suspending aerials from dirigibles.



Two French wireless receiving trucks screened from the eyes of the enemy aviators by trees and branches.

about 200 km., about 120 miles. The generator for 750 watts outfit at 25 volts with a frequency of 1,500 cycles, is run at a normal speed of 4,500 revolutions per minute. The weight complete for the generator is 19 kilos, about 42 lbs., and can be overloaded up to 1 KW. Here is a generator with $\frac{3}{4}$ KW outfit, which weighs only 42 lbs., and using a very high frequency makes it possible to cut down the weight and size of the other parts of the installation. In the tests made with this instrument, communication was held from an aeroplane to a land-station for a distance of 100 miles, with a complete installation which did not weigh more than 110 lbs., so we have here a basis upon which to work; a weight of 1 lb. for each mile communication. The apparatus is constructed with a fairly good co-efficient of security, in order to support the shocks of vibration it has to experience. The sending outfit includes the generator, a transformer, an oscillating circuit, and an aerial wire system. The aerial consists of a bronzed,

braided wire, having a high mechanical strength, and hanging down and back of the aeroplane. The diameter of this braid is about 1 mm., and it is rolled on a very light and insulating wheel, as can be seen from the figure. The end is anchored by a 3 lb. mass which is so shaped that when the aeroplane is in action, the aerial wire is nearly in a horizontal position, thus having a minimum surface exposure. The wheel upon which this wire is rolled is fitted on a circular contact, with facilities for quickly rolling and unrolling the wire while sending, for by that means the aerial wire-circuit is tuned. In case of emergency, an insulated clipping is provided by automatically cutting off the wire. The counter capacity consists of all the metallic parts of the aeroplane connected together, which include the engine, the generator, and other wires used.

The apparatus, including the wheel, the clipping, and the frame, is so built that it is adjustable to any type of flying machine.



Looking inside a wireless receiving truck. Two officers are receiving messages from aero observers and transmitting them to the battery. One of them is shown making a record of the information on his chart of the sector, which corresponds with the chart used by the observer.

The transformer is of a close core, air-cooled type, without magnetic leakage, and due to the very high frequency (1,500 cycles), it is made very light and small (Figure 2). The oscillating circuit is constructed for a maximum wave-length of 500 meters, when a condenser of .012 mf. capacity is used. The inductance consists of a flat helix, with an insulating handle for continuous variation for changing wave-lengths. An interesting feature of this instrument is the spark-gap, which is shown at A in the figure, and consists of a tube and plate. It is so constructed that the system of ventilation, that is, the rush of air which is generated by the aeroplane in motion, is used for quenching the spark. The tube end of the spark has a funnel, B, into which the air rushes. The primary power supplied is 30 amperes at 25 volts, and the secondary voltage 3,500. A small, light-weight key is designed for manipulation, and by means of a rheostat, the musical note of the spark can be changed from a deep sound to a whistle. The oscillating circuit, as shown in Figure 2, contains the hot wire ammeter, the condenser, the inductance, and the spark-gap mounted on a separate frame. The sliding contact is shown at E, and is so constructed that, when revolved, the springs are expanded and it slides easily over the ribbon, a very desirable feature in constructing sliding contacts for flat inductances. In the very beginning, tube condensers were supplied, but now the English, French, and American Governments are specifying Dubilier condensers for aeroplane installations. The condenser is one of the most im-

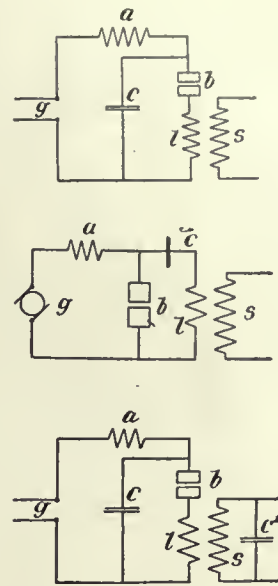
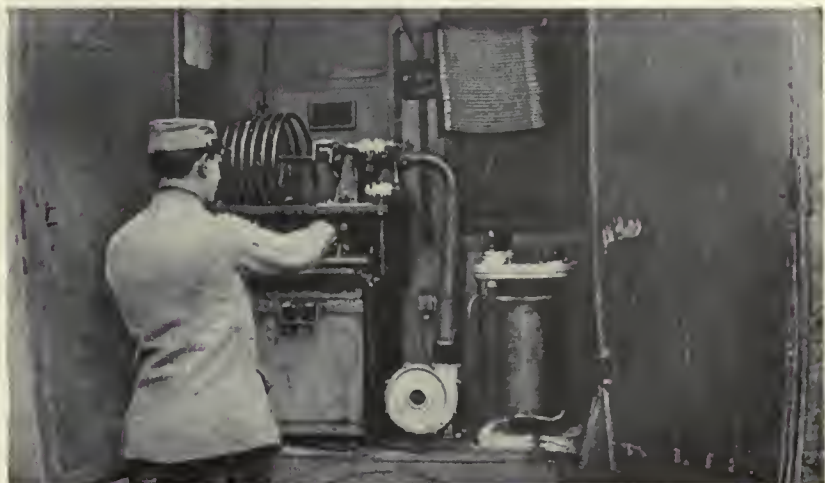

Fig. 4.

portant parts of the outfit, for not only must it be unbreakable, but of small size, light weight and highly efficient. For that reason I will devote a little time to explaining the construction of this condenser, which is used now in almost every aeroplane installation.

In constructing condensers, the space, weight, and resistance must be kept very low, and hysteresis loss and brush discharge must be practically eliminated. Also the condenser must be able to stand up, and not change its capacity after usage for a certain time. The British Government specifications call for a condenser that should be well built, within 5 per cent. of the specified capacity, and that capacity should not change 5 per cent., after strain by a continuous overload, for one hour. Only certain adhesive insulation is permissible, as waxes tend to

Partial view of the receiving apparatus inside of one of the wireless trucks.





The reel and long copper tube of the Culver set through which the trailing aerial is paid out. This reel has now been replaced by one carried in the cock-pit.

greatly increase hysteresis loss. As the capacity is proportional to the dielectric constant, this should be kept as high as possible for a given weight and size. It should have a very high specific resistance, and a low internal resistance, and be able to withstand twice the voltage. As the hysteresis loss in the condenser increases as the square of the voltage, it becomes a serious problem when capacities for high voltages and high frequencies are desired. The resistance must be kept as low as possible, and if the condenser is to be enclosed, which it is, all losses must be kept low, in order to prevent serious heating. Furthermore, means must be provided for radiating the little heat which is generated, and so the condenser is constructed to be able to stand a certain rise in temperature without harmful results. Under these conditions only homogeneous dielectrics can be used. No air or water must be allowed to find its way near the dielectric substance, since only a small trace is liable to reduce the strength and efficiency.

The set most used by the Allies on aeroplanes, and which is probably the most interesting of the portable installations, is one designed and built by a Mr. Rouzet. It is shown in Figure 3. These sets are made for various powers, but the one most supplied has a capacity of 150 watts, the energy being obtained from an alternator driven by the aeroplane engine. While various installations for this capacity are being made by the Governments, this set deserves much consideration, especially on account of the remarkably low weight. The complete transmitter, including the self-exciting generator for 150 watts, weighs only 17 kilos, about $37\frac{1}{2}$ lbs., which is less than $\frac{1}{2}$ of the weight of the smallest set made in this country up to 1916. This installation utilizes a 250-cycle self-exciting alternator, driven by a belt, and is of a remarkably light construction, having an armature with two commutators, one being for D. C., used for exciting. On the shaft of the armature is mounted a synchronized spark-gap, from which a group frequency of 500 is obtained. The key is connected in the field of the generator. The transformer is close-cored, oil-cooled, and is enclosed in a fiber tube as shown in Fig. 00. The condenser and the tuning coil are very light but rigid.

In testing the instrument, I found at the end of 10 minutes the frame became overheated. However, the cooling effect obtained by the aeroplane traveling through the air at the rate of 60 miles an hour is taken advantage of, and under these circumstances the apparatus works very well. In my opinion the army and navy should utilize such an instrument for aeroplane work.

By means of a standard aeroplane aerial, I have seen this outfit radiating $1\frac{1}{4}$ amperes, communicating a distance of 50 miles. This transmitter was designed with the aim of realizing a commercial system in which there will be no special or peculiar factors. A simple alternator is used, which easily permits the production of a high-tension current necessary to charge the condenser, which, in turn, produces high frequency oscillations by means of a synchronized gap, a condenser, and inductance. The resonance of the different factors is very

essential, and the following points were considered in originally designing the apparatus.

First, the condenser is charged in the most favorable manner.

Second, the condenser is discharged through a suitable circuit at the most favorable moment, and,

Third, the injurious results which accompany the discharge of a condenser, and the operation of such an instrument, were reduced to a minimum.

This was accomplished by the use of a synchronized spark-gap which is attached to one end of the shaft of the generator. This gap is made minutely adjustable, in order that the discharge may take place at the most favorable moment, the reasons and characteristics of which are well known. In the design and construction of this gap, the resistance is reduced to a minimum at the instant of the discharge. Then an air blast is thrown at the gap after the first few waves have passed. The duration of the discharge is reduced to a minimum by pointing the spark electrodes.

All the factors in the instrument are carefully tuned, such as synchronizing the spark-gap, which permits of the proper time of discharge and also the time of charge, corresponding to the variations of the alternating feeding current. This, of course, is the most important feature of the instrument. The time of discharges are regulated not only by speed, but also by placing several gaps in series on the same wheel.

The generator is driven at a speed of about 4,500. In the construction of the apparatus

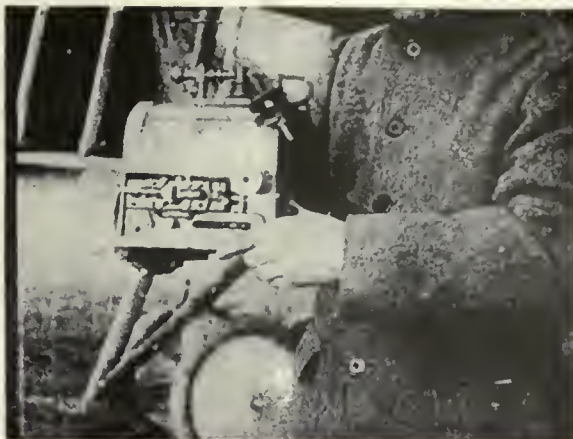

A French wireless set about to be mounted on an aeroplane.



The set being mounted on the aeroplane.

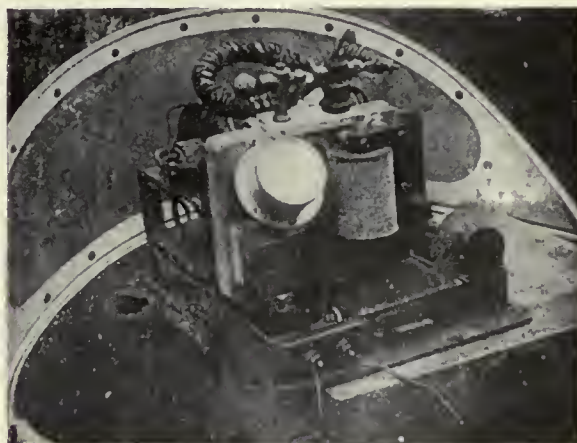

The set mounted on the Maurice Farman biplane.



One of the French machines used for wireless signaling.



The observer operating the wireless.

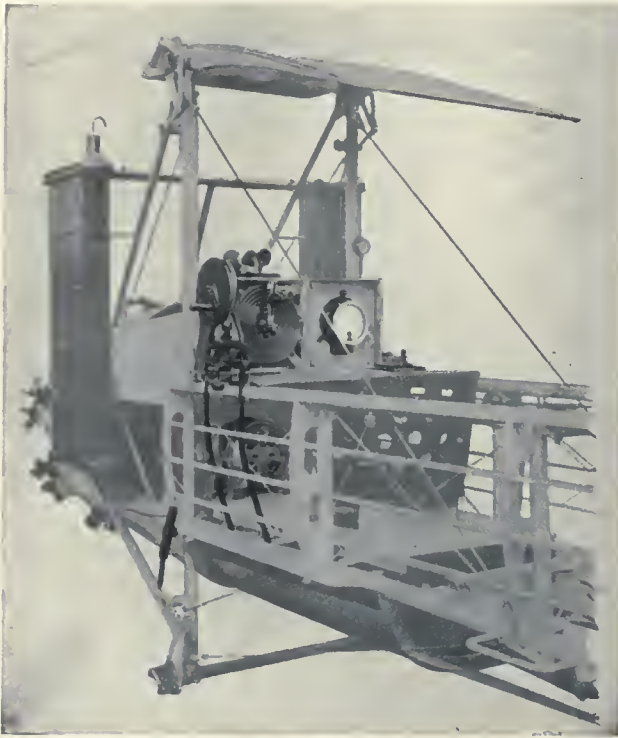

Powerful wireless apparatus installed on Bréguet aeroplane.

aluminum is used wherever possible, even for the aerial, the length of which is usually about 60 meters. The installations are supplied for aeroplanes with capacities up to 1 KW, and consist of the following parts:

The generator, with synchronized gap at the end of the shaft, a transformer, a condenser, variable inductances, accessories, such as connectors, hot wire ammeters, antennae parts, including the guide.

The total height of a 400-watt set is $12\frac{1}{2}$ inches, length $17\frac{1}{2}$ inches, the width, including shaft, 16 inches. It has a remarkably low weight of 55 lbs., and including the accessories, 70 lbs.

A smaller installation, having a capacity of 80 watts with a height of 9 inches, a length of 12 inches, and width of 10 inches, and a total weight, with accessories, of 33 lbs., is able to communicate a distance of 15 to 20 miles.

The 1 KW installation has a height of 21 inches, length, including shaft, $18\frac{1}{2}$ inches, and width 15 inches. The weight of this set, complete with accessories, is 132 lbs., remarkably low for such a big capacity. The length of waves can be varied up to 600 meters. The distance of communication for such an instrument

is about 200 miles from dirigibles, and over 100 miles from aeroplanes.

One will note the remarkable characteristics of such a high-powered instrument, especially the low weight and volume. Taking these factors into consideration, radio engineers will see that this instrument in efficiency, as compared to weight and distance, is far greater than anything yet installed. In general, the question of efficiency for aeroplane installations resolves itself down to two points,—weight and distance.

What does it matter how much power is used or what does it matter what wave length is generated, so long as efficient transmission can be had over the greatest distance for a given weight? That instrument is the best. If one could build a 1 KW set which only weighed 25 lbs., but which did not communicate for a greater distance than the low-powered sets, there would be no gain or no advantage in making a high-powered set of light weight. So long as the two factors, distance for given weight, are very efficient, the instrument is efficient; and we hope in the future the lessons taught will be considered by designers of radio instruments.

In the early days of the war, when it was found that aeroplanes had become such an important factor for defensive and offensive purposes, the commanders and the aeroplanes called for a reliable instrument which will transmit intelligently, but which will have a very light weight. The outcome of this was the instrument above mentioned.

The current generated by the alternator, which is self-exciting, is fed to a close-core transformer at 120 volts, the secondary of which charges the condenser at about 12,500 volts. Troubles usually present in stationary spark-gaps are eliminated. Air currents caused by the rotation and the movement of the aeroplane greatly assist the detonization of the spark-gap and cool the electrodes; hence it is possible to use a large current without danger of arcs forming. In this particular apparatus the gap-length is less than the length which the potential used can jump across. Since this gap is revolving at a very high speed, a short-circuiting effect takes place, for, when the projections of the re-

volving electrode approach the stationary electrodes, the discharge takes place, and the distance becomes shorter, the gap resistance and the energy consumption being reduced to very low values. This instrument, therefore, combines the two advantages of comparatively high initial voltage with a relatively short average gap-length; when the oscillations of the discharge have become very low in amplitude, the gap-length is very short. The value of the inductance is very important in the operation of this gap, for it is necessary to carefully regulate the retardation of the discharge.

The possibilities of radio engineering would be greatly extended if a small, simple wireless outfit were marketed, which could be used for short distances up to 100 miles and utilizing direct current, which is available on almost every ship, and which is much easier to generate.

With this object in mind, the following apparatus was designed. The idea occurred to me, in experimenting with condensers across the interrupter of the ordinary induction coil, that if the oscillations set up in this condenser were

passed through an inductance, and the time period made the same as the vibrator, the efficiency of the ordinary induction coil would be greatly increased, for, although this instrument has been in use for a good many years, it is well known that the ordinary induction coil is very inefficient. It was to utilize the current wasted in the condenser that I conducted a series of experiments in 1909, which led up to the following system.

I found that by means of tuning the oscillating circuit across an interrupter, or any kind of a condenser-charging device, that sparking and arcing are almost entirely eliminated, and that musical notes can be obtained, especially on the smaller type instrument, up to a very high pitch. Due to this tuning of the oscillating circuit, the efficiency, considering the power input to the power of the aerial, is greatly increased, for in the very beginning we eliminate the great loss which is common with a small motor-generator set for producing musical notes. In order to obtain the properties and characteristics of the musical note from direct current by an ideal im-



An aeroplane being used for artillery fire. The aeroplane circles over the firing batteries and the observer watches the effect of the shots and directs the man behind the guns by wireless.



Lightweight wireless vibrator for aeroplanes.



Fig. 6. Compact form of wireless unit.

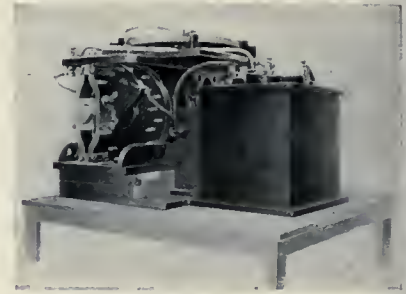

Fig. 7. Wireless aero transmitter.

pulse excitation, the connections are made as shown in Figure 4. *G* is the direct-current source which passes through an inductance, *A*, an oscillator or condenser charging device, *B*, another inductance, *L*, which acts as the primary of the transformer, and a condenser, *C*. In the small-type apparatus the inductance, *A*, acts as an electro magnet for operating the oscillator, *B*. We now have an oscillating circuit, *BCL*. *C* is made variable so that it can be tuned to a desired frequency, which, supposing, for example, is 500 per second. The condenser charging device, *B*, has a working frequency of its own, and the two elements, that is, the oscillator and the oscillating circuit, are brought into resonance. Then, and only then, a steady and even current is produced in the secondary of the transformer, which charges a high-tension condenser. On types of apparatus using up to 500 watts, a magnetic mechanical oscillator can be used, and in this case the electrical frequency of the oscillating circuit, *BLC*, will control to a certain extent the mechanical frequency of the oscillator. That is to say, it will force the oscillator to charge and discharge a condenser at a desired frequency, so as to keep in step with the current. The reasons for this will be explained later.

Mechanical interrupters and condenser-charging devices can be considered as variable resistances. In the operation of an ordinary induction coil, care must be taken to obtain in the interrupter the greatest possible variation of potential. This is generally prevented by the currents at the so-called opening spark. Heating troubles are experienced at the contacts and

arcing occurs. When the contacts of an induction coil are opened, a small arc is formed, and if the current is over 2 amperes, we have a potential difference of about 50 volts. This remains continuous, even if the contact is opened by a millimeter or two. With weaker currents the arc potential is higher, so that with the small working potentials only small opening sparks occur. To remove this arc and to obtain higher potentials at the interrupter, condensers are connected in parallel. When the contacts are opened, the arc rarely exists below 50 volts, but in the meantime, however, the point of contacts have already been extended, and the potential difference rose to several hundred volts. If, however, inductance is added, we will have currents stored up in the condenser which will discharge in a certain time, depending upon the values of the inductances and the capacity.

I therefore tried to obtain a condenser-charging interrupter which would operate when practically no current was passing, to prevent any potential difference occurring immediately after the interrupter was opened and closed; either case of which would cause the current to jump across the small air-gap. This condition can be fulfilled by means of the resonance oscillator and

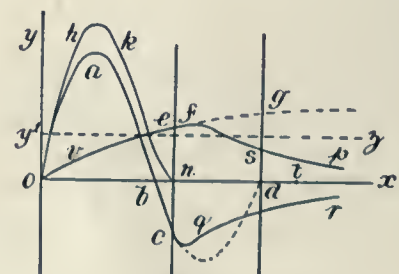

Fig. 5.

circuit. Figure 5 shows a curve of the different currents, and the action taking place in the operation of the apparatus.

OY represents the currents and OX the time. For the purpose of illustration, suppose the origin to commence on the moment when the condenser of the tuned oscillating circuit is fully charged, and the oscillator is closed. If this oscillating circuit were kept closed permanently, the condenser would discharge through the oscillator, and the primary of the transformer as a damped wave, indicated by the curve OABCD. At the same time the primary current gradually rises from zero, according to the ordinary exponential law, as shown by the curve OVEFG. In this type of apparatus the inductance, A, acts upon the oscillator, so that OY' represents the current through the magnets necessary to produce a force equal to the controlling force of the spring.

In all types using an electro-magnetic-controlled oscillator, A is the magnet coil operating on a spring which controls the oscillator, D. Let OY' represent the current through the magnets necessary to produce a force equal to the controlling force of the spring. This is also shown at E. The magnetic force of the coil, A, however, must be a little more than the force of the spring, in order to control it. This is shown at F. When the primary current through the magnet coil, A, reaches this point, F, the oscillator is opened.

For there to be no sparking or arcing at the oscillator, there must be no current flowing when it opens. Adding, therefore, the two currents,



An improvised receiving station constructed with aeroplane packing boxes.

going through the oscillator and the primary of the transformer, represented by the curves OABCD and OVEFG, we get OHKEN, the curve of the total current. This curve, it is seen, falls at zero when the ordinate NC is equal to the ordinate NF. It is therefore evident that, by varying the capacity E and the resistance or inductance of the primary current supply, which determine the curves OVEFG and OABCD respectively, it becomes possible to so adjust the factors that OHKN reaches zero at the instance of rupture of the circuit, and under these conditions there will be no sparking at the oscillator.

The primary current through the coil A does not cease instantly, but slowly dies away as the condenser, C, charges, such as is shown by curve FP. This is the charging current for the condenser. We complete the corresponding curve, CQR.

This charging current flows through the coil A and serves to retain the oscillator, thus keep-



A "T. S. F." (telegraphic sans fils) post which receives the messages from the aero observers and transmits them to the gunners on the French front.

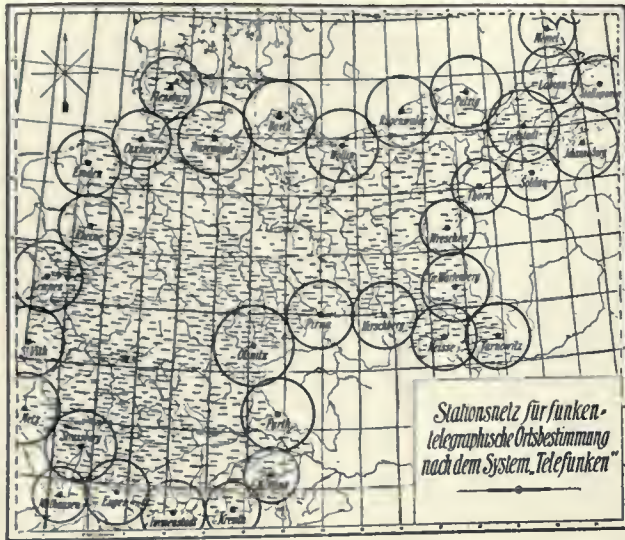

Permanent German wireless stations, used by Zeppelins before the war. It is understood that the number of these stations has been increased greatly since the war.

ing the oscillator open until some such point as *S* is reached, the ordinates *OS* being slightly less than *OY*. Here the oscillator closes again and the operation is repeated, commencing from the point *D*.

From the above it is obvious that the inductance, *A*, resistance, *R*, and capacity, *C*, play important parts for the smooth operation of this instrument, and this is very well proven by experiment. Further in order for the note to be a pure one, it is necessary that the second cycle must commence precisely at the point *D*, and this can be secured by varying resistance *R* and the tension of the oscillator reed.

Furthermore, it is at once seen that if the ca-

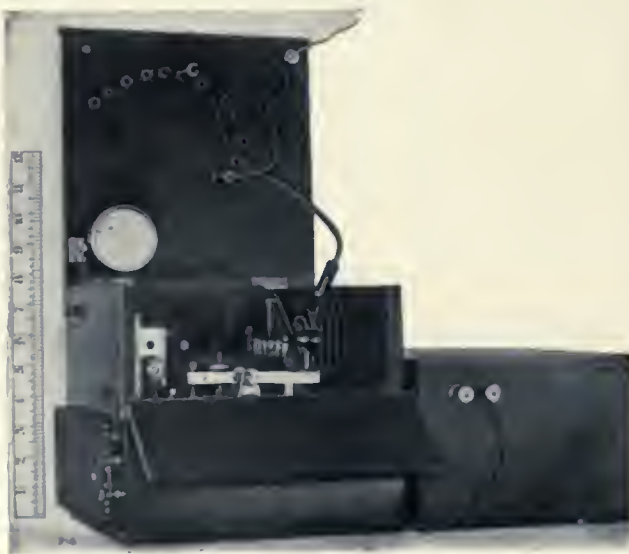

Wireless receiving apparatus.

capacity, *C*, is increased, the curve *FSP* will decrease less rapidly, and consequently the effective duration of the current through *C*, represented by distance *ND*, will be increased, and therefore the contact will remain open for a longer period, closing at some such point as *T*. But the curve *OABCD* will also have a greater time period, and will therefore approach zero at some point near *T*, so that the effective frequency of the oscillator is lowered. Resonance is then obtained by re-adjusting the primary resistance *R*, or spring, on the oscillator.

If the voltage is lowered, the new curve of rise of the current will not reach so high an amplitude; hence the time it is above the line *YEZ* would be shortened and the frequency increased, but resonance is again obtained by increasing the capacity.

The same result can be obtained by revolving commutators, but in this case the time of contact and the time that the circuit is open must be regulated with the primary curve and the condenser capacity. Then practically the same results and curves can be applied.

Going back to Figure 4, by substituting an oscillator at *B*, which has a continuous varying resistance, such as a microphone-carbon cup, it can be seen at once that sine waves could be generated at *S*, whose frequency will be equal to the frequency of the oscillating circuit *CLB*. The frequency, however, is limited by mechanical action, but for laboratory use, I have constructed a small oscillator whose movements are very small, but sufficient to produce alternating frequencies almost beyond audibility. In using revolving commutators, the amount of frequency that can be obtained depends upon the speed and the size of the contacts, so that in order to obtain radio frequencies with such an apparatus, almost cannon-ball speed would be necessary, which is mechanically impracticable, although the contacts can be very small for large powers, and may be divided into any number, making and breaking at the same time. If it were possible to make and break the circuit, at a radio frequency, under this system an ideal wireless outfit could be produced, with efficiencies unknown heretofore.

Figure 6 illustrates a little instrument used on



During the Balkan War aeroplanes were first used to spot artillery fire.

aeroplanes with direct-current storage-batteries, 30 volts.

An Allied Government has ordered a number of these sets for aeroplane work which utilize a small direct-current generator. This is the simplest form of generator suitable for aeroplane use, as it takes up smaller space and is of lighter weight for a given power than any other sources supplied. The instrument used is shown in Figure 7 and operates on the Dubilier principle of producing musical alternating currents from direct, without the use of a motor generator set. The complete weight of the apparatus is 32 lbs. for 150 watts, which is sufficient to communicate

a distance of over 50 miles. In Figure 7, the operation of this instrument is the same as shown in the diagrams. The quenched spark gap, A, is one especially designed for aeroplane



The Cutting A Washington aerophone radio set.

instruments, for it combines a large sparking and cooling surface with light weight and small space, and consists of a long, flat, copper, casting-bar separated about .005", between which the sparking takes place. A is a hot-wire meter which will indicate at all times the amount of current which is being radiated, and D is the primary current which shows how much power is being consumed.

Experiments were tried both in France and in this country in using an aerofan to drive the generator for the source of supply to operate the wireless instrument.

A patent recently issued to F. W. Cotterman comprises a generator for use in aeroplane work, wherein constant potential is obtained irrespective of the speed of the generator by means of gears.

Figures 9 and 10 show installations used by the German Government.

Figure 11 shows the method of suspension from the Zeppelin. Great care must be taken here that sparks and induce currents do not ignite, because at first it was thought utterly impossible to install wireless apparatus on balloons, on account of this danger. Figure 11 shows the method of suspension wherein the instrument is entirely isolated from the bags.

In connection with aeroplane work it is necessary that automobile stations be equipped so that they can communicate with these aeroplanes



The fan-driven generator, for the Culver set, which furnished power to send messages over a distance of 140 miles.

from the field, and if necessary be quickly movable. Figure 12 shows an interior of an automobile equipped with a 2 KW transmitter, which can communicate up to a distance of 150 miles or so.

Germany has long foreseen the possibilities of wireless communication in connection with aeronautics and for that purpose has established a chain of stations around Germany which are in constant touch with aeroplanes and balloons, the same plan we are now trying to carry out in this country. It may be interesting to note that this is very old and has been utilized in Germany years ago. Figure 14 shows the location of all the wireless stations around Germany, especially used for aeroplane and Zeppelin communications.

Many experiments have been made to find out the best possible method of mounting aerials for radiating along surfaces. The most convenient and general all-around efficient means is to drop a trailer, and to use the rest of the metal parts of the aeroplane as the counter capacity. Figure 15 shows a wireless aerial on a Flanders aeroplane, and it may be interesting to note that this picture was taken two hours before both the pilot and the operator were killed by the same machine falling.

Figure 16 shows a German Taube. Here can be seen plainly how the aerial is mounted on two small masts on the extreme of the wings.

Figure 17 shows other methods of suspending aerials, and methods of transmitting electromagnetic waves from air-vessels.

For aeroplanes it is practically impossible to receive signals, and never necessary. It is only important to send, and very rarely does an occasion occur where the operator or pilot has need or time to receive messages. However, many attempts were made to produce instruments which would make it practical to receive on aeroplanes, but up-to-date no such instrument has yet been perfected. On account of the noise due to the engine and the wind, it naturally becomes very difficult to distinguish signals by means of the ear. Figure 18 shows an airman's helmet, where the receivers were constructed right inside the head-gear, with cushions all around to eliminate the noises, but then the vi-

brations of the body and slight unavoidable noises transmitted directly through the body make it impracticable to receive in this manner. However, it is not impossible to make an instrument wherein the received signals can be distinguished by means of variation in light, for vibration and noises will not interfere with one's sight. Experiments have been conducted along these lines, receiving the wireless signals by an illuminating method, and Figure 19 shows an instrument constructed on the principle of an eithoven galvanometer, wherein the operator looks into the two eye-pieces and can see the movement of lights, indicating dots and dashes. This instrument, however, is not perfected as yet so as to be called practicable.

Due to encouragement given radio engineers by the radio division of the United States Navy, an apparatus has recently been developed in this country which is far superior to any used in Europe. Of the different installations recently

purchased by the Navy, three different principles were utilized for the protection of electric oscillations.

The apparatus supplied by the Marconi Co. and E. J. Simon of New York, uses a 500-cycle generator, the former with 1 KW capacity, sufficient to communicate about 300 miles, weighing complete, with generator, 100 lbs., while the latter with about 750 watt capacity, 250 miles distance, weighs complete 100 lbs.

Apparatus, using a glass bulb-generator, has been supplied and built by the De Forest Telegraph and Telephone Co. and Western Electric Co.

Apparatus using direct current, designed and patented by William Dubilier, is being supplied by the Sperry Gyroscope Company. It utilizes the quenched-arc principle and a complete installation, weighing about 65 lbs., with the generator of 500 watt capacity can radiate over 6 amps., and communicate about 250 miles.



A Zeppelin over Berlin. In the foreground is the Hindenburg statue.



An American "Blimp" and observation balloon at the Goodyear School, Akron, Ohio.
Passed by the Censor.

CHAPTER XII

MILITARY AEROSTATICS

Military aerostatics comprise three branches, as follows:

(1) *Dirigibles*, which are used extensively for night scouting, bombing, and, to some extent, for transportation of military personnel and material to otherwise inaccessible places;

(2) *Captive Observation Balloons*, which are used for directing artillery fire, and for general observation;

(3) *Spherical Balloons*, which are now used only for training captive balloon and dirigible pilots.

Dirigible Balloons

Hundreds of dirigible balloons, ranging in size from the small "Blimp," about 180 feet long, to the huge 700 foot "Zeppelin," are used in the present war. The "Blimps" are used mainly for coast patrol and convoying ships, by day and by night; and the large Zeppelins are used in night bombing attacks and in naval operations.

In France, Russia, Italy, Germany, and Austria, there are military dirigibles, differing in form from the naval dirigibles. In Great Britain all the dirigibles are in the navy.

The United States was one of the first countries to build a dirigible for military purposes. Bids were invited in 1907-08 for a dirigible for the army.

Rigid, Semi-Rigid, and Non-Rigid Dirigibles

Three types of dirigibles have been used by the European countries: (1) the rigid; (2) the semi-rigid; (3) the non-rigid.

(1) The rigid type of dirigible is one in which the shape of the gas compartments is maintained by means of rigid framework, such as the Zeppelins and Shütte Lanz. For de-

scription of the latest Super Zeppelins, see chapter on Naval Airships, "Textbook of Naval Aeronautics," Century Co. publishers.

(2) The semi-rigid dirigible has a rigid longitudinal frame usually immediately below the gas bag; this frame serves to distribute evenly the ascensional strains against the supported weights of engine, passengers, etc., to prevent buckling of the gas bag which in most dirigibles of this class depends upon internal gas pressure to maintain the shape of the envelope. The French dirigibles of the Lebaudy class are examples of the semi-rigid type.

(3) The non-rigid dirigibles depend entirely on gas pressure within the envelope to maintain shape; the nacelle being suspended by net of longitudinal canvas bands sewed to the envelope. Dirigibles having a long rigid framework nacelle suspended some distance below the envelope are usually included in the non-rigid class. The Beachy airship and army Dirigible No. 1 (1908) of several years ago are the best known non-rigid types in this country.

Military Observation Balloons

When a few years ago the aeroplane proved to be successful, and the attention of practically all students of aeronautics was drawn to its development for military purposes, interest in the captive balloon as a means of observation waned, not only in the United States, but abroad. In our case, the lack of sufficient appropriations for the aeronautical service of the army was also largely responsible for our failure to develop this valuable auxiliary.

The present war in Europe has demonstrated that the aeroplane, while of the greatest value for aerial reconnaissance, is not able to replace the captive balloon for certain purposes. So thousands of kite balloons are used in the pres-

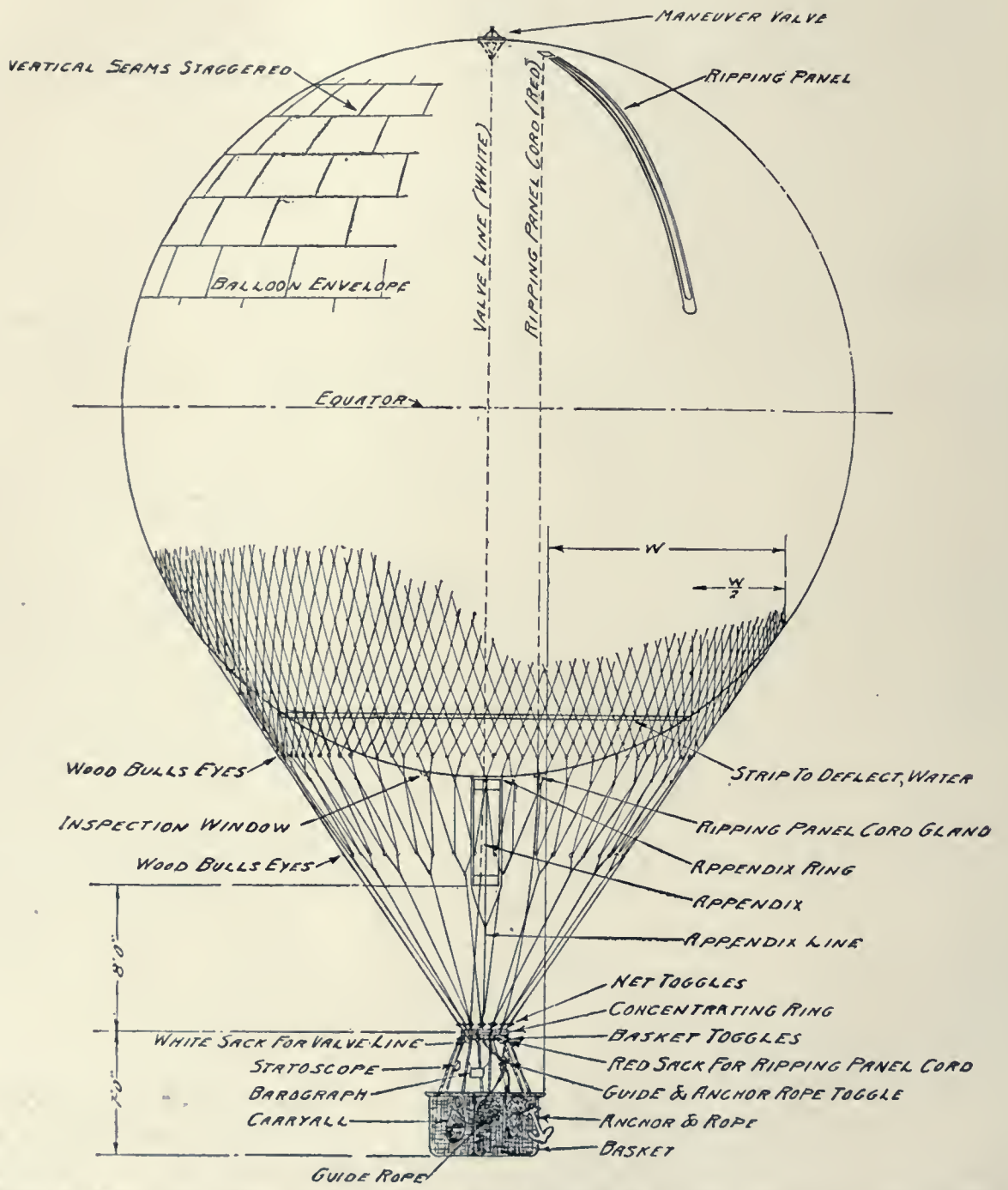

The Spherical Balloon—used mainly to train pilots for military observation balloons. The balloons range in size from 30,000 to 80,000 cubic feet.

ent war for directing artillery fire and observation.

The great advantage of the captive balloon is that the observer is constantly in direct telephonic communication with the artillery commanders in his vicinity; constant and thorough inspection of the enemy's positions with the aid of powerful glasses and telescopes reveals every movement of bodies of troops or anything new that has appeared during the previous night, and the targets thus presented can be immediately taken under fire. Continuous and searching observation of the same sector enables an observer to note even slight changes in the color of the earth and to make important deductions therefrom. Changes in trench construction can thus be easily detected.

One observer on the western battle front in France states that he was able to count twenty-six balloons in sight at one time; this is convincing testimony of their extensive use. It is an interesting development of the present war that battle type aeroplanes are assigned for the protection of the captive balloons and for this purpose cruise about at a height of several thousand feet above the balloon, ready to swoop down upon any enemy aeroplanes that attempt to destroy it.

Frequently, anti-aircraft guns are located sufficiently near balloons to maintain barrage fire over them to prevent hostile aeroplanes from approaching within range of their incendiary rockets or bullets.

The spherical type of captive balloon has been

abandoned in favor of the elongated type, often referred to as "sausage" or "drachen" (German for kite) balloon, since the latter type has much greater steadiness in the winds; the pressure of the moving air against the under side of the balloon holds it steady in the same manner as in the case of the common paper kite.

The kite balloon is fitted with a tail consisting of several conical canvas cups, to assist in maintaining its stability, with the same result as is secured by affixing a tail to the toy kite. The latest type of captive balloons are made with stream line shape and fins so that the kite tail-cups are not required for steadiness, and consequently should not properly be referred to as kites.

Employed at Night as Well as in the Daytime

In Europe the observation balloons are placed from two to four miles in rear of the line of trenches, and are separated by intervals depending upon the artillery activity in various sectors. The altitude at which they are held is dependent upon the atmospheric conditions and upon the distance of the enemy's artillery. They are usually sent up at daylight, and remain in the air until dark, being drawn down every few hours to change observers. Occasionally they remain up at night, and it is frequently found that enemy guns that are not visible by daylight may be located at night by their flashes. Even after dark it has been found that observers who have studied every feature of the ground for days are able to see

The winch for the kite-balloon mounted on a truck.

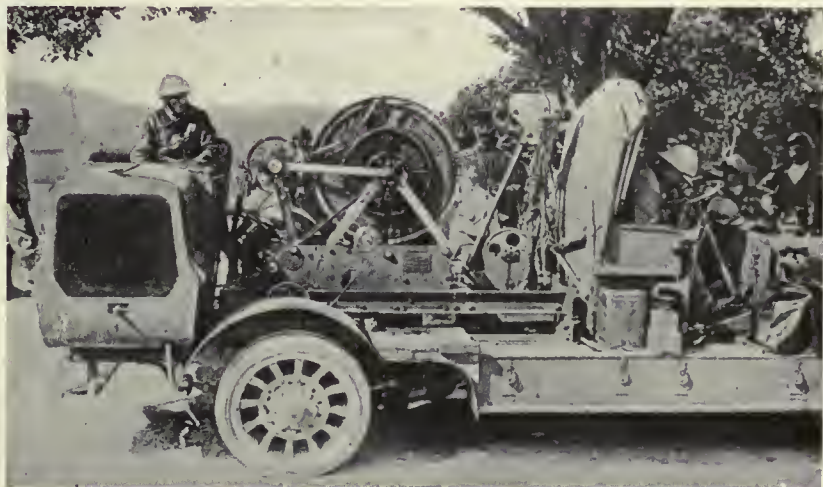



One of the new Cacquou type observation balloons used extensively by the Allies.

enough to fix accurately the position of the flashes. The strain of constant observation with high-power glasses, or telescopes makes it advisable to change the observers at frequent intervals.

It is customary to have two officers in the car of the balloon, and they are connected with the ground by telephone. One method is to have an insulated telephone wire in the center of the cable which holds the balloon; another method is to drop a strong, light-weight wire from the basket of the balloon to connect with the telephone circuits directly underneath. In both cases the steel wires of the holding cable serve to complete the electric circuit for the telephones.

Balloon companies are provided with telephone switchboards so that the observer in the basket can communicate directly with any bat-

tery or higher artillery commander in his vicinity.

Buildings, hills, or specially constructed towers concealed by the trees are frequently utilized in conjunction with captive balloons to provide an auxiliary observing station, so that the two may serve as the end stations of a base line for the accurate location of targets. In some cases another balloon is used as the second observing station.

For Directing Artillery Fire

It has been learned that at the beginning of the war various special codes of signals were experimented with for the purpose of enabling observers to report the error in the fall of shots, but these have been discontinued in favor of the brief announcement of "over," "short," "right," and "left." Field glasses having a milled scale permit of the observer reporting in degrees the distance of shots from the target.

For service with the mobile army it was customary in Europe before the war to have highly trained balloon companies, able to inflate a balloon and have it, with its observers, several thousand feet in the air in about twenty minutes after the organization had halted; this speed was attained by using compressed hydrogen carried in special vehicles.

Hydrogen Supply and the "Nurse"

The information of three or more years ago indicated that the peace strength of the balloon companies in Europe averaged about sixty men. The arduous and continuous service that has been required during the war has necessitated an increase in the number, there being at the present time in some cases 160 officers and men assigned to one balloon; this number provides for three reliefs for the captive balloon, the observation tower personnel, the telephone switchboard operators, and details for the manufacture of hydrogen.

Since the service along the western battle front has been in the nature of siege warfare, it has been practicable to supply hydrogen from portable field generators, instead of furnishing it compressed in cylinders.

The average capacity of the balloon is 32,000 cubic feet. There is continuous loss of hydrogen due to leakage through the fabric and to losses from expansion at high altitudes; these losses are ordinarily replaced at night. A common method of replacing gas is to fill small balloons called "nurses" at the nearest field generating plant; a small detachment of men can easily conduct this supply balloon to the hangar and transfer hydrogen from the "nurse" to the captive balloon as it may be required.

The Windlass

The most modern type of windlass for holding captive balloons consists of a winding drum constructed on a motor truck.

Whenever enemy aircraft attempt to destroy a captive balloon, it is customary to haul it down rapidly or to keep it moving around the field, to lessen the chances of its being hit. The moving is often done by using twenty-five or more men, each having a rope attached to a snatch block, through which the cable is passed. These men then walk to various points in the field, and their movement changes the position of the balloon not only horizontally but vertically as well.

Captive balloons are occasionally destroyed by incendiary bullets, arrows, or bombs dropped by aviators. Destruction in this manner is not

necessarily fatal to the observers, as they are usually provided with parachutes attached to body harness, which permit their safe descent to the ground.

About eight years ago, while Fort Omaha was garrisoned by signal corps troops only, a large balloon hangar was constructed at that point, together with a plant for generating hydrogen by the electrolysis of water and the machinery for compressing the gas. After its completion, the equipment was used for about two years for free and captive balloon instruction, but its employment for this purpose was later discontinued for the reasons previously stated.

The U. S. Army Balloon School is now established at Fort Omaha. Commissioned and enlisted personnel are assembled there, organized into companies and squadrons, provided with equipment and given considerable training before being sent out to serve the artillery and divisions.

Free Balloon Training Necessary

In case the cable holding a captive balloon should break, it then becomes necessary for the observer to descend and land in the same manner as in manœvering the ordinary free balloon, for which reason an essential part of the preliminary training of students at the Balloon School



One of the American Blimps manufactured by the Goodrich Company. (Passed by the Censor.)

TABLE FOR FINDING THE ASCENSIONAL FORCE OF GASES

The weight of air per 1000 cu. ft. at various temperatures and pressures may be found by inspection of this table.
 To find the weight of an equal volume of any gas, multiply the weight of air by the specific gravity of the gas. Hydrogen spec. grav. 0.0693 (pure).
 To find the ascensional force of any gas, subtract the weight of gas from the weight of air

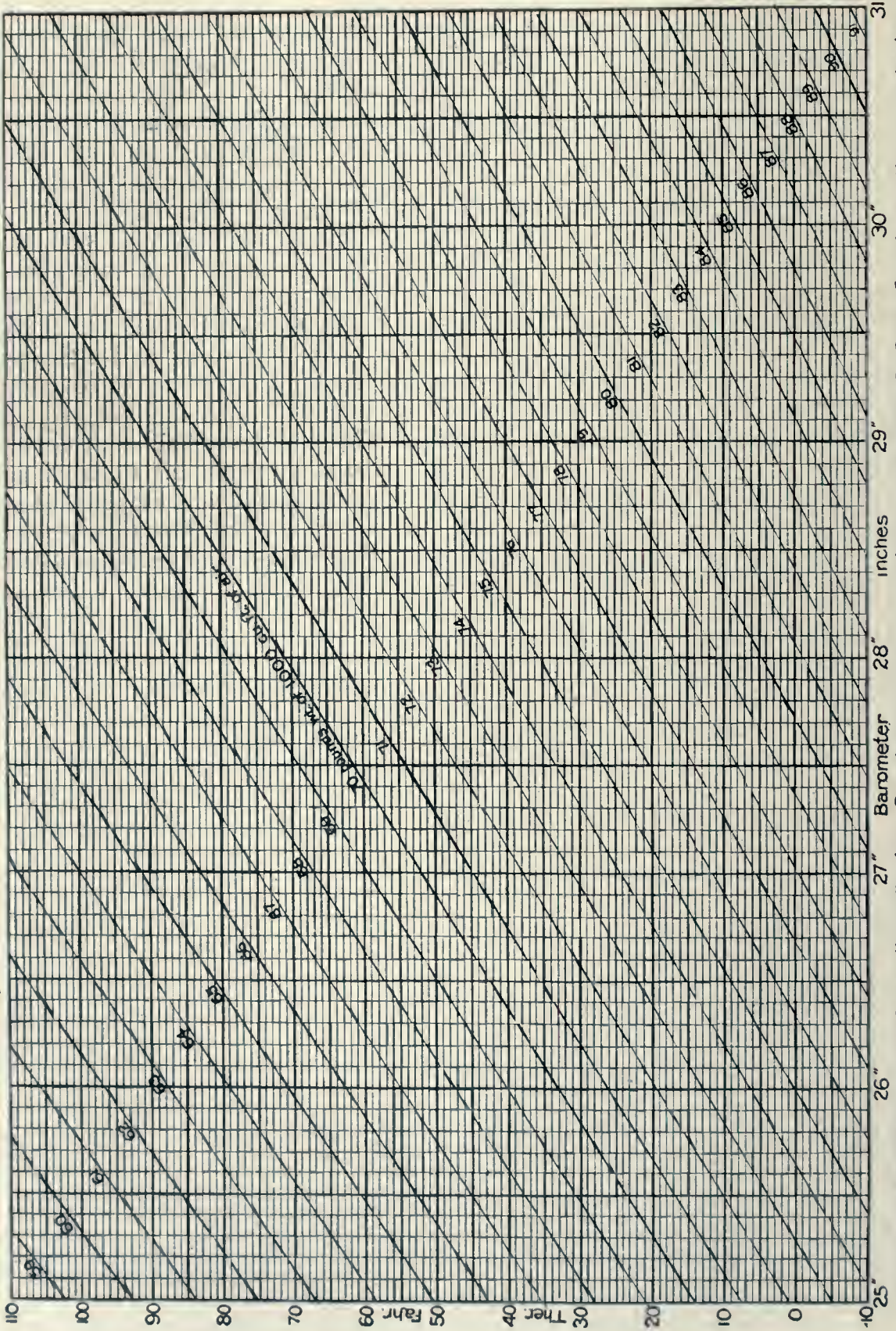

This table is sufficiently accurate for practical ballooning. For extreme accuracy corrections must be applied for force of gravity at latitude and elevation thermal expansion of brass scale and glass tube of thermometer and barometer and difference in coefficient of expansion of air and hydrogen
 C.D.F.C. 1906.

consists in the navigation of free balloons and qualifying as pilots thereof.

The Free Balloons

ITS CONSTRUCTION, INFLATION, AND OPERATION

The present war has brought out the value of free balloon training, and the sportsmen who took up ballooning as a sport in the past twelve years are now as valuable to the cause of national preparedness as if they had had military training for that same length of time.

A free balloon is the simplest of all aircraft. It is essentially a spherical bag made of silk, or cotton varnished or rubberized to prevent too rapid diffusion of the contained gas. Coal gas of light density (4) and hydrogen are the gases ordinarily used for the inflation of spherical balloons. A net is spread over the spherical gas envelope and by means of a loading ring the basket for passengers is attached to the lower terminal ropes of the net.

In the top of the envelope is a manœuvring valve the opening of which permits the escape of gas and consequent descent of the balloon. The valve cord, usually white in color, hangs vertically passing down through the appendix opening within reach of the pilot. When a free balloon lands in a wind it is necessary to deflate it very quickly in order to avoid being dragged along the ground; to provide for this a special ripping panel is made into the upper surface of the envelope, so arranged that when the pilot pulls the cord (colored red) attached to the upper end of this panel the stitching rips, thereby opening several feet of the gas bag and emptying all gas in a few seconds.

A free balloon usually is provided with a long guide rope and anchor (with separate rope). The navigating instruments consist of a recording barometer (baragraph) calibrated for altitude measurements, a statoscope, which is also a sensitive barometer and will indicate changes in altitude of only six or seven feet.

Synopsis of the Course of Training at United States Army Balloon School

The course of technical training is both practical and theoretical, so arranged that the prac-



One of the first kite-balloons used by the Aerostatic Section, U. S. Army at Omaha. (Photo passed by the censor.)

tical instruction will have preference at all times when weather conditions are suitable. Whenever high winds or rain interfere with the outdoor training the class room instruction is held and consists principally of conferences. The instructor covers the subject thoroughly and students are expected to ask questions and join freely in discussion. Practical instruction in the measurement of density of gases, testing and adjustment of instruments and similar laboratory indoor work is conducted when weather conditions outside are unfavorable.

PRACTICAL INSTRUCTION

- Generation and compression of hydrogen.
- Hydraulic testing of gas cylinders.
- Spreading envelopes and assembling parts of free and captive balloons.
- Inflation of balloons.
- Balancing free balloons.
- Use of ballast and balloon instruments while on voyages.
- Selection of landing spots and drag-ropeing.
- Deflation by valve and rip panel.
- Folding, packing, and shipment of balloons.

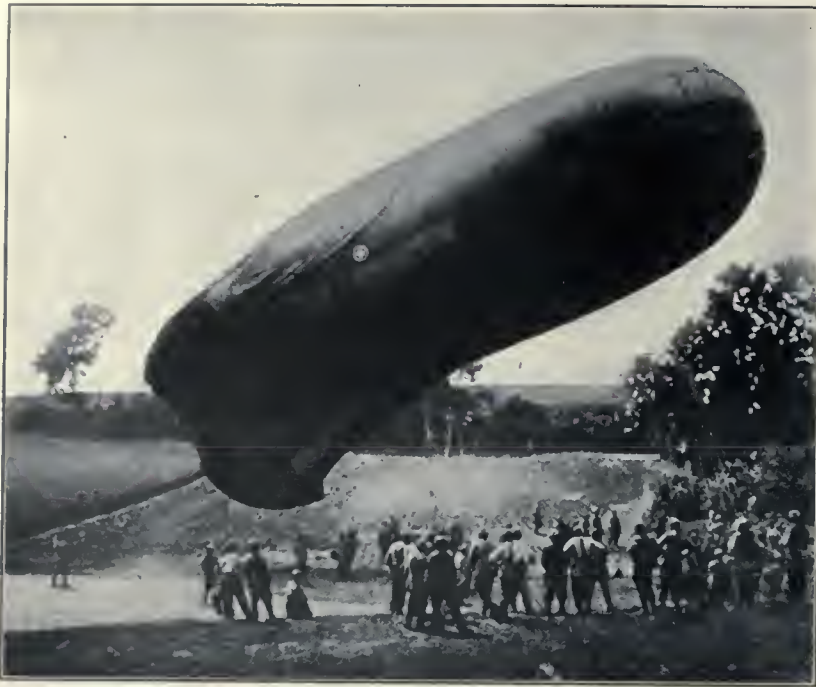

One of hundreds of Kite Balloons, which serve as the eyes of the artillery on all the fronts, being towed by its mooring-rope to its anchorage. There is a Kite Balloon for every heavy gun. An account of how Kite Balloons are operated for artillery was given in "Flying" for December.

Replacing of rip panel, repairs and inspection of envelope and net.

Qualification as balloon pilot according to F. A. I. rules.

Testing of cordage and fabric for breaking strength.

Testing of fabric for permeability to gases.

Practical handling of captive balloon windlass.

Filling kite balloons rapidly from cylinders of compressed hydrogen.

Motor truck operation and maintenance.

Determining course and position of free balloon by use of maps and compass.

CONFERENCES: ORGANIZATION, EQUIPMENT AND TRAINING OF BALLOON COMPANIES

Assignment of duties, commissioned and enlisted personnel.

Transportation and special technical vehicles.

Replacing gas lost by diffusion and expansion.

Replacement of empty hydrogen cylinders.

Field hydrogen generators.

Field compressing outfits.

Methods of observing and indicating targets and plotting shots.

Telephone service from balloons, instruments and circuits.

Photography and sketching from balloons.

Visual signal codes from balloons.

Property damage caused by descent in free balloons.

CONFERENCES: BALLOON CONSTRUCTION

Kinds of fabric suitable for balloons.

Preparation and application of varnishes for cotton balloons.

Cordage for nets and suspensions.

Shapes of balloon envelopes and standard sizes.

Strip and panel construction for envelopes.

Laying out patterns for envelopes.

Various types of seams.

Designs and tests of suspension patches.

Manufacture of nets.

Types and sizes of manœuvering valves and pressure valves.

Size, location, cord attachment and replacement of rip panel.

Appendix ring, neck and cord.

Kite balloon steering bags and substitutes.

Number, size and shape of tail cups.

Strength, weight, flexibility and construction of cable for captive balloons.

Sizes, types, weight and attachment of balloon ears.

Essential features of concentrating rings.

CONFERENCES: GASES

Kinds of gas suitable for free, captive and dirigible balloons.

Specific gravity of gases and methods of determining.

Manufacture of coal-gas and water-gas.

Production of hydrogen by electrolysis of water.

Hydrogen by steam and iron method.

Hydrogen by compression and refrigeration method.

Hydrogen by decarburation of oils.

Hydrogen by silicon-soda process.

Hydrogen from hydrogenite and hydrolythe.

Testing hydrogen for purity.

Compression of gases.

Flow of gases through pipes and orifices.

Types of gas-holders and their maintenance.

CONFERENCES: METEOROLOGY

Indicating and recording, barometers, thermometers, hygrometers and anemometers.

Tests, maintenance and method of mounting instruments.

Various changes in atmosphere with increasing altitude.

Movement of high and low pressure areas; direction and rate at various seasons.

Movement of atmosphere over large areas.

Local effect of vertical currents.

Cloud formations and deductions from them.

Weather maps, weather predictions; storm warnings and weather signal codes.

Tornadoes and cyclones; seasons and localities.

Average wind velocity in sections of the United States.

CONFERENCES: DIRIGIBLE BALLOONS

General types of rigid, semi-rigid and non-rigid balloons, and employment of each type.

Rigid dirigibles: Dimensions, shapes and materials used.

Semi-rigid: Dimensions, shape, materials, important structural features and methods of car suspension.

Non-rigid: Dimensions and shapes; main-



Drawing reproduced from the "Illustrated London News," showing the extent of the employment of observation balloons on the Somme front.

taining shape; material for envelopes; methods of car suspension.

Air resistance to various shapes and skin resistance.

Size and arrangement of ballonets.

Employment of ballast.

Vertical and horizontal stabilizing fins.

Rudders for altitude and direction.

Number and arrangement propellers.

Gasoline engines suitable for dirigibles.

Number and distribution and sizes of motors.

Gas engine principles and maintenance.

Dynamic reaction of atmosphere on under surface.

Velocity with respect to wind direction and earth.

Navigating instruments.

Hangars and methods of entry and exit in wind.

Designs for descending on water or land.

Bomb dropping devices.

Armament.

Memoranda:

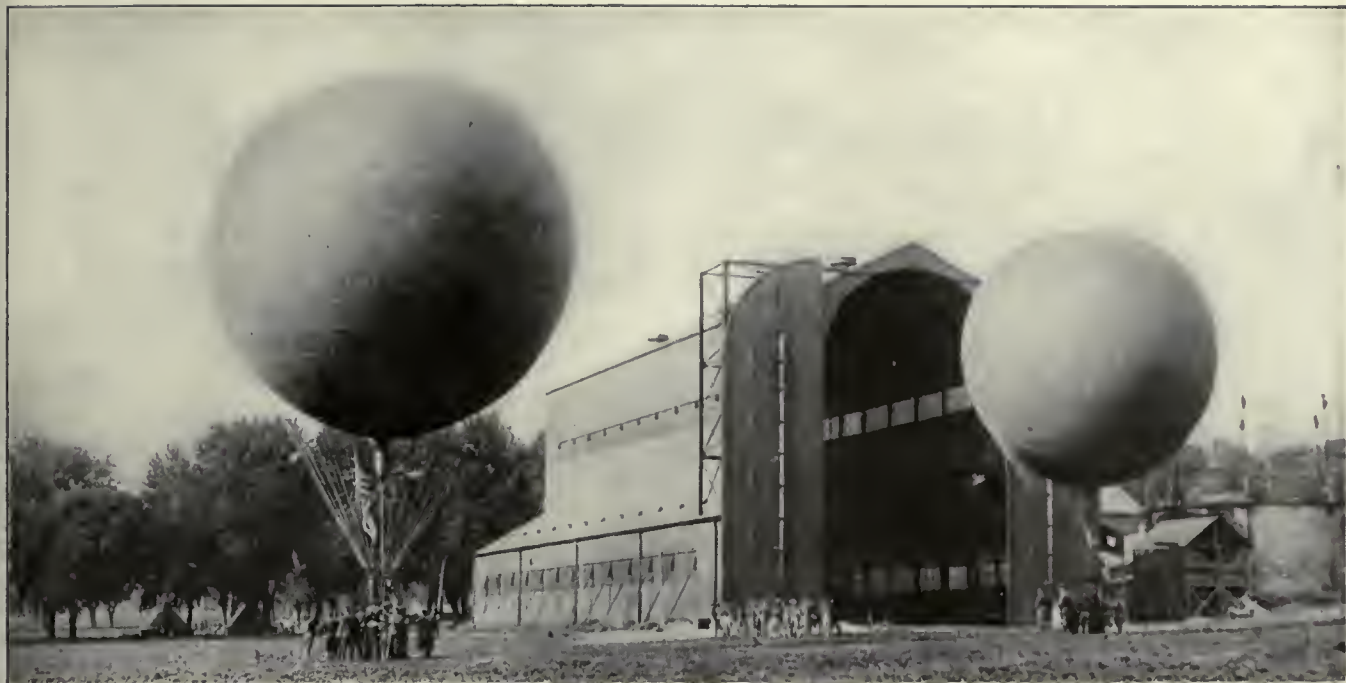

This photograph, passed by the censor, shows one of the hangars and some of the balloons at the U. S. Army Balloon School at Omaha, Nebraska. (International Photo.)

CHAPTER XIII

HYDROGEN FOR MILITARY PURPOSES

NOTES PREPARED BY LIEUT.-COLONEL C. DEF. CHANDLER, SIGNAL CORPS, U. S. A., FOR ARMY BALLOON SCHOOL

The production of hydrogen for commercial purposes has naturally been toward the development of methods which insure low cost, and the equipment designed is usually for permanent installations. Greatest efficiency in the production of hydrogen for the military service involves processes which permit of easily transportable generating equipment, ample available supplies of chemical substances, and purity of gas. It is often practicable for the army to use hydrogen plants of commercial types, shipping the gas compressed in cylinders, so that it is important that officers assigned to the lighter-than-air service become familiar with all practicable methods.

Properties of Hydrogen

Hydrogen is a colorless and odorless gas, when pure. Frequently in the manufacture of hydrogen by chemical processes impurities in

materials cause combinations of sulphur, carbon and arsenic, which with hydrogen even in minute quantities, produces an odor often incorrectly referred to as that of hydrogen.

Hydrogen is the lightest known gas, having a density of .0696, referred to air at the same pressure and temperature; this is equivalent to a weight of .005621 pounds per cubic foot at temperature of zero degrees C, and 76 cm. (.001476 grams per cubic centimeter, at zero degrees C. 76 cm.). 1 Gram (15.43 grains) at 0° C. 76 cm. equals 11.11 liters equivalent to 678 cubic inches of hydrogen. One grain of hydrogen at 60° F. and 30 inches barometric pressure equals 46.45 cubic inches.

Compared to other gases, hydrogen is absorbed very slightly in water. At 0° C., the absorption in water is .00192 and at 80 degrees C., the absorption is .00079 referring to weight in grams H₂ absorbed in 1000 grams of water. Hydrogen becomes liquid at a temperature of



A British airship about to ascend.

minus 220 degrees C. when subjected to a pressure of 20 atmospheres. No matter how low the temperature, the pressure must be at least 14 atmospheres, and, at this critical pressure, hydrogen liquefies at minus 240.8 C.

The coefficient of expansion of hydrogen due to temperature changes is .00366 per degree Centigrade at a pressure of 100 centimeters of mercury, and between the temperature of 1° and 100° Centigrade. This coefficient of expansion should be particularly noted for the reason that in less than 24 hours changes in temperature of 72° F. (40° C.) in the north temperate zone are not unusual. A lowering of the temperature 40° C. reduces the volume of gas nearly 15 per cent, causing a balloon of 25,000 cubic feet capacity to become flabby and have the appearance of losing 3200 cubic feet of gas.

Boyle's Law states that for a constant temperature the volume of gas diminishes in direct proportion to the pressure, but this applies only to ideal gases, of which there are none. The divergence of actual gases from Boyle's Law does not follow any formula; a curve plotted for any one gas is irregular at various pressures. (See

Smithsonian Physical Tables.) Hydrogen is less compressible than indicated by Boyle's Law, while nearly all other gases are more compressible. At normal temperatures and a pressure of 2000 pounds per sq. inch (136 atmospheres), the quantity of free hydrogen in commercial cylinders of 2640 cubic inches, should be, according to Boyle's Law, 208 cu. ft. whereas experiments show only 191 cu. ft. (Bureau of Standards.)

Hydrogen will burn in air when the percentage is as low as 4½, the flame traveling upward when ignited below. As the percentage of H₂ increases to 9, the flame will travel downward or in any direction. Further increases in percentage H₂ increase the intensity of the flame propagation, which when very rapid and violent is called an explosion. The flame propagation is increased when the hydrogen is mixed with oxygen not diluted with nitrogen as in air. Examples of this power and effect are occasionally observed when hydrogen and oxygen are accidentally compressed in the same cylinder.

Vitriol Process

One of the oldest and best known methods for hydrogen production is the vitriol process. The action of sulphuric acid on iron or zinc evolves hydrogen as shown by the following chemical equation:



It is essential that dilute acid be used for the reason that concentrated sulphuric acid forms a film of sulphate of iron on the surface, which is soluble in water but not dissolved by the concentrated acid. This process is so well known that a detailed description here seems unnecessary. The generating equipment can often be improvised by using substantial barrels or vats of wood or large glass or earthenware earboys, and lead pipes for conducting the acid. The caution to always pour the acid into the water and never the water into concentrated acid can not be repeated too often. Furthermore, when using improvised equipment or even specially constructed generators that are not positively gas tight, never strike a match or carry an open light such as a lantern near the generators.

It is found in practice that the washing and purifying of the gas by the usual methods does not entirely remove the water vapor carrying traces of sulphuric acid, which is most injurious to rubberized balloon fabrics; for this reason the vitriol process is not favored when it is practicable to secure hydrogen by other processes, but if it must be used then special precautions should be taken such as multiplying the number of washers and purifiers and frequently changing the lime in the purifiers. Fresh unslaked lime is used in the purifier to absorb the moisture charged with traces of sulphuric acid which passes out of the hot generating tanks. The lime (CaO) has a great affinity for water ($\text{CaO} + \text{H}_2\text{O} = \text{Ca}(\text{OH})_2$) changing it to slaked lime (calcium hydroxide) upon absorbing the water. The lime also combines chemically with the sulphuric acid forming calcium sulphate

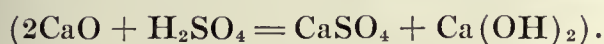

Greater purity of hydrogen can be insured when the weight of apparatus is unimportant, as in permanent installations, by adding in series more purifiers containing chemical substances such as Caustic Soda (NaOH) and Calcium Chloride (CaCl_2) both of which have property of absorbing moisture which is carried along with the hydrogen.

In order to determine the quantities of chemicals required to produce a certain quantity of hydrogen by any process, apply the atomic weights of the elements in the chemical equations in the manner shown below; for example,

making the object of the computation 1000 cu. ft. of hydrogen, it is necessary to determine first the number of cubic feet of hydrogen in one pound of the gas. This is found to be about 178 feet by taking 12,388 cu. ft. of air as weighing one pound and considering air as 14.4 times heavier than hydrogen, which figures are sufficiently accurate for this purpose.

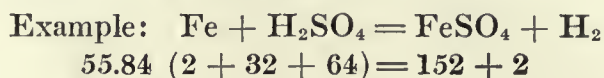

Then by Proportion:

$$\begin{aligned} 3256 \text{ cu. ft. H} : 1000 \text{ cu. ft.} &:: 55.84 \text{ lbs. Fe.} : X \\ X &= 157 \text{ lbs. iron} \end{aligned}$$

$$\begin{aligned} \text{Similarly for sulphuric acid, } 356 : 1000 &:: 98 X \\ X &= 275 \text{ lbs.} \end{aligned}$$

It is seen from the foregoing that 157 lbs. of iron and 275 lbs. sulphuric acid are theoretically required to produce 1000 cubic ft. hydrogen, but in estimating or purchasing these materials it is always advisable to increase the amounts by at least 5 and better 10 per cent. to allow for impurities in chemicals, incomplete chemical action, and losses of gas due to generators and pipes not being gas-tight in improvised apparatus.

The atomic weight of zinc is 65 and by a similar chemical equation it is found that theoretically 182.5 lbs. of zinc and 275 lbs. of sulphuric acid are required to produce 1000 cubic feet of hydrogen.



The motor transports, including hydrogen carriers of a U. S. Army balloon company photographed at Omaha. (Passed by the Censor.)



Portable hydrogen gas plant constructed for the chief engineering department of the Imperial Russian War Office.

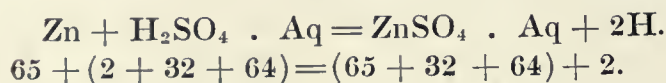

At least 5 per cent. should be estimated above the theoretical amounts, for supplies of zinc and acid. Zinc usually contains some lead as impurity; the lead is not objectionable, but on the contrary, is said to assist in promoting rapid chemical combination due to galvanic action.

Using only the quantities of iron and acid according to the theoretical computation and assuming the cost of iron turnings at 2 cents per pound and acid at 3 cents per pound, the cost of materials alone to produce 1000 cu. ft. hydrogen would be \$11.39.

Electrolytic Method

Hydrogen of greatest purity is obtained in commercial practice by the electrolysis of water, the hydrogen collecting on the negative electrode and the oxygen on the positive electrode where current enters the cell. A *direct current* of electricity is passed through water in a suitable cell which is provided with pipes for collecting both gases. The electro-chemical equivalent of hydrogen is .0000104 grams per coulomb which in larger units amounts to nearly 15 cubic feet of hydrogen for a current of 1000 ampere hours. The theoretical electromotive force required to dissociate water into its constituent elements is 1.47 volts between electrodes. Therefore, due to the internal resistance of the cell, if the voltage required is 2, then the computation shows that one kilowatt hour of

electric power will produce $7\frac{1}{2}$ cubic feet of hydrogen.

The internal resistance of cells increases with the distance between the electrodes, and decreases as the size of the electrode increases. It varies also depending upon the nature and specific gravity of the electrolyte in the cell.

Pure distilled water is a very poor conductor of electricity and extremely high E.M.F. would be necessary unless the conductivity is improved by adding suitable chemicals to the water. Ordinarily, pure caustic soda (NaOH) is used, bringing the solution to specific gravity between 1.2 and 1.25 at 60° F. It is found experimentally that $2\frac{1}{4}$ pounds of chemically pure caustic soda are required to bring one gallon of distilled water to 1.25 specific gravity. This is about 17 per cent. caustic soda and is the point at which the solution has the greatest conductivity. Adding more caustic soda increases the internal resistance. Caustic potash (KOH) may also be used for electrolyte but larger quantity is required and the present cost is much greater than that of caustic soda.

There are two general types of construction for electrolyzers, one being the unit type which consists of separate cells, each containing the positive and negative electrodes, connected electrically in series; the other general type being called by various names, "bi-polar," "multiple-plate," and "filter-press" types. These electrolyzers are usually constructed by assembling large plates very close together separating the positive and negative electrodes by sheets of asbestos; where 110 volt power is available these generators have 60 pairs of plates. The advantage of the multiple plate type over the unit cell type is principally lower first cost and less floor space required; the disadvantages being in greater maintenance cost and difficulty of preventing leakage of gas. Most of the electrolyzers made in the United States, both unit type and bi-polar, utilize a special weave of asbestos cloth as separator for the hydrogen and oxygen within the cell. The foreign-made cells at Fort Omaha have a very fine wire gauze to separate the gases.

The quantity of hydrogen produced by this method is proportional to the amperage passed

through the cell. For American made electrolyzers the current varies from 35 amperes to 1000 amperes, and for the Siemens cells at Fort Omaha the normal current is 1500 amperes. The E. M. F. required for each unit cell or for one pair of plates in the multiple type will average 2 volts, but depends entirely upon the internal resistance of the cell, which in turn depends upon the size of the electrodes, distance between them, nature and specific gravity of the electrolyte and the temperature. It is observed in practice that in starting the plant when cells are cold the E.M.F. per cell is often more than $3\frac{1}{2}$ volts, which reduces to less than 2 volts after the cells become hot.

As the water in the cells is converted into gas, it must be replaced by pure distilled water. The quantity being 5.76 gallons for 1000 cubic feet of hydrogen. It is seldom necessary to add caustic soda to the solution and then only enough to replace the very small quantity which is carried off from the cells by the moisture with the hot gases, but even this vapor may be condensed and recovered to some extent by moisture traps of various kinds.

Most manufacturers of electrolyzers in the United States claim an output of $7\frac{1}{2}$ cubic feet of hydrogen per kilowatt hour. As shown in the preceding paragraphs, this means an E. M. F. of not to exceed 2 volts per cell. When it is possible to secure electric power at 1 cent per

K. W. H. the cost of 1000 cubic feet of hydrogen for power alone is \$1.57 (assuming motor-generator efficiency of 85 per cent., and electrolyzer efficiency of $7\frac{1}{2}$ cubic feet hydrogen per K. W. H.).

The electrolytic plant installed by the army at Fort Omaha in 1908 consists of 30 large cells made by Siemens Bros. Company, Ltd., London, the normal current being 1500 amperes and the voltage varying from 4 to 2.2 per cell, depending on temperature. The temperature should be maintained at 150 degrees F. Higher than this is likely to damage the insulation and produce an excess of moisture with the gas. Lower temperature increases the internal resistance and cost of electric power. Each cell produces 23.3 cubic feet of hydrogen per hour, a total of 699 cubic feet per hour for the 30 cells, equivalent to 16,776 cubic feet per day of 24 hours for the plant.

Silicol Process

The production of hydrogen by dropping ferro-silicon into hot caustic soda is, in the French and British Armies, known as the "silicol" method; in Germany it is called the Schuckert process, and for many years the details of it were carefully concealed.

The chemical reaction producing hydrogen is between silicon and caustic soda without any

A battery of hydrogen gas cylinders attached to supply pipe of balloon being filled.

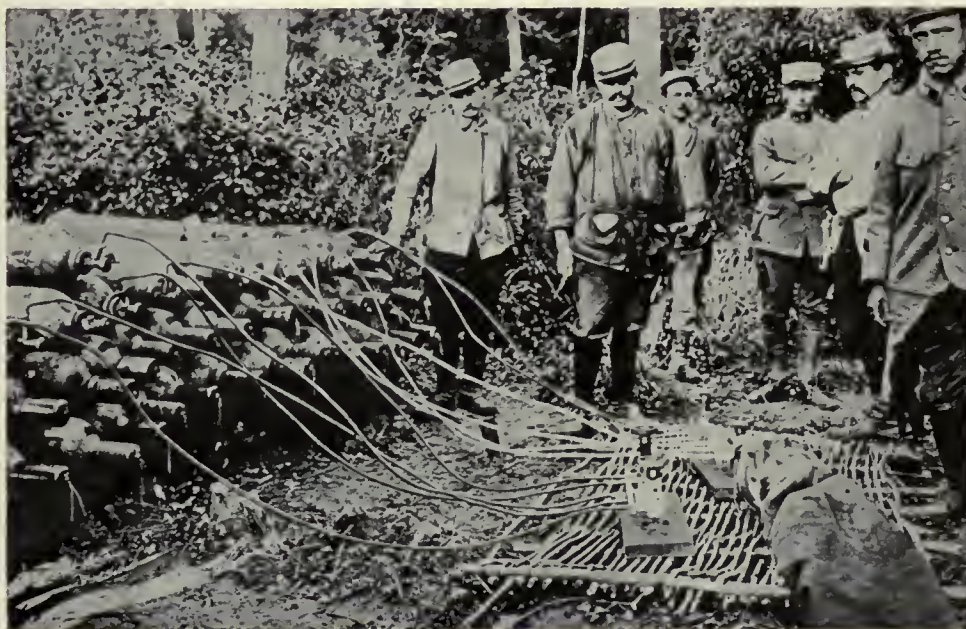

change in the iron. The following chemical equation will serve to explain the process: $\text{Si} + 2\text{NaOH} + 2\text{H}_2\text{O} = \text{Na}_2\text{SiO}_3 + 4\text{H} + \text{H}_2\text{O}$. In Germany it was customary to use pure or nearly pure silicon. In France this method was developed for the military service by Capt. Le Large and Dr. Jaubert; the generating apparatus being designed in three types; viz: Auto truck transportable size, semi-fixed and for permanent installations. Ferro-silicon is used, being more easily secured and at less cost than pure silicon as in the Schuckert generators. The steel industry in this country uses large quantities of ferro-silicon containing 50 to 75 per cent. silicon. Experiments have shown that more satisfactory chemical action is secured by having the silicon content 80 to 85 per cent. Commercial caustic soda of 97 per cent. NaOH is suitable.

Except in very cold weather the mixing of caustic soda with water produces sufficient heat to start the chemical combination of silicon and soda. It is necessary to agitate the solution constantly to secure best results and avoid sudden generation of large quantities of gas of explosive violence. The solution resulting from the chemical combination is sodium silicate, which may be easily drawn off at the bottom of the mixing tank.

According to the chemical equation, the production of one thousand cubic feet of hydrogen would require 39.6 pounds of pure silicon and 112.3 pounds of pure caustic soda. The actual quantities which should be supplied depend



German railway truck with steel cylinders.

upon the silicon content of the ferro-silicon and the percentage of purity of the caustic soda. An experiment conducted for the army determined that 58 pounds of 80 per cent. ferro-silicon and $125\frac{1}{2}$ pounds caustic soda would produce 1000 cubic feet hydrogen. Ferro-silicon at 15 cents per pound and caustic soda at 3 cents per pound would bring the total cost for materials to \$12.46 per 1000 cubic feet.

Ferro-silicon may be stored without deterioration by moisture and without any special precaution for its care. The caustic soda must be protected from moisture and is usually supplied in air-tight drums containing 100 pounds.

In connection with silicol generators, there are required washers and purifiers to remove from the gas the hot vapors carrying caustic soda solution. Field generators of this process should always be set up for operation near a stream or other ample supply of water. It is possible to design the generating equipment with radiators for cooling the circulating water for situations where water economy is important.

Iron Contact Process

The iron contact process for production of hydrogen is often referred to as the regenerative steam and iron and method, the principle being that when steam passes over red hot iron it is decomposed into its constituent elements, the iron absorbing oxygen from the steam and the hydrogen collected. The chemical reaction is represented by the equation: $2\text{Fe} + 3\text{H}_2\text{O} = \text{Fe}_2\text{O}_3 + 6\text{H}$. To utilize this principle commercially, it is necessary to reduce the ferric-oxide back again to metallic iron which can be done by passing carbon monoxide over the iron oxide, the carbon monoxide (CO) taking an atom of oxygen from the iron becomes carbon dioxide (CO₂) represented by the following equation:

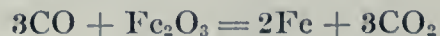

The commercial equipment for production of hydrogen by the iron contact process utilizes the well-known water-gas process for making the carbon monoxide which is needed to reduce the iron from the oxide to pure metallic state.

Close view of the carriage of a British Blimp.

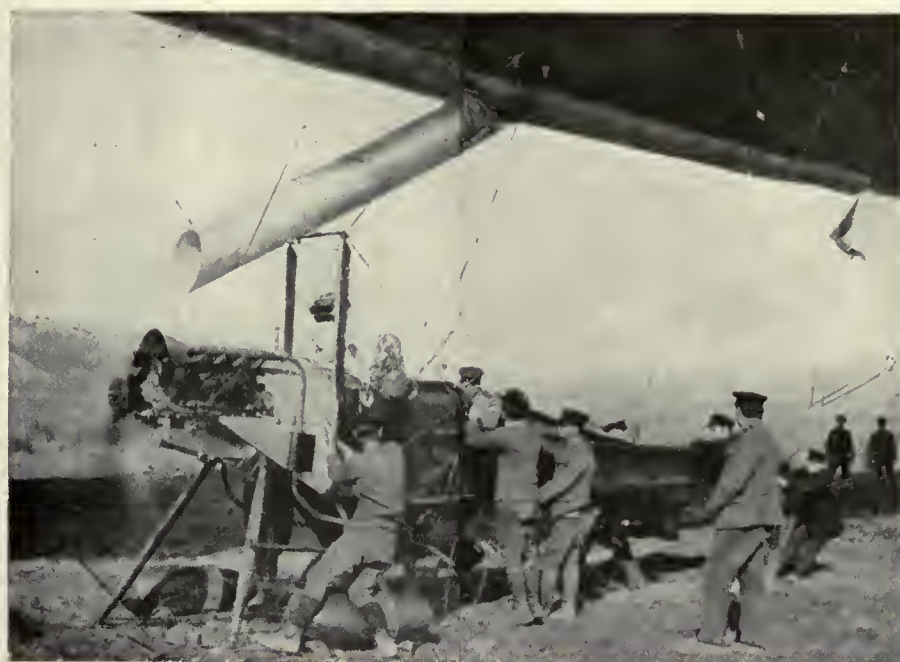

The water-gas generator is filled with coke which is heated to redness by a blast of air for a very brief period. When steam is turned on to this red hot coke, it is decomposed, the hydrogen freed from the oxygen is combined with the carbon of the coke forming carbon monoxide (CO). The water-gas consists principally of hydrogen and carbon monoxide, but must be passed through washers and purifiers to remove dust and particularly sulphuretted hydrogen. Sulphur is removed by passing the gas over trays of iron. The purified water-gas, usually referred to as "blue gas," is then stored in a holder, available for use as reducing agent.

After steam has passed over the red hot iron for a few minutes, the temperature is lowered to such an extent that it no longer decomposes the steam and it is then necessary to raise its heat and at the same time change the ferric oxide to metallic iron by turning the blue gas into the ovens. The period of heating the iron and reducing the oxide requires about twice the amount of time for the hydrogen production phase.

Temperature is a most important factor and must be constantly watched in all phases of the process. In the water-gas generator, if the temperature is too slow, carbon dioxide is formed instead of carbon monoxide. In reducing the ferric oxide, if the temperature is not

sufficiently high the reduction will be only from the ferric oxide Fe_2O_3 to Fe_3O_4 or at still lower temperature to FeO instead of to the pure metallic Fe.

The reduction ovens are originally filled with hematite (Fe_2O_3) which should be as porous as possible in order to expose greater surface to the action of the steam and carbon monoxide, and this ore should be free from sulphur compounds and other impurities. It is necessary to replace the ore in the ovens about every six months.

The iron contact process was developed long ago by Coutelle and perfected by Giffard in France, then developed commercially in England by Lane using several retorts for the iron. In Germany it was further developed by A. Messerschmitt, utilizing one large regenerative oven instead of many small retorts. The Messerschmitt regenerative oven is patented in the United States. The patents relate only to the oven and retorts; the steam and iron process is not patented. At least two firms in this country install iron contact plants, which produce 3500 cubic feet of hydrogen per hour. Plants of this size and type are now under construction for the Navy Department at Pensacola, for the Army at Langley Field, and for a private firm near Akron, Ohio.

Hydrogen produced by the iron contact proc-



Filling cylinders on the railway truck.

ess has a purity of at least 98 per cent. The impurities consist principally of nitrogen and carbon dioxide which have no deleterious effect on balloon fabric, nor are these gases inflammable. It is claimed that hydrogen can be produced by this process from 25 cents to 75 cents per thousand cubic feet.

Aluminum Caustic Soda Process

During the war between Russia and Japan both armies used field hydrogen generators employing the chemical reaction of alkaline hydrates upon aluminum. Sodium hydrate (NaOH) ordinarily known as caustic soda, is preferred to the potassium hydrate on account of the lower cost of the soda. The chemical reaction taking place is represented by the following equation:

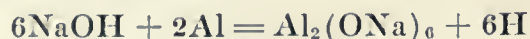

The generating apparatus was constructed in two types, one of small size installed on vehicles for rapid transportation, and a larger size called "semi-fixed." An iron basket is filled with aluminum scrap, lowered into the solution of caustic soda, the cover being immediately clamped to make it gas tight. The gas passes from the generator to a washing and cooling device which removes the traces of alkaline matter.

In the generator the aluminum is attacked by the soda solution with great energy, the gas coming off rapidly and the liquid heating to the

boiling point, but as the proportion of free soda in the solution diminishes, the rate becomes slower. In order to finish the gas production without delay, the generator is charged with caustic soda considerably above the theoretical requirement.

According to the theoretical computation, it is found that to produce 1000 cubic feet of hydrogen there are required 224 pounds of caustic soda and 51 pounds of aluminum. With caustic soda at 3 cents per pound and aluminum at 50 cents per pound, the cost of the one thousand cubic feet of hydrogen by this process is \$32.22. The actual quantity of materials to be carried will be considerably in excess of 275 pounds and the cost per thousand more than the foregoing computation indicates, on account of the necessity for using an excess of caustic soda and the fact that commercial caustic soda contains impurities, the most common grade containing only 77 per cent. sodium hydrate.

The aluminum and alkali method has the advantage of requiring about 20 per cent. less weight of material than the vitriol process and both materials being dry are easily transported without the especial care which is necessary for the transportation of sulphuric acid. Furthermore, the hydrogen produced is of greater purity, does not contain volatile hydrocarbons, nor the dangerous gases produced by combinations of hydrogen and arsenic.

U. S. patent was issued in September, 1901, for a modification of the aluminum-caustic-soda process. The inventor prepared the material by pouring molten caustic soda into a mass of aluminum in the form of powder, filings, or turnings, which was thoroughly mixed before the mass cooled. This mixture of material must be kept in sealed containers to avoid deterioration due to moisture in the atmosphere. When the mixed substance is placed in water the chemical reaction produces sodium aluminate and free hydrogen, probably according to the following equation:

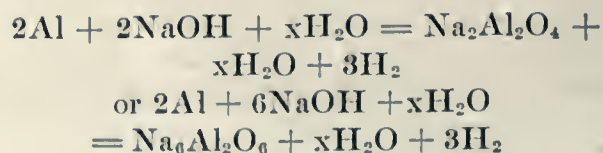

Hydrolithe

“Hydrolyte” is calcium hydride (CaH_2) manufactured by heating pure metallic calcium in retorts containing hydrogen. To produce hydrogen it is only necessary to drop the granulated hydrolyte into water. Generating equipment similar to the ordinary acetylene gas outfits are suitable. The reason hydrolyte is not more extensively used is on account of its high cost. About ten years ago the Signal Corps purchased a sufficient quantity to conduct experiments, which confirmed all claims for it, but chemical manufacturers in the United States do not produce it at present. It will be seen from the following chemical equations that only 59 pounds of hydrolyte are required to produce 1000 cubic feet of hydrogen:

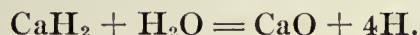

At 80 cents per pound for hydrolyte the cost of 1000 cubic feet of hydrogen by this method would be \$47.20.

Pure sodium or lithium dropped in water will produce hydrogen and it is possible to make hydrides of lithium the same as calcium which

will similarly produce hydrogen upon contact with water. On account of the light weight of lithium this would be particularly desirable for field hydrogen generation, and experiments are now in progress to determine whether it is practicable to manufacture lithium hydride at reasonable cost.

Dropping pure lithium in water would theoretically require only 40 pounds to produce 1000 cubic feet of hydrogen: $2\text{Li} + \text{H}_2\text{O} = \text{Li}_2\text{O} + 2\text{H}$.

And of lithium hydride $22\frac{1}{2}$ pounds would produce 1000 cubic feet hydrogen $2\text{LiH} + \text{H}_2\text{O} = \text{Li}_2\text{O} + 4\text{H}$.

About ten years ago an American manufacturer proposed the use of lead compounds having great affinity for water known as “Hydrone A, B, and C,” and experiments were conducted by the Signal Corps. It developed that the chemical reaction upon dropping the substance into an alkaline solution was so violent that the oxygen of the air above the generating tank would burn the hydrogen,—the ignition being due to heat of the chemical action. This difficulty was overcome by manufacturing a lower grade which evolved hydrogen slowly. The



One of the Goodyear “Blimps.” Photo passed by the Censor.



A military balloon ascending.

low-grade material was first dropped into the generator until the escaping gas had carried with it all oxygen above the water, then the high-grade substance was fed into the generator. On account of the extreme care that was necessary to avoid explosions with this method and the considerable weight of the hydrone, its further development for field hydrogen generation in the army was discontinued. One pound of hydrone produced only 2.88 cubic feet hydrogen at a cost of $6\frac{1}{2}$ cents per foot.

Hydrogenite

This hydrogen process is a modification of the "silicol" process already described. The chemical substances and reaction are the same as the silicol, but the materials are prepared and used in somewhat different manner. Pulverized ferro-silicon and caustic soda properly proportioned are thoroughly mixed and preserved in hermetically sealed cartridges, each containing 50 kilograms.

The field generators to use these cartridges consist of metal container slightly larger than

the cartridge, having a lid which can be clamped down gas tight. After placing the cartridge in the apparatus, the top of the can is opened and the mixed powders ignited. Around the inside of the cylindrical burning oven in which the cartridge is placed, is a trough to contain a measured quantity of water. The heat produced by the burning of the chemicals quickly converts this water into steam, the silicon, soda, and water combining as in the previously shown equation describing silicol method.

Ignition may be started by a fuse or taper inserted in the powder or by placing on top a small quantity of some easily combustible powder in order to produce sufficient heat in one spot to start the combustion. The hydrogenite burns rapidly and without flame, like tinder; a cartridge of 50 kilograms being consumed in about ten minutes.

When the mixture is first ignited, the air in the chamber and products of combustion are permitted to escape until the pure hydrogen appears. The gas is passed through washing and cooling purifiers before being used.

It is learned that even with the greatest care generators are frequently destroyed by explosions, for which reason the process is not in general use.

Hydrogen from Water-Gas

A German chemist developed and advocated some years ago the production of hydrogen for aeronautical purposes by first manufacturing water-gas in the usual manner, which consists principally of hydrogen and carbon monoxide, passing the water-gas over red hot calcium carbide in the form of powder. The hot calcium carbide decomposes the carbon monoxide forming lime (CaO) and leaving carbon in the form of crystalline graphite. The inventor claims that minor impurities in the water-gas are almost entirely removed in the reaction, producing hydrogen of 99 per cent. purity. The report further stated that generating equipment was devised to produce 70,000 cubic feet of hydrogen daily.

Hydrogen may also be separated from water-gas or coal gas by the fractional refrigeration

process. Hydrogen liquefies under pressure at lower temperature than other common gases, so that from illuminating gas having a considerable percentage of hydrogen it is possible to cool and compress it with liquid air apparatus, drawing off first all other gases as they liquefy and leaving the hydrogen. This method is not in general use for commercial production for the reason that other methods offer more simple and more economical means of securing hydrogen.

The Electrical Review (Vol. 40) reported that M. D'Arsonval passed coal gas previously cooled to minus 80° C. through a Linde liquid air machine, obtaining 3500 cubic feet of hydrogen per hour, expending 12 to 15 horse-power. Assuming coal gas to cost \$1 per thousand and containing 50 per cent. hydrogen, the cost of material would be about \$2 per thousand cubic feet hydrogen, to which must be added approximately 60 cents per thousand for power, plus cost of expert attendance.

Aluminum-Potassium Cyanide Process

A French chemist a few years ago advocated the generation of hydrogen for aeronautical

purposes by mixing aluminum filings with pulverized bichloride of mercury and potassium cyanide. After these ingredients are thoroughly mixed hydrogen will be produced by adding water. The powder has a density of 1.42 and must be kept in hermetically sealed cans. It is stated that experiments indicated 187 pounds of this material were required to produce 1000 cubic feet of hydrogen. The chemical reactions which take place should properly be represented by three or four stages, but may be sufficiently explained by the following single equation:

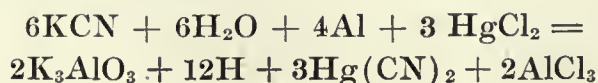

Acetylene Process

In 1901 Mr. H. Houbon, a resident of England; invented and patented a process for making pure hydrogen from acetylene. He compressed the acetylene to 5 atmospheres in a Caillet steel bomb and ignited it by electric spark. The carbon precipitates in the form of fine soot leaving the pure hydrogen. It is stated that the process is without danger and



A British "Blimp" passing over an anti-aircraft post.

calcium carbide for producing acetylene is very cheap, but it is not known that this process has ever been perfected for producing hydrogen in large quantities for aeronautical service.

By computation it is found that 180 pounds of calcium carbide are required to produce 1000 cubic feet of hydrogen by this method.

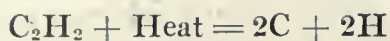

Iron and Water Process

Recently an article in a German technical journal described a new method for securing compressed hydrogen of great purity. So far as known it has been employed only in laboratories, but it may be developed later on a commercial scale.

Powdered iron is mixed in water in a vertical steel cylinder, the liquid being subjected to a pressure of 300 atmospheres (5,410 pounds per square inch) and the temperature raised to 350° C. The chemical reaction that takes place is sufficiently explained by the following equation:

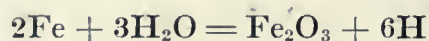

from which it is seen that under this great heat and pressure the iron combines with the oxygen from the water, and the hydrogen may be removed at the top of the cylinder already compressed for storage in cylinders. The iron oxide may be easily reduced again to metallic iron, which is facilitated by its porous condition, due to the peculiar manner in which it is oxidized. Hydrogen obtained is said to have 99 per cent. purity, which can be further increased to 99.95 per cent. by being passed over charcoal. When iron contains sulphur, the sulphur is not attacked, but any carbon content in the iron is converted into carbon monoxide.

Silico-Acetylene Process

The silicides of calcium, barium and strontium (CaSi_2 : BaSi_2 : SrSi_2) are made in the

electric furnace similar to the manufacture of calcium carbide. When calcium silicide is added to acidulated water, it is decomposed, leaving silico-acetylene in solution; the calcium oxide is precipitated. The solution is drawn off and evaporated, leaving yellow crystals of silico-acetylene Si_2H_2 . When these crystals are added to alkaline solution such as caustic soda or potash, the silico-acetylene is decomposed, evolving hydrogen. It is reported that 163 pounds of silico-acetylene are required to produce 1000 cubic feet of hydrogen.

Decarburation of Oils

About four years ago the *Scientific American* described equipment developed by the German Army for the generation of hydrogen by the method of decarburing hydro-carbon oils. The apparatus was designed for installation on two railway cars, the main part of the equipment consisting of two gas producers. To fire up these producers to the proper heat requires from one to two hours.

The producers are filled with coke which is heated to redness by air-blast. Crude petroleum or any petroleum distillates are first vaporized and then passed through the producer ovens containing the hot coke, which decomposes the oil. After about twenty minutes the coke has been reduced in temperature so much that it is necessary to heat it again to redness by hot air blast. This requires only two or three minutes.

The gas produced is passed through water scrubbers and purifiers to remove sulphur. It contains considerable carbon monoxide which is removed by passing the gas through an oven, the details of which process are not stated. The resultant gas is said to be 98.4 per cent. hydrogen, 1.2 per cent. nitrogen, and 0.4 per cent. carbon monoxide, and to have a specific gravity between 0.087 and 0.092.



Courtesy Underwood & Underwood. Photo passed by the Censor.
Group of students seated around big relief map.

CHAPTER XIV

TRAINING AVIATORS FOR THE UNITED STATES ARMY; HOME AND FOREIGN SERVICE

The training of aviators for the United States Army, for home and foreign service, is conducted by the Organization and Training Section of the Aviation Division, Signal Corps, whose offices are in the War Department, Washington, D. C.

According to a recently issued official statement, this Section deals with the organization of aviation school squadrons and standard aerosquadrons, the latter composed of graduated Reserve Military Aviators.

There are but a few officers with the title "Military Aviator" and "Junior Military Aviator." These are in administrative positions. Practically the entire new flying personnel is to be composed of Reserve Military Aviators.

This Section has nothing to do with training of men for aerostatic work, which is handled by the Balloon Division.

The Aviation Division of the Signal Corps is composed, originally, of officers and enlisted men of the Regular Army, limited by law to a definite number. Additional personnel is provided through the Signal Officers' Reserve Corps, the Signal Enlisted Reserve Corps, and the employment of civilians in instructive, advisory, administrative, or other capacities.

Civilians may be employed (1) as such; (2) by passing standard physical and mental examinations and by going through the routine of joining the Signal Officers' Reserve Corps, in which event, if satisfactory, they may be

given commissions therein commensurate in grade with their attainments and duties, as follows:

- (a) Non-flying duty,
- (b) Flying duty (as pilots or observers),
- (c) By enlistment in the Signal Enlisted Reserve Corps.

The Organization and Training Section also handles original applications for commissions in the S.O.R.C. from civilians. Regular Army or National Guard officers and men are needed as supply, engineer, or field-inspector officers. Opportunity is afforded by personal interview to obtain first-hand knowledge of the particular attainments of each man. If preliminary investigation is satisfactory, the applicant fills out his blank and is turned over to the Personnel Division, which attends to the routine of physical and mental examination. Upon the obtaining of his commission he is assigned to such place as his services are required.

Form of letter of application for examination for commission in Officers' Reserve Corps.

[Under section 37, Act of June 3, 1916.]

To _____,
_____,
_____.

SIR: I have the honor to apply for examination for a commission as ¹_____ aviation section, in the Signal Officers' Reserve Corps, organized under the authority of Congress.

¹ Insert grade, first lieutenant, captain, or major.

I have served _____ years in ²_____.

I have pursued a regular course of instruction for _____ years in ³_____.

I graduated in the year _____ from ⁴_____, after having creditably pursued the course of military instruction therein provided.

I was born _____, _____, at _____, and am ⁵_____ a citizen of the United States. Age _____. Color _____. Height _____. Weight _____.

My business is _____.

My experience is _____.

I inclose letters of recommendation and addresses of three citizens who know me as follows: _____.

Respectfully,

Permanent post office address _____.

The correctness of the statements above made was sworn to and subscribed before me _____, 19____.

⁶ _____
_____.

The duties of the Aero-Personnel Division consist of matters affecting the commissioned and enlisted men of the Aviation Section of the Signal Corps, which may be more conveniently termed the Army Air Service. All communi-

² Insert service in the Regular Army of the United States, or Volunteer forces of the United States, or Organized Militia of any State, Territory, or District of Columbia; also state in what capacity.

³ Insert name and location of the school or college.

⁴ Insert the name and location of the educational institution.

⁵ Insert "not" if in accordance with fact.

⁶ Oath to be taken before, and signature to be made by, officer authorized by law to administer oaths.



Group of army aviation students at one of the training fields.



Students learning the assembling of aeroplanes at a University, somewhere in America

cations to the Chief Signal Officer, or higher authority, that are concerned with the subject of aviation personnel must pass through this Division, except when such communications deal with civilian employees.

The personnel of the Army Air Service comprises the following groups:

(a) Enlisted men of the Regular Army.

(b) Signal Enlisted Reserve,¹ throughout this chapter referred to as "Enlisted Reserve Proper."

(c) Men (flying duty) enlisted temporarily in the Signal Enlisted Reserve in order to obtain training for a commission in the Aviation Section of the Signal Officers' Reserve Corps. (Throughout this chapter they are referred to as the "Enlisted Reserve.")

(d) Reserve Officers (flying duty).

(e) Reserve Officers (non-flying duty).

(f) Officers (of the Regular Army).

The Aero-Personnel Division is also concerned with two other groups of men:

(g) Enlisted applicants of the Regular Army for transfer to the Air Service.

(h) Commissioned applicants of the Regular Army for detail to the Air Service.

(a) Present provisions in regard to the first of these groups continue as now prescribed by law and Army Regulations. The Aero-Personnel Division has charge of the records of enlisted men of the Regular Army.

(b) The purpose of the "Enlisted Reserve Proper" has been to secure a body of trained

mechanicians, machinists, electricians, chauffeurs, and other qualified men, who may be quickly called in time of need. Cards giving the home addresses and information about the enlistments of such reservists are kept in the Aero-Personnel Division. Similar information is in the service record of each reservist, in the hands of the department commander in whose territorial jurisdiction he resides. No more enlistments in this group as reservists are being made at present, there being no desirability during wartime to increase the number of reserves not on active duty. At date of writing the entire personnel of this group is being called into active service by department commanders immediately upon enlistment. They are assigned to aviation stations and placed in training.

(c) The enlisted reservists who are applicants for commissions as reserve officers, flying duty, and are enlisted in the Signal Enlisted Reserve Corps simply for the purpose of preliminary training prior to receiving their commissions, comprise an extremely important group. From their number will come almost exclusively the aviators of the Army Air Service. The procedure in regard to the enlistment of these men is in the hands of the Aero-Personnel Division. All applicants for commission in the Aviation Section of the Signal Officers' Reserve Corps must forward their applications to the Aero-Personnel Division for approval or disapproval. If the application is approved, its sender is given an examination to determine his physical condition, and a second examination to test his moral, professional, and educational

¹ Inasmuch as all enlistments are for the period of the war and the policy of the office is to accept men for the Regular Army only, paragraph (b) is modified to this extent.



America's future airmen are here shown practicing the Morse International Code as one of the first steps in mastering the science of radio transmission which they will soon be using over the German trenches in France. Photo passed by Censor.

qualifications for a commission. Boards to give the complete examinations are situated at each of the Schools of Military Aeronautics; also at the several Signal Corps flying schools in the different states and at Washington.

If the candidate is successful in passing these examinations, he is reexamined with a view to enlistment as first-class private in the Signal Enlisted Reserve, and is then either sent home with a certificate of enlistment to await further orders, or is sent immediately to one of the "ground schools" (Schools of Military Aeronautics) for instruction.

From this time until the receipt of his commission the candidate is under the jurisdiction of: First, the Schools of Military Aeronautics Division; and later the Organization and Training Division. The Aero-Personnel Division asks for the transfer to the "ground schools" of suitable students on duty at the Federal Reserve Officers' Training Camps. Such requests, if recommended, are made weekly.

(d) Upon successful completion of the flying-school course, the candidate is commissioned as a reserve officer, whereupon his relation to the Aero-Personnel Division becomes like that of a regular officer of the Air Service.

Competent civilian flyers, who pass the physical and mental examinations and are satisfactory otherwise, may at once be commissioned in the Signal Officers' Reserve Corps and ordered to active duty.

(e) Civilian applicants for commissions in the S. O. R. C. for non-flying duty in capacities such as engineer, supply or other officer, may take mental and physical examinations (the latter less rigid than that for flying duty), and if qualifications are satisfactory, may be commissioned and ordered to active duty.

(f) All communications in regard to officers of the Army Air Service pass through the Aero-Personnel Division. Similarly, all orders for officers of the Air Service that are requested from the Adjutant-General pass through this division. Complete military records of officers are also kept there.

(g) Applications of enlisted men of the Signal Corps proper, or of other staff corps or departments or arms, for transfer to the Air Service should be approved by the Aero-Personnel Division before orders are issued for such transfer.

(h) Any officer of the Regular Army, who is an applicant for detail to the Air Service, has his military record and correspondence concerning him kept by the Aero-Personnel Division while he is undergoing training at the Signal Corps flying schools. Upon detail to the Air Service, the status of such an officer in relation to this division is precisely like that of other officers of the Army Air Service.

In all cases application for enlistment, transfer, detail, or commission, is made direct to the Aero-Personnel Division.

Schools of Military Aeronautics (Ground Schools)

Successful candidates for flying duty are directed by the Aero-Personnel Division to one of the ground schools located at the following institutions:

Massachusetts Institute of Technology, Boston, Mass.

Cornell University, Ithaca, New York.

Ohio State University, Columbus, Ohio.

University of Illinois, Urbana, Illinois.

Texas University, Austin, Texas.



One of the Army aviation training fields, showing Curtiss JN-4 school planes. (Committee on Public Information.)

University of California, Berkeley, Calif.

Princeton University, Princeton, N. J.

Georgia Institute of Technology, Atlanta, Ga., John Hopkins University, etc.

(Additional institutions are being added to this list at date of writing.)

Upon arrival, the S. M. A. Division is advised thereof, with a list of candidates, which list is kept by the S. M. A. Division in coöperation with the Organization and Training Section. Now the students are under the charge of the S. M. A. Division.

Here the students serve eight weeks with the pay of a first-class private, about a dollar a day, and with the allowance of a dollar a day for rations. Quarters are provided in barracks. The candidate upon entering the Ground Schools of Military Aeronautics becomes a cadet. He is assigned to a "Junior Squadron," where he remains for three weeks; then he is transferred to a "Senior Squadron."

Each squadron consists of between twenty to thirty cadets in charge of a first sergeant.

At these ground schools the cadets are given a general course in military discipline and drill, as well as intensive instruction in aeronautical engines, telegraphy, machine-guns, bombing and fighting, aerial observation and coöperation with artillery and infantry, including map-reading, contact patrol and reconnaissance; army regulations and military subjects; flying with meteorology, instruments, compasses, photography; rigging, care and repair of aeroplanes, engines and cameras. Guns and other apparatus are provided for practical study.

Upon completion of this course the students are assigned through the Aero-Personnel Division to the aviation school squadrons, as noted under "Organization and Training."

The daily schedule at the ground schools of military aeronautics is more or less as follows:

Reveille, 5:35 A. M. First call, 5:40. All calls are by bugles, the same as in the army. Assembly is blown at 5:50 A. M., when all cadets must be in ranks in their respective places. On all assembly calls the first sergeant of each squadron orders his men to fall in. Then he receives his corporal's report of "lates" or "absentees," about faces to the officer of the day, and reports concerning lates or absentees from his squadron; whereupon the officer of the day commands the senior first sergeant or cadet captain to take charge of the men for calisthenics.

The senior cadet sergeant marches all the squadrons to the court, and when they have taken their respective places leads them through ten minutes of calisthenics. At the end of this time the squadrons are placed in command of their respective sergeants, the two senior squadrons being marched immediately to mess, the remaining squadrons returning to the quadrangle, awaiting their turn for mess.

The mess takes about an hour for each squadron. At 6:55 A. M. first call for drill is blown. At 7 A. M. assembly is blown, whereupon the men are marched to the drill field and given one hour of military drill. As the men in this school are training to become aviator officers, a full course in military drill is not required, the reason being that the man getting his commis-

sion will have hardly any enlisted men under him to drill.

The work after drill is different for different wings of the school. The first three weeks, or Junior Wing, and the last five weeks, or Senior Wing, have the following schedules:

FIRST THREE WEEKS JUNIOR WING		LAST FIVE WEEKS SENIOR WING	
7- 8 A. M.	Drill	7- 8 A. M.	Drill
8- 9 "	Class	8- 9 "	Class
9-10 "	Drill	9-10 "	Class
10-11 "	Class	10-11 "	Class
11-12 "	Calisthenics	11-12 "	Class
12	M. Mess	12	M. Mess
2- 3 P. M.	Drill	2- 3 P. M.	Class
3- 4 "	Calisthenics	3- 4 "	Class
4- 5 "	Drill	4- 5 "	Calisthenics
5:45 P. M.		First Call	
5:50 "		Retreat	
5:55 "		Assembly	
	March to mess		
7:55 P. M.		School Call	
8:55 "		Dismissed or Recall	
9:10 "		Tattoo	
9:15 "		Roll Call in barracks	
9:30 "		In bed—and lights out	

Every Saturday morning between 7 and 8 inspection of the entire student company is held under arms on the drill field, and is followed by inspection of barracks by the commandant.

Instruction in the Junior Wing

Instruction in the Junior Wing consists of elementary work in wireless, such as sending and receiving, machine-gun instruction and machine-gun theory.

Instruction in the Senior Wing

Instruction for the first week in the Senior Wing is as follows:

MONDAY:	7- 8 A. M.	Drill
	8-10 "	Wireless
	10-12 "	Gas-engines
TUESDAY:	2- 3:50 P. M.	Machine-guns
	8- 9 A. M.	Lecture, Type of Machine
	9-10 "	Lecture, Bombs and Bombing
WEDNESDAY:	10-11 "	Lecture, Wireless
	11-12 "	Lecture, Theory of Flight
	2- 3:30 P. M.	Lecture, Gasoline Engines
THURSDAY:	8- 9 A. M.	Theory of Wireless
	9-10 "	Nomenclature
	10-11 "	Reconnaissance
FRIDAY:	11-12 "	Map-Reading
	2- 3:30 P. M.	Gas-engines
	8- 9 A. M.	Nomenclature
TUESDAY:	9-10 "	Study Hour
	10-11 "	Bombs and Bombing
	11-12 "	Machine-guns
WEDNESDAY:	2- 2:50 P. M.	Wireless
	3- 3:50 "	Theory of Wireless
	8- 9 A. M.	Study Hour
THURSDAY:	9-10 "	Art of Observation
	10-11 "	Theory of Wireless
	11-12 "	Machine-guns
FRIDAY:	2- 3:50 P. M.	Gasoline engines

SATURDAY:	8- 9 A. M.	Study Hour
	9-10 "	Reconnaissance
	10-11 "	Map-Reading
	11-12 "	Art of Observation

For the second week it is as follows:

MONDAY:	8- 9 A. M.	Study Hour
	9-10 "	Art of Observation
	10-11 "	Map-Reading
	11-12 "	Nomenclature
TUESDAY:	2- 3:50 P. M.	Miniature range
	8- 9 A. M.	Machine-guns
	9-10 "	Study Hour
	10-12 "	Gasoline engines
WEDNESDAY:	2- 2:50 P. M.	Art of Observation
	3- 3:50 "	Instruments, including Compasses
	8- 9 A. M.	Study Hour
	9-10 "	Reconnaissance
THURSDAY:	10-12 "	Gasoline engines
	2- 3:50 P. M.	Miniature range
	8-11 A. M.	Rigging and Landing Gear
	11-12 "	Study Hour
FRIDAY:	2- 3:50 P. M.	Gasoline engines
	8- 9 A. M.	Tools
	9-10 "	Study Hour
	10-11 "	Machine-guns
SATURDAY:	11-12 "	Art of Observation
	2- 3:50 P. M.	Gasoline engines
	8- 9 A. M.	Study Hour
	9-10 "	Instruments, including Compasses
FRIDAY:	10-11 "	Wireless
	11-12 "	Reconnaissance

During the third week it is as follows:

MONDAY:	8-10 A. M.	Gasoline engines
	10-12 "	Machine-gun test
	2- 3 P. M.	Instruments, including Compasses
TUESDAY:	3- 4 "	Study Hour
	8- 9 A. M.	Theory of Wireless
	9-10 "	Lecture on Photography
WEDNESDAY:	10-11 "	Machine-guns
	11-12 "	Study Hour
	2- 3:50 P. M.	Miniature range
THURSDAY:	8- 9 A. M.	Study Hour
	9-10 "	Instruments, including Compasses
	10-11 "	Contact patrol
FRIDAY:	11-12 "	Tools
	2- 3:50 P. M.	Miniature range
	8- 9 A. M.	Study Hour
SATURDAY:	9-12 "	Rigging and Landing Gear
	2- 3 P. M.	Signal Instruction
	3- 4 "	Map-reading
SATURDAY:	8- 9 A. M.	Buzzer Practice
	9-10 "	Machine-guns
FRIDAY:	10-12 "	Bombs and Bombing

For the fourth week it is as follows:

MONDAY:	8- 9 A. M.	Study Hour
	9-12 "	Rigging and Landing Gear
	2- 3:50 P. M.	Gasoline engines
TUESDAY:	8- 9 A. M.	Study Hour
	9-10 "	Machine-guns
	10-12 "	Miniature range
WEDNESDAY:	2- 3:50 P. M.	Gasoline engines
	8-10 A. M.	Gasoline engines
	10-11 "	Meteorology
THURSDAY:	11-12 "	Photography
	2- 3 P. M.	Radio and Wireless
	3- 4 "	Signal telegraphy
FRIDAY:	8- 9 A. M.	Theory of Wireless
	9-10 "	Theory of Sending and Receiving



Lieutenant Montariol, French Flying Corps, instructing a class of aviation students somewhere in America.

THURSDAY:	10-12	A. M.	Examination in theory of Sending and Receiving Wireless
	2- 3	P. M.	Machine-guns
	3- 4	"	Instruction in Wigwag and Semaphore
FRIDAY:	8-10	A. M.	Gasoline Engines
	10-12	"	Examination in the Theory of Flight
SATURDAY:	2- 4	P. M.	Machine-guns
	8-10	A. M.	Gasoline Engines
SATURDAY:	10-12	"	Examination in Gunnery, including bombs and bombing, and machine-guns
	For the fifth week:		
MONDAY:	8- 9	A. M.	Examination in Wigwag and Semaphore
	9-12	"	Work in the field with a field wireless set, as used by the United States Army in the field
TUESDAY:	2- 4	P. M.	Study Hour
	8-11	A. M.	Sail-making and Rope-splicing
	11-12	"	Study Hour
	2- 3:50	P. M.	Examination on the theory of Gasoline Engines
WEDNESDAY:	8- 9	A. M.	Study Hour
	9-10	"	Lecture on Magnetos
	10-11	"	Signal Telegraphy
	11-12	"	Meteorology
THURSDAY:	2- 3:50	P. M.	Care of machine
	8-10	A. M.	Rotary gasoline engines
	10-12	"	Miniature range examination
	2- 3:50	P. M.	Transportation of machines. Verbal examination on motor-trucks
FRIDAY:	8-10	A. M.	Aerial observation, which consists of fighting in the air, reconnaissance and map-reading
	10-12	"	Engines
SATURDAY:	7- 8	A. M.	Inspection

the Aero-Personnel Division in cooperation with the O. & T. Section, to the various aviation school squadrons for instruction in actual flying. From this point on the flying students are in charge of the O. & T. Section.

Following is a list of the location of aviation school squadrons organized and to be organized in the near future. As time goes on, doubtless this schedule will be extended.

Mineola, N. Y.—Operating.

Mt. Clemens, Mich. (Selfridge Field).—Operating.

Fairfield, O. (Wilbur Wright Field).—Operating.

Rantoul, Ill. (Chanute Field).—Operating.
So. Mississippi Valley.—Under investigation.

San Antonio, Tex.—Operating.

San Diego, Calif.—Now operating.

Belleville, Ill.—Operating.

One station to be in Rocky Mountain Region.

Fort Sill, Okla. (advanced school operating).

At the above schools training is done with as much rapidity as possible. At the conclusion of from fifteen to twenty-five hours' flying, it is expected students will be able to pass tests for certificates as Reserve Military Aviators.

While undergoing this flying instruction, the

Training at Army Aviation Schools

Graduates of the Schools of Military Aeronautics (ground schools) are assigned through



Training America's first thousand aviators. The photo shows three training aeroplanes in the air at one of the training fields.

pupil is required to study radio, gunnery, photography, motors and aeronautical engineering. This study is practical; the student handles and operates every instrument, assembling and disassembling engines, and does construction and repair of aeroplanes to the extent that he must assemble, disassemble, line-up, etc. In the gunnery instruction, for instance, the student uses a machine in which a gun is mounted and is given target practice at objects moving in the air.

Upon receiving their certificate, these flying students are commissioned as First Lieutenants, Signal Officers' Reserve Corps, Aviation Section, and when on duty involving frequent or continuous flying, receive twenty-five per cent. increase in pay. The base pay is \$2,000 a year. When on foreign duty ten per cent. increase on the base pay is allowed. Quarters are also furnished.

Standard aero-squadrons of the army are formed at the aviation school squadrons. The flying and enlisted personnel for these squadrons is furnished from these flying schools. The officers, of course, are Reserve Military Aviators by this time, though some may be Junior Military Aviators. The enlisted men

are of the Enlisted Reserve Corps, or of the Regular Army.

These aero-squadrons, thus formed, will be fully equipped, save as to aeroplanes, and transported to England or France for advanced training.

These graduated aviators (R. M. A.'s) may also be sent to complete the complement of aero-squadrons already in process of formation or partially filled, to be maintained at certain points.

Tests for an Aviator's Certificate

In different stages of training the student or military aviator may go through tests and obtain the following certificates:

(1) *The F. A. I. Certificate.* This is the international certificate issued under the rules of the International Aeronautic Federation by the Aero Club of America. It represents the federation in the United States and in other countries on the American continent which do not have a national aero club affiliated with the International Aeronautic Federation.

It is necessary to have this certificate to enter aeronautic meets, and to have records homologated.

gated and accepted by the International Aeronautic Federation.

Following are the rules under which F. A. I. certificates are granted by the Aero Club of America:

1. A person desiring a pilot's certificate must apply in writing to the Secretary of the Aero Club of America. He must state in his letter the date and place of his birth, and enclose therein two unmounted photographs of himself about $2\frac{1}{4} \times 2\frac{1}{2}$ inches, together with a fee of five dollars. In case the applicant is a naturalized citizen of the United States he must submit proof of naturalization.

2. On receipt of an application the Secretary will forward it promptly to the Contest Committee, which, in case of an application for an aviator's certificate, will designate a representative to supervise the test prescribed by the International Aeronautical Federation, and will advise the representative of the name and location of the applicant and, through the Secretary, advise the applicant of the appointment of the representative to take the test.

3. In case the application is for a spherical balloon or for a dirigible balloon pilot's certificate the applicant will be fully advised by the Contest Committee.

4. All applications for aviator's certificates must reach the Secretary a reasonable time in

advance of the date that the applicant may expect to take the required test.

5. No telegraphic applications for certificates will be considered.

Applicants for each class of certificate must be of the age of 18 years, and in the case of dirigible certificates 21 years, and must pass, to the satisfaction of the properly designated representatives of the Aero Club, the tests prescribed by the F. A. I., as follows:

Spherical Balloon Pilot's Certificate

Candidates must pass the following tests:

- (A) Five ascensions without any conditions.
- (B) An ascension of one hour's minimum duration undertaken by the candidate alone.
- (C) A night ascension of two hours' minimum duration, comprised between the setting and the rising of the sun.

The issue of a certificate is always optional.

Dirigible Balloon Pilot's Certificate

Candidates must be 21 years of age.

They must hold a spherical balloon pilot's certificate and furnish proof of having made twenty (20) flights in a dirigible balloon at different dates.

They must also undergo a technical examination.



A group of aviation students at one of the army training fields.

In case, however, the candidate does not already possess a spherical balloon certificate, he must have made twenty-five (25) ascensions in dirigibles before he can apply for a certificate.

The application for the certificate must be countersigned by two dirigible balloon pilots, who have been present at at least three of the departures and landings of the candidate.

The issue of the certificate is always optional.

Aviator's Certificate

1. Candidates must accomplish the three following tests, each being a separate flight:

A and B. Two distance flights, consisting of at least 5 kilometers (16,404 feet) each in a closed circuit, without touching the ground or water, the distance to be measured as described below.

C. One altitude flight, during which a height of at least 100 meters (328 feet) above the point of departure must be attained; the descent to be made from that height with the motor cut off. A barograph must be carried on the aeroplane in the altitude flight. The landing must be made in view of the observers, without restarting the motor.

2. The candidate must be alone in the aircraft during the three tests.

3. Starting from and landing on the water is only permitted in one of the tests A and B.

4. The course on which the aviator accom-

plishes tests A and B must be marked out by two posts or buoys situated not more than 500 meters (547 yards) apart.

5. The turns around the posts or buoys must be made alternately to the right and to the left, so that the flight will consist of an uninterrupted series of figures of 8.

6. The distance flown shall be reckoned as if in a straight line between the two posts or buoys.

7. The landing after the two distance flights is tests A and B shall be made:

- (a) By stopping the motor at or before the moment of touching the ground or water;
- (b) By bringing the aircraft to rest not more than 50 meters (164 feet) from a point indicated previously by the candidate.

8. All landings must be made in a normal manner, and the observers must report any irregularities.

The issuance of the certificate is always optional.

Official observers must be chosen from a list drawn up by the governing organization of each country.

Hydroaeroplane Pilot's Certificate

The tests to be successfully accomplished by candidates for this certificate are the same as



An instructor enlightening future airmen in the intricacies of coast defense.

those for an aviator's certificate, except that starting from and landing on the water is permitted in all of the tests.

United States Army Preliminary Flying Test

(a) Three sets of figures 8 around pylons 1600 feet apart. In making turns around pylons, all parts of machine will be kept within a circle whose radius is 800 feet.

(b) Stop motor at a minimum height of 300 feet and land, causing machine to come to rest within 150 feet of a previously designated point.

(c) An altitude test consisting of rising to a minimum height of 1000 feet.

(d) Glides with motor throttled, changing direction 90° to right and left.

NOTE.—(a) and (b) may be executed in one flight; (c) and (d) in one flight. The same rules apply in starting from and landing on water. Special attention will be paid to the character of landings made.

Report of these tests will be submitted to the officer in charge of the aviation section, with the information as to whether or not the school will complete the training of the aviator through the reserve military aviator stage.

If the preliminary flying test is passed satisfactorily and a candidate qualifies in other respects, he will be eligible for further instruction to qualify as a reserve military aviator.

United States Army Reserve Military Aviator Test

Reserve Military Aviator Test. The reserve military aviator test will be as follows:

(1) Climb out of a field 2000 feet square and attain 500 feet altitude, keeping all parts of machine inside of square during climb.

(2) Glides at normal angle, with motor

throttled. Spirals to right and left. Change of direction in gliding.

(3) At 1000 feet cut off motor and land within 200 feet of a previously designated point.

(4) Land over an assumed obstacle 10 feet high and come to rest within 1500 feet from same.

(5) Cross-country triangular flight of 30 miles, passing over two previously designated points. Minimum altitude 2500 feet.

(6) Straight-away cross-country flight of 30 miles. Landing to be made at designated destination. Both outward and return flight at minimum altitude of 2500 feet.

(7) Fly for 45 minutes at an altitude of 4000 feet.

Any candidate who successfully passes the Reserve Military Aviator tests will, on application, be granted the "Expert Aviator" certificate by the Aero Club of America. An aviator desiring this certificate must apply in writing to the Secretary of the Aero Club of America, 297 Madison Avenue, New York City, sending the report of his R.M.A. tests, certified by the commanding officer of the school, by one of the officers who witnessed the tests, or by one of the officers of the administrative staff, together with the sum of \$5.

The tests for the R.M.A. certificate are accepted in place of the club's own tests for the Expert Certificate. These are as follows:

1. A cross-country flight from a designated starting point to a point at least 25 miles distant, and return to the starting point without alighting.

2. A glide, without power, from a height of 2500 feet, coming to rest within 164 feet of a previously designated point, without the use of brakes.

3. A figure 8 around two marks 1640 feet apart. In making turns the aviator must keep all parts of his apparatus within semicircles of 164 feet radius from each turning mark as a center.

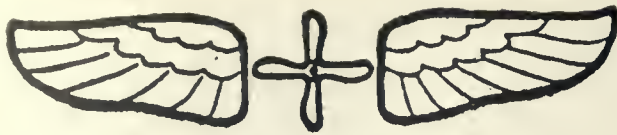

Enlisted Aviators



Observer



Aviation Mechanics.

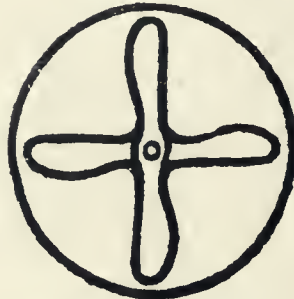

All enlisted men except aviation mechanics and enlisted aviators.



Junior Military Aviator



Military Aviator

The uniform insignia of the U. S. Aviation Service.

CHAPTER XV

REGULATIONS FOR UNIFORMS OF U. S. AERONAUTIC PERSONNEL

REGULATIONS AND SPECIFICATIONS FOR THE UNIFORM OF OFFICER AVIATORS AND ENLISTED MEN OF THE AVIATION SECTION OF THE SIGNAL CORPS APPROVED JUNE 22, 1917, BY THE SECRETARY OF WAR

Uniform Specifications

Body, to be double breasted, loose sack coat of soft russet leather, standard-lined throughout with kersey; to be easy fitting throughout, buttoned down the side with five large horn buttons.

Collar, standing and falling; standing, to be closed in front with hook and eye, and to be about one inch high; cloth of the collar to be of the same material as the coat, and not less than four inches, or more than five inches in width, an attachable flap of the same material as the coat, five inches in length and two inches in width, with buttonhole in each end to close the front of the collar when worn closed.

Pockets, two large hip pockets covered with a flap, slightly rounded at the corners, the opening to be horizontal and nine inches across; one large breast pocket on the left side with eight-inch vertical opening at the center line of the body, the pocket to slope down to the left. All pockets to be patch.

Skirt, to extend one third of the distance from the point of the hip to the bend of the knee, according to the height of the wearer.

Shoulder Loops, on each shoulder a loop of the same material as the coat, let in at the sleeve head-seam and reaching to the edge of the collar, buttoning up at the upper end with a small horn button, loops to be about two inches wide at the lower end, and one inch wide at the collar end, and cross-stitched throughout the entire length.

Sleeves, to have flaps with buttons to tighten sleeve around the wrist, one buttonhole in the flap, with two buttons on the sleeve for adjusting.

Coats, Aviator, Anti-Sinking

Body, to be single-breasted, sack coat of gaberdine with the anti-sinking material quilted between the outside and the lining, quality and quantity of the anti-sinking material to be of the approved standard, to button down the front with five horn buttons; sleeves not to be quilted.

Collar, to be a folding collar with a fold not more than two inches, the coat to fit snugly around the neck.

Pockets, two pockets, patch, one on each hip. Six inches horizontal opening without flaps.

Skirts, quilted skirt to extend one third of way to knee from the hip, according to the height of the wearer.

Shoulder Loops, on each shoulder a loop of same material as the coat, let in at the sleeve head-seam, and reaching to the edge of the collar, buttoning at the upper end with a small coat button; loops to be about two inches wide at the lower end and one inch wide at the collar end, and cross-stitched throughout the entire length.

Face Mask, Aviators

To be made of chamois in the proper shape to conform to the general shape of the head; skirts to lay flat on the shoulder and chest, and to be about six inches long. Eye, nose, and mouth holes to be cut in the proper place for each individual wearer.

Flying Suit

To be made of gaberdine of approved quality, unlined.

Body, a one-piece suit with opening in front from crotch to neck; fastened together with seven horn buttons.

Collar, a falling collar with one and one half inch fall, fitting snugly around the neck.

Shoulder Loops, on each shoulder a loop of gaberdine let in at the sleeve head-seam, and reaching to the edge of the collar, buttoning at the upper end with a small coat button; loops to be about two inches wide at the lower end, and one inch wide at the collar end, and cross-stitched throughout.

Pockets, to have two breast pockets, one on the right breast to have an eight-inch horizontal opening with button flap the height of armpit; the one on the left side to have a vertical opening nine inches in length without flap, but with button provided for closing; pocket to be large and extend in a downward direction toward the left hip.

Sleeves, sleeves to extend well down on the hand, and to be furnished with flaps for tightening around the wrist, flaps to be of the same material as the suit, with two buttons for adjusting.

Legs, to extend down to the ankles, fitting rather loosely, with a flap at the bottom of each leg for tightening around the ankle; two buttons for adjusting to be furnished.

Buttons, all buttons to be of horn, and of suitable size for the purposes for which they are to be used.

Gloves, Aviator, Winter

To be made of buckskin or pliable russet leather of approved quality, lined with fleece of unborn lamb.

Hand of glove to be of the mitten type, with the thumb compartment sufficiently large to permit of its being withdrawn and placed with the fingers. There shall be a slit across the in-



Summer flying suit of moleskin cloth, unlined, with winter cap of soft tan-colored leather.

terior of the hand, which will permit the fingers being extended in the opening, the slit must be sufficiently overlapped so that ordinarily it will remain closed.

Cuffs to be of the gauntlet type, made of soft leather and extending about one half the way up to the elbow, and to be the same color and material as the glove proper; the fur in the glove to extend two inches up the gauntlet from the wrist joint; a strap to be furnished for tightening the glove around the wrist.

Gloves, Aviator, Summer

To be the regular gauntlet type of soft unlined buckskin or russet leather, with soft gauntlet extending about one half the way to the elbow.

Goggles

Transparent part to be made of triplex glass; mounting for the glass to extend well away from the eyes; the part of the goggles nearest to the face to fit snugly, and conform to the general shape of the face in order to keep out the wind; an adjustable elastic tape to be furnished to hold the goggles in place.

Amber or clear glass to be used, according to the desire of those wearing them.

Helmet, Aviators, Summer

To be of the football type, of brown pliable sole leather, to be shaped to conform to the head and cover the entire head except the face. Ear flaps are to be attached for the protection of the ears, and by having shields to keep out the wind. The entire helmet is to be lined with felt one inch thick, and to be fastened under the chin with an elastic tape and tie string; proper holes for ventilation will be placed over the entire top of the helmet.

Helmet, Aviators, Winter

To be of soft russet leather lined with fur; to be shaped so as to cover the entire head except the face; to be fastened under the chin with a strap and buckle or patent snap, the front of the helmet to extend down to the eyebrow.

Aviation Service

Officers of the Aviation Service who are Military Aviators shall wear an insignia on the left breast, the insignia to be embroidered in silver on blue background, and shall be two wings with the shield between; the wings shall be three inches from tip to tip, each wing shall be one and one eighth inches long, and nine sixteenths inch wide at the contour ends; the shield shall be nine sixteenths inch high and five eighths inch wide, with the letters "U. S." one quarter inch high in the center below the horizontal cross lines. See exhibit A.

Junior Military Aviators shall wear on their left breast the same insignia described for the Military Aviator, except that the right-hand wing shall be omitted, the insignia consisting of one wing to the left of the shield. All officers in the Aviation service shall wear the Signal Corps crossed flags on their collar. See Exhibit A.



Chamois skin mask and leather coat.

Mufflers

Mufflers: To be closely-woven wool or camels' hair, O. D. color, sixteen inches wide and one and one half yards long, the ends to be made up with a fringe the same as those in common use.

Shoes, Aviator, Winter

To be of soft russet leather, lined with fleece, and extending one half way to knee; to have heavy sole, and made in the boot form or to be laced up wholly or partially in the front.

Boots, Rubber, Wading (wading pants)

To have regular boot feet, but the legs to extend up in regular trouser form, the top to be at a height just under the armpits; adjustable suspenders to be furnished for holding the tops up.

Breeches, Winter, Motorcycles

To be made of gaberdine, the same shape and style as the service breeches as issued. They will be lined with kersey throughout.

Face Mask, Goggles, Helmet: Same as for summer.

Hood: To be closely-woven O. D. wool, and cover the entire head except face; to fit snugly and extend well down on shoulders; must cover forehead down to eyebrows.

Insignia, Sleeve

Enlisted men of the Aviation Section shall have a navy blue cap let in at the sleeve head-seam and extending down the sleeve five and one half inches from the point of the shoulder. All men as hereinafter specified will wear the insignia as described.

A four-bladed propeller with center three and three fourths inches from point of shoulder, embroidered in white; the propellers to be two inches in diameter, two of the blades horizontal and the other two vertical; three fourths of an inch above the top tip of the vertical propeller blade a figure showing the number of the squadron to which the man belongs, one inch high, and embroidered in white. See Exhibit C.

Aviation mechanic, same as above with a white embroidered circle added, inside of circle to be one and one fourths inches from center of the propellers, outside of the circle to be one and three eighths inches from the center of the propellers. See Exhibit B.

Enlisted aviator, on the same blue background shall be embroidered in white, the insignia as hereafter described. A pair of wings with a five-inch spread with crossed propellers between them, each wing to be one and seven eighths inches long and seven eighths of an inch high at the inner edge. Propellers to be one inch across. One fourth inch above the top tip of the vertical propeller shall be embroidered the number of the squadron to which the man belongs in figures one half an inch high. See Exhibit C.

Leggins: All mounted men, and enlisted men of the Aviation Section, Signal Corps, canvas with leather reënforcement, as issued.

Muffler: Same as for aviators.

Overalls, Mechanics: To be of standard denim material, but made in one piece, to open up in front from crotch to neck, and button up with seven small buttons, to fit snugly around the neck, with no collar, each sleeve to be provided with a flap for tightening around the wrist; to have two hip and two back pockets, each pocket to have a six-inch opening, the legs to extend to the ankles, and to be provided with flaps for tightening around the ankles.

Changes In Regulations for the Uniforms of the United States Army, 1914, to Cover Aviation

Special articles of clothing for aviation purposes are provided and authorized as indicated hereafter. They are in addition to the usual articles of clothing for garrison and field service.

All officers and enlisted men on duty in the Aviation Section will obtain them on memorandum receipt from the Quartermaster. They will be held in addition to all the other clothing as required by these regulations.

Breeches for Motorcycle Messengers: In cold weather motorcycle messengers in the Aviation Section will wear kersey-lined gaberdine

breeches of standard pattern over their service breeches.

Officers detailed in the Aviation Section and qualified as Military Aviators will wear the double or if qualified as Junior Military Aviator the single wing shield over their left breast.

Officers detailed in the Aviation Section of the Signal Corps will wear the following insignia to show their qualifications:

Military Aviator: A silver-embroidered double wing shield on the left breast, above the line prescribed for badges and medals.

Junior Military Aviator: A single wing silver-embroidered shield on the left breast, above the line prescribed for badges and medals.

Rubber Wading Boots (wading pants): For use of officers and enlisted men on duty with Hydroaeroplane Squadrons, rubber wading boots with the top extending up, in the form of breeches, well beneath the armpits will be furnished. They will be held up by adjustable suspenders.

Coats, Leather, Aviator (or in case of water squadron, anti-sinking coats): Will be worn while engaged in flying, except in the tropics, where the leather coat may be dispensed with.

Face Mask: Of chamois, will be worn by officers and enlisted men flying or enlisted men riding motoreycles in cold weather.

Flying Suit: A one-piece flying suit of gaberdine used by all officers and enlisted men while flying. It will be worn under the leather coat.

Winter: They will be worn by chauffeurs and motorcycle messengers of the Aviation Section of the Signal Corps during cold weather.

Aviator: While engaged in flying, aviators will wear gloves prescribed, fur-lined mittens with gauntlet tops will be worn in cold weather, and the plain buckskin or leather gauntlets in warm weather.

Goggles: Improved type of triplex goggles will be worn by all aviators and motorcycle messengers in the Aviation Section of the Signal Corps while engaged in their respective duties. Chauffeurs will wear them in the winter. Clear



Brigadier-General B. D. Foulois, wearing the military aviator insignia.

or amber colored glass, according to the desire of the person using them.

Blue denim hat will be worn by enlisted men of the Coast Artillery, Quartermaster Corps, Aviation Section of the Signal Corps and Field Companies of the Signal Corps, when on duty on cable ships, with the fatigue uniform.

Helmets. Aviators and Motorcycle Messengers, will wear special helmets prescribed. In the summer they shall be of pliable russet leather, lined with felt; in the cold weather, aviators will wear a fur-lined soft russet leather helmet.

On the shoulder loops of the service and white uniforms, and aviators' outside suits or coats, metal insignia of rank will be worn as follows:

Enlisted men of the Aviation Service will wear embroidered insignia on the right sleeve just below the shoulder as follows:

Enlisted men in the Aviation Section will wear a white embroidered insignia with crossed propellers, with the number of their squadron

above, on blue background, on the upper, right sleeve.

Aviation mechanics will have in addition, a white, embroidered, circle around the propellers.

Enlisted aviators will wear an insignia with double wing, crossed propellers with the numerical designation of the squadron embroidered on the blue background on the upper right sleeve.

Mufflers: Aviators, motorcycle messengers and chauffeurs of the Aviation Section will wear an O. D., closely-woven wool muffler during cold weather.

While doing fatigue, enlisted men of the Aviation Section will wear a one piece denim mechanic's overalls, as authorized.

Officers, Aviation: A soft russet leather fleece-lined, high-top shoe with heavy sole will be worn by officer aviators while flying during cold weather.

Enlisted men aviators, and motorcycle messengers will wear high-top russet leather, heavy-soled shoes, lined with fleece, during cold weather, while flying or riding motorcycles.

Aviators and Motorcycle Messengers will wear special, closely-knit, all-wool, coat sweater during cold weather.

Aviation Officers: In addition to the articles listed under "a" and "b" for mounted and dismounted officers, officers acting as pilot will secure and have in their possession the following articles:

1. Aviator's winter helmet.
2. Aviator's summer helmet.
3. Clear or amber, triplex glass goggles.
4. Muffler.
5. One-piece flying suit.
6. Leather coat.
7. Aviator's winter gloves.
8. Aviator's summer gloves.
9. Aviator's winter shoes.
10. Aviator's sweater.
11. Aviator's face mask.

Note: In case of the officer being with a water squadron, an anti-sinking coat will be substituted for the leather coat.

UNIFORMS OF THE UNITED STATES ARMY

Table of Occasions

Officers

Service Uniform and Equipment

Occasions	By whom	Articles
		E.
		<i>In winter.</i>
		1. Aviator's winter helmet.
		2. Face mask.
		3. Goggles.
		4. Muffler.
		5. Flying suit.
		6. Aviator's winter gloves.
		7. Aviator's shoes.
		8. Sweater.
		9. O. D. Shirt.
		10. Service breeches.
		11. Leather Coat.
		E.
		<i>In summer.</i>
		1. Aviator's summer helmet.
		2. Goggles.
		3. One-piece flying suit.
		4. Leather coat.
		5. Aviator's summer gloves.
		6. O. D. Shirt.
		7. Service breeches.
		8. Russet leather shoes.
		9. Russet leather leggings.
		<i>In tropics.</i>
		Same as summer except omit leather coat.

NOTE 1. For water machines substitute in winter anti-sinking coat for leather coat. In summer, substitute anti-sinking coat for leather coat. In tropics, substitute anti-sinking coat for flying suit and leather coat.

E.

Add to garrison uniform.

On person

1. Identification tag.
2. First aid packet and pouch.
3. Watch.
4. Notebook and pencil.
5. Compass.

In machine

1. Haversack containing meat can, knife and fork, and spoon.
2. Canteen with cover.
3. Cup.
4. Field Glasses for Observers only.

NOTE:—When not flying, aviators and observers will substitute campaign hat for aviator's head gear.

Enlisted Men

Winter

1. Aviator's winter helmet.
2. Face mask.
3. Goggles.
4. Muffler.
5. Flying suit.
6. Aviator's winter gloves.
7. Aviator's shoes.
8. Sweater.
9. O. D. Shirt.
10. Service breeches.
11. Leather coat.

1a. For garrison duty while engaged in flying. All enlisted aviators and observers.

<i>Occasions</i>	<i>By whom.</i>	<i>Articles</i>	<i>Occasion</i>	<i>By whom.</i>	<i>Articles</i>
		<p><i>Summer.</i></p> <ol style="list-style-type: none"> 1. Aviator's summer helmet. 2. Goggles. 3. One-piece flying suit. 4. Leather coat. 5. Aviator's summer gloves. 6. O. D. Shirt. 7. Service breeches. 8. Russet leather shoes. 9. Russet leather leggings. <p><i>In tropics.</i></p> <p>Same as summer. Omit leather coat.</p> <p><i>Winter.</i></p> <ol style="list-style-type: none"> 1. Winter cap. 2. Alaskan Pea Jacket. 3. One piece mechanic's suit. 4. O. D. Shirt. 5. Service breeches. 6. Russet Shoes. 7. Arctics. 8. Gloves, woolen. 			<p><i>Summer.</i></p> <ol style="list-style-type: none"> 1. Service cap. 2. One piece mechanic's suit. 3. O. D. Shirt. 4. Service breeches. 5. Leather leggings. 6. Russet shoes. <p><i>Tropics.</i></p> <p>Same as summer, except, omit O. D. Shirt, and service breeches.</p> <p><i>Winter.</i></p> <ol style="list-style-type: none"> 1. Aviator's winter helmet. 2. Hood. 3. Goggles. 4. Face Masks. 5. Muffler. 6. Alaskan Pea Jacket. 7. Fleece-lined gauntlets. 8. Kersey-lined breeches. 9. Aviator's winter shoes. 10. O. D. Shirt. 11. Service breeches. 12. Leather leggings.
1c. For garrison duty, Aviation Section.	For mechanics.	<p><i>Summer.</i></p> <ol style="list-style-type: none"> 1. Blue Denim hat. 2. One piece suit, mechanics. 3. O. D. Shirt. 4. Service breeches. 5. Russet shoes. <p><i>Tropics.</i></p> <p>Same as summer. Omit shirt and breeches.</p> <p><i>Water Machines.</i></p> <p>Add wading pants, and omit one piece suit.</p> <p><i>Winter</i></p> <ol style="list-style-type: none"> 1. Winter cap. 2. Goggles. 3. Muffler. 4. Alaskan Pea Jacket. 5. Aviator's winter gloves. 6. O. D. Shirt. 7. One picce machanic's suit. 8. Service breeches. 9. Leggins, leather. 10. Russet shoes. 	1b. For garrison duty, Aviation Section.	For all motorcycle messengers.	<p><i>Summer.</i></p> <ol style="list-style-type: none"> 1. Aviator's summer helmet. 2. Goggles. 3. One piece mechanic's suit. 4. Gloves, summer, aviators. 5. Leather leggings. 6. O. D. Shirt. 7. Service breeches. 8. Russet shoes. <p><i>Tropical.</i></p> <p>Same as summer, except omit gloves, O. D. Shirt, and service breeches.</p>
1c. For garrison duty, Aviation Section.	For men tending. For Chauffeurs.		6a. For Field Service for Aviation	For enlisted aviators. For motorecycle men. For mechanics. For Chauffeurs.	<p><i>Add to garrison uniform.</i></p> <ol style="list-style-type: none"> 1. Identification tag.

CHAPTER XVI

AERONAUTIC MAPS

Maps have always been most important factors in military and naval operations, as they have been important factors in peaceful travel over land and water.

A map is as important to the aviator as it is to the navigator at sea. As the mariner's chart must tell the navigator of currents, depths of water, and location of rocks and reefs, so the aeronautic map must tell the aviator the character of the land and the configuration of the bodies of water below him. It must show the land as it is, the exact shape of cities, woods, and lakes; the trend of rivers, railroads, and roads; it must indicate clearly the prominent landmarks and the established aerodromes and open fields suitable for landings, etc., etc. In other words, the aeronautic map must show the contours and configuration of the land as closely as possible to the way it looks to the aviator from the air.

Five Types of Aeronautic Maps

There are four types of aeronautic maps used in the present war, and one type is in preparation in the United States. The former are as follows:

(1) *The General Aeronautic Map*.—This is based on existing maps, usually on a scale of 1:200,000, but differs from the average maps in that the roads are shown in red, the railroads in black, forests and woods in green, and waterways in blue.

(2) *The Special Aeronautic Map*.—(Illustrated herewith.) Besides including everything in the first chart, this shows aerodromes for aeroplanes and dirigibles, landing fields where there are no hangars, stations where gas for dirigibles is obtainable, the approximate shape of cities, towns, and villages, and such landmarks as prominent churches, railroad sta-

tions, windmills, smokestacks, castles, and monuments.

These maps are used in long-distance flights and raids. When a flight is planned the aviators go over the map, lay down the route to be followed, and study the details given on the map, together with any other information they may be able to obtain regarding the configuration of the land over which they will fly, possible landing places, etc. It is needless to add that the aviators make every effort to ascertain as nearly as possible the nature of the enemy country, in order to recognize the locations where bombs are to be dropped, as well as where anti-aircraft guns are most apt to be waiting.

(3) *The Special Aeronautic Map for Permanent Aerial Routes*.—This gives only important information required by the aviator to travel over a certain route. This type of map, which is illustrated herewith, originated in Italy, and has not yet been put into general use outside of Italy. It is a most remarkable map. The rivers and lakes are shown in blue, in their exact form. The roads are given in brown, the railroads in black. The approximate shape of cities and towns is given in black, and the most prominent building of each city or town, to be used as a landmark, is reproduced. The woods and forests are also shown; and the elevation at different points is given in meters, so that the pilot can rise in case he is caught in a fog after passing a given place, and thus avoid flying into a hill. In view of the fact that his altimeter or barograph gives only the altitude above sea-level, or the altitude from the point of start, it is necessary for the aviator to know the approximate elevation of the land below.

The aerial route to be followed, which is permanent, is marked in red dotted lines. The aerodromes are shown in red circles; the landing-places which permit landing from two points

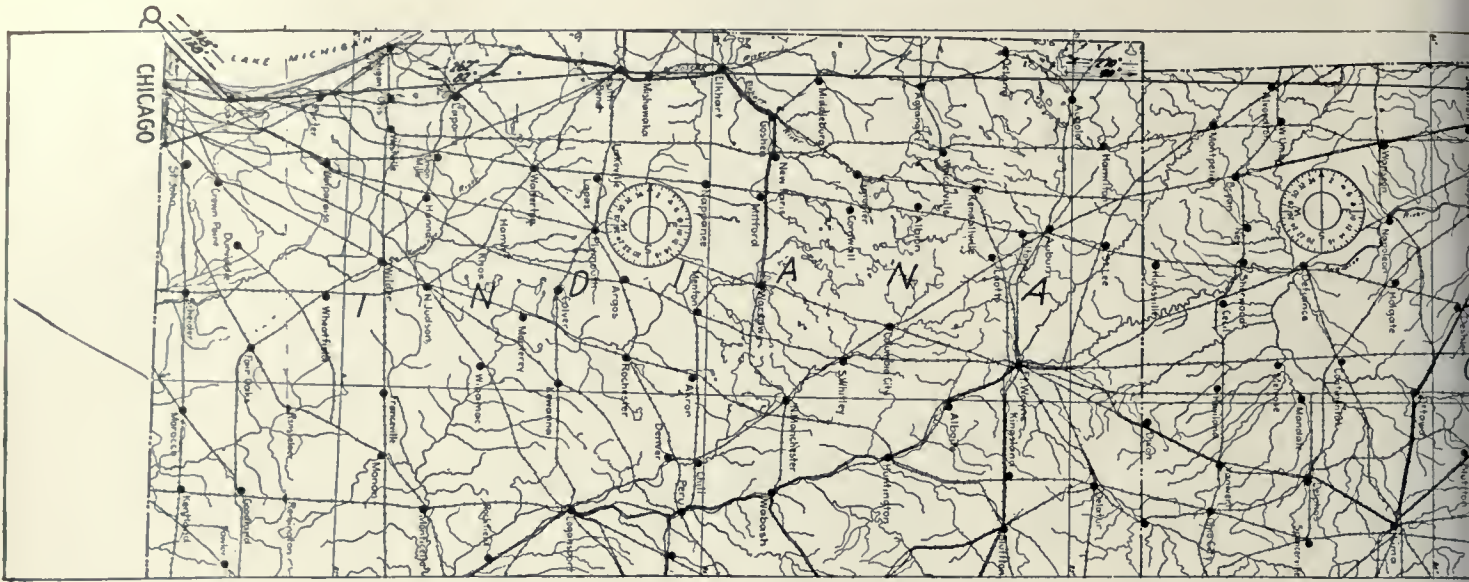

are indicated by two red dots of the same size, connected with a red line; the landing-places which permit landing only from one side are indicated by one red dot, connected by a short line and a smaller red dot. These dots are most important, as the large dot represents the approximate place where the wheel of the aeroplane must touch on landing. The line that connects it with the smaller dot shows the direction toward which the aeroplane must run in landing. The distance between the first dot and the second is usually about 300 meters, and the width is usually about 100 meters. This type of map greatly facilitates aerial navigation.

(4) *The Photographic Map of Sectors.*—Military operations are based on these maps.

This style of map is most important, and is corrected daily, often several times a day, to include the changes shown by photographs taken by aviators from their aeroplanes. These photographic maps show the configuration to the most minute detail and with the utmost care, as the success of certain operations depends upon the exactness of the smallest topographical detail.

Aerial photography is now almost an exact science. An aviator at a height of from 6000 to 8000 feet can take a photograph which will include and show clearly all of Manhattan Island; and the photograph can be enlarged to show the main streets, docks, bridges, and, of course, the buildings. A series of photographs could be taken from New York to Albany which

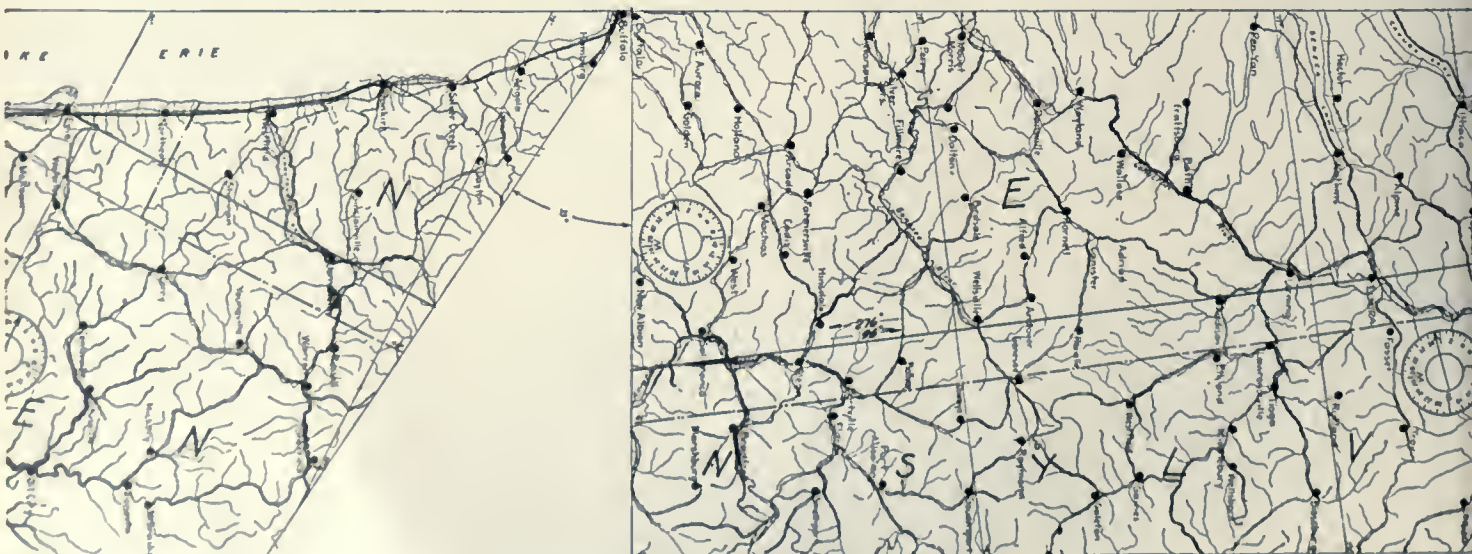

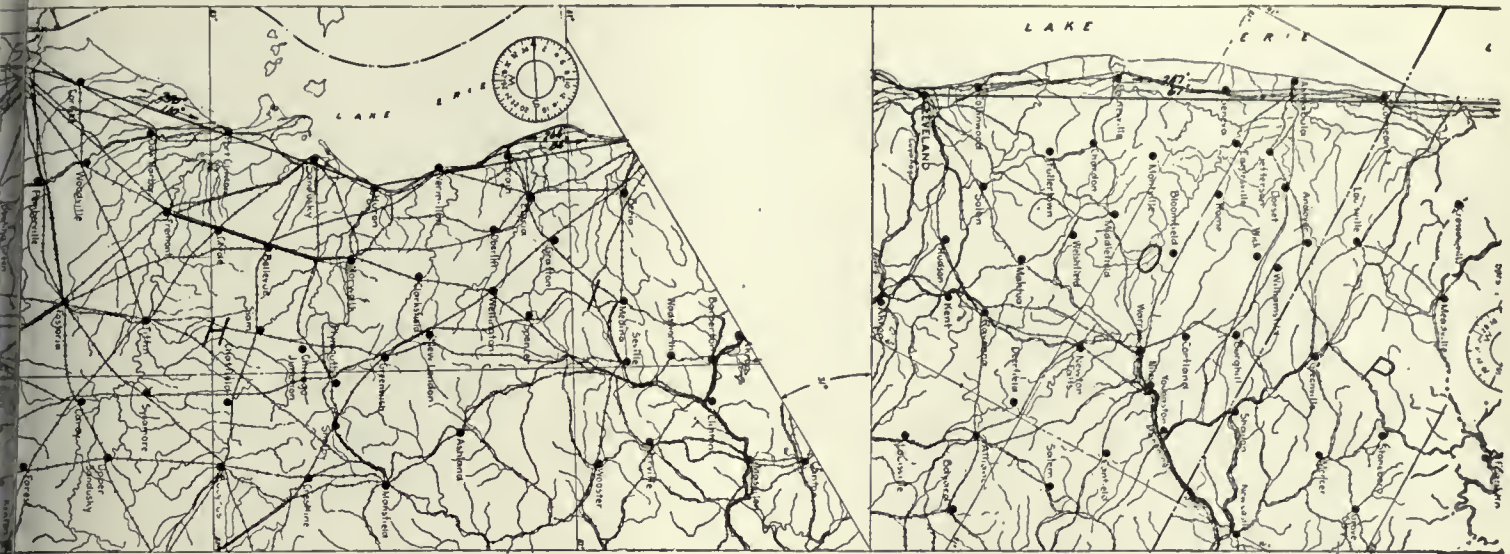

would permit making photographic maps of the entire route, and show every detail on an exact scale. This could not be accomplished, even with the expenditure of years of time and large sums of money, by any other method. The expert maker of photographic maps quickly figures out the scale, and combines photographs to make a continuous map.

An aviator might fly from Albany to New York in what is considered a slow aeroplane at about 70 miles an hour, and take a motion-picture of the entire route, giving the exact topographical conditions, thus permitting the military authorities within twenty-four hours to conduct operations with absolute certainty as to conditions obtaining throughout this region.

(5) *The Sperry Aeronautic Map.*—This

type of map is made on the basic principle of the "Special Aeronautic Map for Permanent Air Routes" described above, although it was evolved entirely independently of the latter, and has several improvements.

Mr. Lawrence B. Sperry has been working on these maps and with the coöperation of the Committee on Aeronautic Maps and Landing Places of the Aero Club of America, the Aerial League of America, and the Aeronautic Library is preparing a map of the Wilson Airway from New York to San Francisco, which will make it possible for an aviator to fly across the continent without the possibility of losing his way.

Maps of the air-routes between New York and Chicago, New York and Newport News,



Va., and about Long Island, have also been prepared and are ready for the insertion of the aerodromes now being established by the Army Air Service and civil organizations, and of other landmarks.

The plan is to also show on the map the landing-places for twenty-five or fifty miles on either side of the straight route, and eventually to give sketches of the shape of cities and towns, or the more prominent landmarks which strike the eye of the air-traveler.

The map being prepared of the Wilson Aerial Highway will cover a straight route from New York to San Francisco, but there will be lines leading from the main line to central landing-places, such as Erie, Cleveland, and Detroit. All the headings are magnetic on these maps, and the arrows indicate headings in either direction.

The true heading from one city to another is determined by projecting the line of flight between these two cities, and then transferring this line, by means of parallel rulers, to the nearest compass rose, from which the true heading is obtained. As the difference between the geographical and magnetic North Pole differs at various places on the earth's surface, it is necessary to correct frequently for this difference, which is known as "variation." In the vicinity of Chicago the magnetic needle is found to point to true geographical north, but as the journey is continued eastwardly, the error will be noticed to increase to almost 10 degrees west at New York. As all the headings on this chart have been laid out "magnetic," or with variation taken into consideration, the pilot simply steers his craft on the charted headings. Wherever the variation is east, it is necessary to subtract from the true heading, and when it is west, one must add the necessary number of degrees, in order to obtain the proper indication.

As soon as regular air-lines are established to carry passengers and mail, and aircraft start from a given station at a given time daily, there will be added to this map the approximate time at which aircraft will pass certain places, so that the aviator can navigate the air with even less trouble than the sailor navigates the sea. In fact, an aeroplane equipped with the Sperry

automatic pilot could be set to follow the compass direction in trips of a few hundred miles, and thereafter the pilot would have practically nothing to do, as the automatic pilot would control his machine completely. The pilot would only have to guard against the drift due to side-winds, which he would do by occasionally glancing at his map and looking below to see whether the prominent landmarks checked with the landmarks shown on his map. Knowing the speed of his machine, and having the approximate time required to reach different places, a glance at the watch would tell him at what point he should be at that hour, when he could ascertain whether the landmarks below were similar to those shown on the map.

The Map with Photographic Reproduction of Route and Information Regarding Prevailing Winds

As soon as large aeroplanes with a broad dash-board are used, it will be possible to make maps larger, and to include on the margins a film reproduction of the entire route, or merely important places. It may also be found advisable to print on the margin information regarding prevailing winds to be met at different altitudes.

It may later be found that films can easily be taken of the entire route from New York to San Francisco, and between other control points. Such a film can be enlarged to have a width of between 9 and 12 inches, and the water can be painted blue, the forests and woods green, the roads brown, the railroads black, the aerodromes red, etc. This will furnish an exact map, not only for the aviator, but for other commercial and scientific purposes, such as developing railroads and highways, and surveying for various purposes.

It is quite possible that the entire cost of making a photographic aeronautic map of the route between New York and San Francisco will not be found as high as that of surveying a few miles to make an average topographic map.

The War Prevented an International Convention on Aeronautic Cartography

The war prevented the assembling of an international convention, held under the auspices

of the Aero Club of America, to discuss and decide on the basic principles for an aeronautic map of the world to be adopted by all nations. This convention was being arranged in the United States by the Aero Club at the suggestion of Rear-Admiral Robert E. Peary, Chairman of the Committee on Aeronautic Maps and Landing-Places of the Aero Club of America. Admiral Peary attended the Tenth International Geographical Congress, held at Rome in January, 1913, at which the subject of aeronautic maps was discussed. The report of this congress and the principal address delivered were translated from Italian by the writer and printed in "Flying," the organ of the Aero Club of America, for September and October, 1913.

At this conference no decision was reached, or action taken, toward adopting basic principles for the making of aeronautic maps, because it was agreed by the delegates, as it had been agreed by the delegates that attended the congress of the International Aeronautic Federation at Vienna in June, 1912, that the first step to be taken should be to agree on a scale and conventional signs to be adopted for an aeronautic map of the world. The aeronautic map of the world was then to be supplemented by aeronautic maps of different countries, and of parts of different countries, to be made on the accepted scale with the use of the same conventional signs.

It was to bring about this international agreement that the Aero Club of America was arranging to hold an international convention in the United States, the object being to do for the world aeronautic map what was done for the world chart, as proposed by the International Geographical Congress at Geneva in 1908. The purpose of this congress was not only to agree on a scale and conventional signs to be adopted for the world aeronautic map, but also to make the necessary arrangements, through diplomatic channels or otherwise, to facilitate the execution of those sheets of this map which overlapped the frontiers of different countries.



A Sperry map-holder and map.

The war prevented the holding of this convention, but the committee on aeronautic maps and landing-places of the Aero Club of America continued its work to advance this project. The members of this committee are as follows: Rear Admiral Robert E. Peary, Chairman; Henry Woodhouse, Vice-Chairman; Bion J. Arnold, Vincent Astor, A. G. Batchelder, George F. Baker, Jr., Captain Robert A. Bartlett, Bernard H. Baruch, August Belmont, James Gordon Bennett, Cortlandt F. Bishop, Captain Mark L. Bristol, U. S. N.; Starling Burgess, Godfrey L. Cabot, President Aero Club of New England; President Manuel Estrada Cabrera of Guatemala; Major Joseph E. Carberry, U. S. A.; Major C. C. Culver, U. S. A.; Newcomb Carlton; Lieut. Col. Charles De F. Chandler, U. S. A.; Captain W. I. Chambers, U. S. N.; J. Parke Canning, Roy D. Chapin, Alexander Smith Cochran, Robert J. Collier, Howard E. Coffin, Chairman Aircraft Production Board; Roy U. Conger, Glenn H. Curtiss, Commander Cleveland Davis, U. S. N.; Lieut. F. Trubee Davison, N. R. F. C.; Lieut. Col. E. A. Deeds, S. O. R. C.; Charles de San Marsano, Charles Dickinson, President Aero

In 1910 officials of the Automobile Club of America and the Aero Club of America combined their efforts to make a topographical map of Western Long Island for aeronautic purposes.

The Aero Club of France started, in 1911, to make an aeronautic map of France. This aeronautic map was to consist of about 100 sheets, 24 of which have already been issued and are used extensively by the French and British Flying Corps. Mr. Charles Lallemand, the well-known French scientist, is the chairman of the aeronautic maps committee of the Aero Club of France. The basic principle on which aeronautic maps are now being made by the Aero Club of France has been revised so as to bring them up to date and meet military needs.

In Italy the work of making aeronautic maps has been shared between the aeronautic authori-

ties, the authorities of the Touring Club of Italy, and the members of the National Commission of Aerial Touring. The Italian pioneers in aeronautic topography include Senator G. Celcra, the chairman of the National Commission on Aerial Touring; Commander Giovanni Roncagli, Royal Italian Navy and secretary general of the Tenth International Geographical Congress; Mr. C. Usuelli, and other well-known Italian scientists. The pioneer work of these organizations has been of great value to the military authorities of their respective countries during the present war. In France and Italy the Aero Clubs were practically the only sources from which the necessary information covering aeronautic maps could be obtained, as no attention had been paid to this subject before the war by the military authorities.

CHAPTER XVII

HISTORY OF UNITED STATES ARMY AERONAUTICS

As related in the chapter on "The Evolution of the Military Aeroplane," the United States Army holds the distinction of being the first army in the world to acquire an aeroplane.

The order for the first Wright machine was placed early in 1908, and tests were made at Fort Myer, Va., in September of that year. These resulted in an accident on September 17, in which Orville Wright, the pilot, was severely injured, and Lieutenant E. Selfridge, the passenger, was killed. The next tests took place at Fort Myer in July, 1909. This machine was accepted by the Government, and Lieutenants Frank Purdy Lahm and Benjamin D. Foulois were assigned to receive instruction from the Wrights.

An aviation camp was established at College Park, Md., and Captain Charles DeF. Chandler, then disbursing officer of the Signal Corps, was appointed Officer in Charge of the Aeronautic Division. The following officers were taught to pilot the Wright machine by Wilbur Wright during October and November, 1909: Captain Charles DeF. Chandler, Lieutenant F. P. Lahm, Lieutenant Benjamin D. Foulois, Lieutenant Frederick E. Humphreys, Lieutenant T. deWitt Milling, Lieutenant H. H. Arnold, and Lieutenant George C. Sweet, the last being assigned by the Navy Department.

The first dirigible, delivered to the United States Army by Captain Thomas G. Baldwin, was first flown at Fort Myer with Lieutenant Frank P. Lahm of the 7th Cavalry in charge, and then was sent to Omaha in the autumn of 1909, with Lieutenants R. S. Bamberger of the 2nd Cavalry, John G. Winter of the 6th Cavalry, and Oliver A. Dickinson of the 5th Infantry in charge. These officers and Lieutenant Frank P. Lahm were subsequently returned to duty with their respective regiments, because of regulations prescribing a time limit during

which officers of line organizations could serve on special details. Lieut. Foulois was sent to San Antonio to teach himself to fly with the Wright machine.

Owing to the failure of Congress to allow an appropriation for army aeronautics, the work of developing this branch of the service practically ceased in 1910-11, and officers attached to the Aeronautic Division kept up their practice mainly by attending aviation meets and following the development of civilian aviation.

During the Mexican outbreak in February and March, 1911, the United States Army had no aeroplanes to send to the Mexican border. It was enabled to put an air scout at the disposal of the Government through the courtesy of Mr. Robert J. Collier, the president of the Aero Club of America, who loaned the army his Wright aeroplane. With this machine Lieutenant B. D. Foulois and Mr. P. O. Parmalec, made a number of flights along the Mexican border, reconnoitering and carrying messages from General Carter to Major George O. Squier.

During the winter of 1911 Lieutenant Paul W. Beck, G. E. M. Kelley, and John C. Walker were assigned to take a course of training at the Curtiss Aviation School at San Diego, Cal. They were assigned to duty at San Antonio, Texas, in April, 1911, to fly the Curtiss machines acquired by the United States Army.

The first army officer to be granted an F. A. I. pilot's certificate was Lieutenant F. P. Lahm. Lieutenants H. H. Arnold and T. deWitt Milling, Captain Charles DeF. Chandler, Lieutenant Benjamin D. Foulois, Captain Paul W. Beck, Lieutenant R. Carrington Kirtland, Lieutenant J. W. McClaskey, Lieutenant William C. Sherman, Lieutenant Harry Graham, and Captain Frederick B. Hennessey, were the

next ten army officers to obtain a pilot's certificate.

By the Act of Congress of March 3, 1911, there was made available the sum of \$125,000 for army aeronautics. This appropriation made it possible to establish a substantial aviation camp at College Park, Md. This was moved to Augusta, Ga., during the four winter months of 1912-13.

Seven aeroplanes were bought for the United States Army in 1911. Three were Wrights, three were Curtiss machines, and one was a Burgess biplane. Important experiments were conducted at College Park during 1911-12, including the testing of the Lewis gun and the Scott bomb-dropping device; also experiments in sending wireless messages from an aeroplane, map-making, and other pioneer work.

Early in 1912 steps were taken to form an aviation section in the Philippines, and one aeroplane in charge of Lieutenant Frank P. Lahm was sent to the islands for that purpose.

Lack of funds and shortage of personnel pre-



Col. (now Gen.) Squier was the Chairman of the Joint Army and Navy Committee ordered to conduct the tests of the first Army aeroplane in 1908. The above photograph shows the aeroplane in the air at Fort Meyer, Va., on September 12th, 1908, when Orville Wright and Col. Squier, who was the first passenger, made a flight of 9 minutes six seconds, which was a record for many months.



The Baldwin dirigible, first and only dirigible acquired by the United States Army up to 1917, being put through the tests, August, 1908.

vented expansion of the air service and extension of the work of the existing organization.

The Act of August 24, 1912, appropriated \$100,000 for the purchase, maintenance, operation, and repair of aircraft. Twelve aeroplanes were bought in that year. Major Samuel Reber was put in charge of the Aeronautic Division.

The exact number of machines and aviators and the distribution of the United States Army Aviation Squadron in June, 1913, was as follows:

	Officers	Machines	
		Training	High-powered
Texas City, Texas	11	6	4
San Diego, Cal.	5	1	1
Philippine Islands	1	1	1

Four officers were on temporary duty learning to fly, and Fort Leavenworth, Kansas, had one high-powered machine.



This photograph, which was taken by James H. Hare, at the Mexican border in 1911, shows Col. (now Gen.) Squier on the left after receiving a message carried by Captain (now Brig.-Gen.) Benjamin D. Foulois and Philip O. Parmelee. The aeroplane was loaned to the Army by Mr. Robert J. Collier, then president of the Aero Club of America.

The general equipment of this handful of aviators consisted of the barest necessities. The allowances made by Congress in 1911 and 1912 were too meager to afford more than the necessary aeroplanes, tents, and spare parts, while the 1913 allowance of \$125,000 was barely sufficient to replace the wornout machines and afford maintenance. It was not possible, therefore, to acquire motor-truck repair-shops, motor-trailers, extra motors, and such other equipment as was absolutely necessary to create an efficient organization.

Lacking funds, the Signal Corps was unable to replace the army dirigible, or to extend the acrostatic section. Therefore work in that branch of the service practically ceased.

Aeroplanes were first used in military manœuvres in August, 1912. Two machines were assigned to these manœuvres, in charge of Lieutenants B. D. Foulois and Harold Geiger, Captain F. B. Hennessey, Lieutenant T. deW. Milling, and Lieutenant Harry Graham.

A plan to give the army 120 aeroplanes and to establish a number of aviation centers was proposed by the Secretary of War in a special report to Congress in response to Resolution 444, House of Representatives, March 26, 1912, (House Document No. 718, 62d Congress, 2d Session), but Congress took no action on it.

The Act of March 2, 1913, allowed a detail not to exceed thirty officers of the line of the army to aviation duty, and gave extra pay to officers engaged in flying.

The Act approved July 18th, 1914, authorized an increase of the Signal Corps by the addition of an Aviation Section. Previous to the passage of this Act there was no definite provision of law covering the duties of the Signal Corps with respect to aviation. Under this Act the Aviation Section was authorized to have sixty officers and 250 enlisted men. But the shortage of officers in every branch of the service prevented getting more than half that



The first tests of the now famous Lewis gun were made by United States Aviators. Captain Charles de F. Chandler and Lieutenant T. De Witt Milling at College Park, Md., June 7th-8th, 1912.

The Mexican Campaign Found the United States Army Unprepared Aeronautically

Our utter aeronautic unpreparedness was shown in March, 1916, when Villa raided Columbus, New Mexico, and other American localities along the Mexican Border, killing Americans and destroying property. Villa raided Columbus on March 9, and on March 11, Secretary of War Baker ordered General Scott, Chief of Staff, to instruct General Funston to use, as far as possible, the Aero-Squadron stationed at Fort Sam Houston, San Antonio, Texas, in his expedition against Villa. General Funston realized that an aeroplane was easily worth 5000 men in the Mexican campaign, and that scouts, other than aerial, faced death in crossing the Mexican Border. As General Funston pointed out: "Villa parties will at times surprise these scouting parties. In ordinary warfare our men might, if hopelessly outnumbered and resistance were futile, surrender with safety. To surrender to Villa, however, would be worse than suicide. Villa's men will kill every American they can lay their hands on. Every encounter with them means a fight to the death for our men."

The aero-squadron at Fort Sam Houston included Captain Benjamin D. Foulois, Captain

T. S. Dodd, Lieutenant J. E. Carberry, Lieutenant T. S. Bowen, Lieutenant Ira D. Rader, Lieutenant C. C. Chapman, Lieutenant H. A. Dargue, Lieutenant Edgar S. Gorrell, Lieutenant W. G. Kilner, and Lieutenant R. H. Willis. These aviators joined General Pershing at Casas Grandes, Mexico, about 110 miles from the border.

The squadron had only eight small, low-powered scout-aeroplanes, not suitable for flights of over 50 miles from their own base and certainly not adapted for the difficult conditions under which the aviators had to fly. It also lacked general equipment required to keep an aero-squadron in the field. On March 27, Secretary Baker made known that there were only two aeroplanes in commission for use by the Mexican Expedition, and that General Funston had asked for more. In his statement Secretary Baker said: "The wireless communication is reported to be intermittent, because of the static conditions in the electric field there. For this reason additional importance is given to the request for aeroplane facilities."

Congress was asked for an emergency appropriation of \$500,000 for aeroplanes. This sum was provided on March 28, when the Army Deficiency Bill passed the House by a vote of 373 to 1.

Lieutenant Colonel George O. Squier, who had been military attaché at the United States Embassy at London, was appointed to take charge of the Aeronautic Division of the United States Army.

Meanwhile the two available aeroplanes were kept in daily service carrying despatches and reconnoitering between General Pershing's camp at the front and Columbus, N. M. On April 22 a despatch stated that they were out of commission, being repaired at Columbus, and the expeditionary force in Mexico was without air scouts.

It was soon evident that the \$500,000 emergency appropriation would only meet a fraction of the needs, and that the appropriation of \$1,222,000 asked for aeronautics for the next fiscal year would be too small to permit starting a substantial air service. The Aero Club of America then undertook not only to arouse the country to the need of a substantial air service, but also to create a reserve of trained aviators.

For several years previously the Aero Club of America had been urging the expansion of the army air service, and while it had succeeded in creating what little interest there was in the subject, it was far from achieving its aims. These aims were: "To give the United States 5000 aviators, placing this country in the posi-

tion of the porcupine, which goes about its daily peaceful pursuits, harms no one, but is ever ready to defend itself."

Finding it impossible to get authorization for assigning even 500 army officers to aviation, the Aero Club turned to forming a reserve of National Guard officers from different states. Patriotic citizens contributed to carrying out this plan.

Mrs. William H. Bliss contributed through the club the funds necessary to purchase an aeroplane and train officers of the National Guard of New York, starting an aero company at Mineola, Long Island. Lieutenant Raynal C. Bolling was commanding officer of this company, which some months later gave the country a score of good aviation reserve officers.

Messrs. Emerson McMillin, T. Jefferson Coolidge, Barend Van Gerbig, and others, made substantial contributions, and the Curtiss Company offered to train an officer from the National Guard of each state.

When Villa raided Columbus the Aero Club offered to present a number of aeroplanes to the United States Army and to supply a number of volunteer aviators. This offer was declined. But when the two aeroplanes in Mexico went out of service and the Carrizal tragedy took place, a request was sent to the club by the sig-



The Hangars at the U. S. Army Aviation School at College Park, Md., 1911.



Four of the aeroplanes of the First Aero Squadron at Columbus, New Mexico.

nal officer for volunteers, and an officer was assigned to work with the club in mobilizing civilian aeronautic resources.

The list of volunteers submitted by the club included about fifty civilian aviators and the following National Guard officers. The latter were assigned by their respective Adjutant-Generals, whose names also follow:

Arkansas.—Brigadier-General Lloyd England, the Adjutant-General, detailed Second Lieutenant Forrest Ward to report at the Curtiss Aviation School, Newport News, Va., for training.

Colorado.—Brigadier General John Chase, the Adjutant-General, detailed Lieutenant Cummings, Signal Corps, National Guard of Colorado, to report to the Curtiss Aviation School, Newport News, Va., for training.

Connecticut.—Brigadier General George M. Cole, the Adjutant-General, detailed Captain Ralph L. Taylor, of the Connecticut Coast Artillery of Stamford, Conn., to report to the Curtiss Aviation School, Newport News, Va., for training.

Georgia.—Brigadier General Van Holt Nash, the Adjutant-General, detailed Sergeant L. V. Smith to report at the Curtiss Aviation School, Newport News, Va., for training.

Kentucky.—Brigadier General H. Tandy Ellis, the Adjutant-General, detailed Lieutenant B. Osborn, of the Signal Corps, to report at the Curtiss Aviation School, Newport News, Va., for training.

Minnesota.—Brigadier General Fred W. Wood, the Adjutant-General, detailed Geo. M. Palmer to report at the Curtiss Aviation School, Newport News, Va., for training.

Nebraska.—Brigadier General P. L. Hall, the Adjutant-General, detailed Captain Ralph E. McMillin, a licensed pilot, to report at the Curtiss Aviation School, Newport News, Va., to qualify for the "Superior" or "Expert" License issued by the Aero Club of America. This was in response to the Aero Club of America's telegrams sent out March 12. The cost of obtaining this license was borne by the National Aeroplane Fund.

New York.—The Aviation Company of the National Guard of New York, which had been training at the Mineola Aviation Field comprised the following gentlemen:

Captain Raynal C. Bolling; Lieutenant N. Carolin; J. E. Miller; A. B. Thaw, 2d Master Signal Electrician; R. J. Gilmore; First-Class Sergeants P. R. Stockton, F. R. Dick; Quartermaster Sergeant W. T. Odell; Sergeants J. H. Stevenson and E. A. Kruss; Corporals D. G. Frost, D. R. Noyes, E. B. Hagerty, W. P. Willetts, J. R. Speyers, H. H. Salmon, Jr., P. J. Roosevelt, F. J. Hoppin; Privates E. C. Best, F. Boger, Jr., K. J. Bevans, W. W. Conant, Jr., A. M. Craig, J. T. Dwyer, A. L. Favre, C. C. Goodrich, P. J. Henry, W. T. Howell, J. F. Hubbard, W. C. Jenkins, W. J. Johnson, R. J. Knowlson, E. McCormick, E. Martin, D. P. Morse, R. M. Olyphant, Jr., C. H. Reynolds, R. F. Russell, P. D. Smith, J. D. Sullivan, T. F. Ward, and Trumpeter W. L. Rockwell.

Buffalo, N. Y.—Two members of the Buffalo Aero Squadron reported at the Curtiss Aviation School, Newport News, Va., to receive the same course of training given the militia officers of the various states, detailed for instruction by the Ad-

jutant-Generals of their respective states. These two men were: Messrs. Willis G. Hickman and Morgan More.

Lieutenant Edward Bagnell was detailed to accompany Captain McMillin to Newport News for training.

New Hampshire.—Brigadier General C. W. Howard, the Adjutant-General, detailed Lieutenant Arthur J. Coyle, of the 1st Infantry, to report at the Curtiss Aviation School, Newport News, Va., for training.

North Carolina.—Brigadier General L. W. Young, the Adjutant-General, detailed Lieutenant D. B. Byrd, of Company F, 2nd Infantry, to report at the Curtiss Aviation School, Newport News, Va., for training.

Ohio.—Brigadier General W. B. Hough, the Adjutant General, detailed Lieutenant R. H. Hoyer, to report at the Curtiss Aviation School at Newport News, Va., for training.

Oklahoma.—Brigadier General F. M. Canton, the Adjutant-General, detailed Sergeant Harrison Handley, of the Infantry, to report at the Curtiss Aviation School, Newport News, Va., for training.

Oregon.—Brigadier General Geo. H. White, the Adjutant-General, detailed Captain Frank W. Wright to report to the Curtiss Aviation School at San Diego, California, for training.

Chief Mechanic Bairn, an experienced aviator, was detailed to accompany Captain Wright to San Diego to qualify for the "Superior," or "Expert," License issued by the Aero Club of America.

Tennessee.—Brigadier General C. B. Rogan, the Adjutant-General, detailed Lieutenant Curry A. McDaniels, of the Infantry, to report at the Curtiss Aviation School, Newport News, Va., for training.

Texas.—Brigadier General H. Hutchings,



Mustering into the Federal Service the First Aero Company, N. Y. N. G., at Mineola, which was started through the contribution of Mrs. William H. Bliss and trained at private expense, close to \$60,000 contributed largely through the Aero Club of America. Most of these men became members of the Signal Officers Reserve Corps. The personnel of the Aero Company, which includes many members of prominent New York families, as mustered in, was as follows: Captain Raynal C. Bolling, Lieutenant N. Carolin, J. E. Miller, A. B. Thaw, 2nd Master Signal Electrician; R. J. Gilmore; First-Class Sergeants, P. R. Stockton, F. R. Dick; Quartermaster Sergeant, W. T. Odell; Sergeants, J. H. Stevenson, E. A. Kruss; Corporals, D. G. Frost, D. R. Noyes, E. B. Hagerty, W. P. Willets, J. R. Speyers, H. H. Salmon, Jr., P. J. Roosevelt, F. J. Hoppin; Privates, E. C. Best, F. Boger, Jr., K. J. Bevens, W. W. Conant, Jr., A. M. Craig, J. T. Dwyer, A. L. Favre, C. C. Goodrich, P. J. Henry, W. T. Howell, J. F. Hubbard, W. C. Jenkins, W. J. Johnson, R. J. Knowlson, E. McCormick, E. Martin, D. P. Morse, R. M. Olyphant, Jr., C. H. Reynolds, R. F. Russell, P. D. Smith, J. D. Sullivan, T. F. Ward, and Trumpeter, W. L. Rockwell.



A squadron of American training machines at one of the Army Aviation Schools in 1916.

the Adjutant-General, detailed Lieutenant Byron McMullen to report at the Curtiss Aviation School, Newport News, Va., for training.

Vermont.—Brigadier General Lee S. Tillotson, the Adjutant-General, detailed Lieutenant Harold P. Sheldon, of the 1st Infantry, to report at the Curtiss Aviation School, Newport News, Va., for training.

Virginia.—Brigadier General W. W. Sales, the Adjutant-General, detailed Corporal Greenlow Johnston, of the Signal Corps, Virginia National Guard, to report at the Curtiss Aviation School, Newport News, Va., for training.

West Virginia.—Brigadier General John C. Bond, the Adjutant-General, detailed Lieutenant Howard F. Wehrle, to report at the Curtiss Aviation School, Newport News, Va., for training.

As the United States Army had no authorization to enroll civilians in an aerial reserve corps, the latter applied to the Aero Club of America. Applications were received at the rate of one thousand per month. The club urged Congress to provide for an aerial reserve, and on

May 25, 1916, Mr. Alan R. Hawley, the president of the club, flew from New York to Washington with Victor Carlstrom, carrying a special edition of the "New York World" containing indorsements from governors and other state authorities of the plan to train 2000 aviators. As soon as the National Defense Act of June 3, 1916, was passed,—an act which provided for the enrolling of officers and men in the Officers' and Enlisted Men's Reserve Corps,—a committee of the club, consisting of Messrs. Alan R. Hawley, Congressman Murray Hulbert, Ralph Pulitzer, Robert J. Collier, and the writer, waited on President Wilson and urged him to authorize the organization of the Aerial Reserve Corps.

On July 13, 1916, a telegram from the White House advised the club that the President had authorized the organization of the Aerial Reserve Corps.

In the meantime a most energetic campaign of public education was conducted by the club to bring about an increase of the aeronautical appropriation from \$1,222,000, as estimated, to \$29,000,000, the sum urged by the club. An



Some of the acroplanes in use at the Army Aviation Field at San Diego in 1916.



The International Aircraft Standardization Committee, which met in Washington, August 14-15, for the first time. Seated, left to right, F. G. Diffin, U. S., Chairman; G. L. Norris, U. S.; Lieut. M. Mignot, France; Capt. J. Herck, France; A. B. Rogers, England, and S. G. Payne, England. Standing, P. D. Merica, Bureau of Standards; F. G. Ericson, Canada; W. F. Prentice, England; Capt. A. Pomilio, Italy; J. S. MacGregor, U. S.; H. Chase and Dr. G. K. Burgess, both of the U. S. Bureau of Standards.

amendment, proposed by Congressman Murray Hulbert when it first came before the House, to increase the appropriation to \$14,000,000, was defeated on a point of order. An amendment proposed by Congressman James Mann, was adopted, however. This amendment increased the appropriation to \$3,500,000. Senator George E. Chamberlain, the chairman of the Committee on Military Affairs, next introduced the amendment in the Senate, and while it met with difficulties, it finally was adopted, the appropriation allowed being \$13,861,000.

This appropriation permitted the Signal Corps to develop the aeronautic division on a more substantial basis, and gave this country a year's start toward improved aerial developments.

The Chief Signal Officer, in his report dated October 3, 1916, has stated that there were thirty-nine officers detailed in, and forty-six students attached to, the Aviation Section.

An official report issued October 20 stated that the Aviation Section, "ordered 175 aeroplanes for the Army and soon will order 100 hydroaeroplanes and 100 training school machines to be used in training the Army and the National Guard." The report also announced that orders had been signed on that date for the formation at San Diego of the Second and Third Aero Squadrons for the Army.

The Report stated further that "the Army has 45 junior military aviators, with a tactical staff of six officers, has 38 officers under instruction at San Diego, where they have been turned out at the rate of eight a month.

"Major Charles de F. Chandler of the Signal Corps, who has had practical experience in ballooning, has been placed in charge of all military balloon work, and bids have been advertised for four army balloons, two spherical and two kite. The balloon section may be established at Omaha or at Akron.

"The Army will train officers in flying at San Diego, where it has eleven training machines which are to be increased by eighteen hydroaeroplanes. There are six machines at the Mineola training school on Long Island, and twelve under order for use there. There are four machines at the Chicago training station and twelve ordered. The army bill appropriated \$300,000 for purchase of land in California for aviation school purposes and \$300,000 for another large tract. A special board is now considering the selection of the second site in the East.

"The army has only one thoroughly equipped aero squadron. It is at Columbus, N. M., and has twelve 160-horse-power reconnoissance type of Curtiss aeroplanes, one Curtiss twin-tractor of 200 horse-power. The army also has one aero company stationed in the Philippines for

coast defense work. It will be raised to aero squadron strength."

General Orders No. 55 provided that the Reserve Officers of the Aviation Section of the Signal Corps should consist of 296 officers. An order issued September 8, 1916, limited the number of National Guard Officers to be trained in aviation at army schools to fifty.

On October 11, 1916, President Wilson authorized the creation of the Council of National Defense and appointed seven civilian members of the Advisory Committee of the Council, as follows: Daniel Willard; Samuel Gompers; Dr. Franklin H. Martin; Howard E. Coffin; Bernard Baruch; Dr. Hollis Godfrey; Julius Rosenwald.

On February 7, 1917, when it became known that the House Committee on Military Affairs in reporting the appropriation for Army aeronautics for the ensuing year had allowed only \$8,000,000 for equipment and \$1,000,000 for aeronautic stations, the Aero Club of America

started another campaign of public education to get the appropriation increased to a minimum of \$50,000,000 and to insure the training of 2000 aviators during 1917.

After a meeting of the National Advisory Committee on Aeronautics held March 20-31 an official statement was issued outlining the plans of the Army and Navy regarding the number of aviators to be trained and machines to be ordered, which read in part as follows:

"There are many estimates of our reasonable needs, and the one herewith presented has been prepared after conferences with as many men as could be reached who have experience or judgment qualifying them to express an opinion, and after obtaining as many data as possible from Europe.

"Tentative estimate of annual requirements of aeroplanes (assumed to be possible of accomplishment in 1916):

"Attached to an army of 1,000,000 men, 1,000 planes and 1,000 aviators.



This photograph shows the First Aircraft Production Board in its meeting room in the Munsey Building, Washington, D. C. From left to right: A. G. Cable, Secretary of the Board; R. L. Montgomery, Sidney D. Waldon, E. A. Deeds, Rear Admiral David W. Taylor, Chief of the Bureau of Construction and Repair, U. S. N.; Brigadier-General George O. Squier, Chief Signal Officer, U. S. A.; Howard E. Coffin, Chairman of the Board.



Officers at the Mineola aviation station. From left to right, sitting: Capt. R. L. Taylor, officer in charge of flying; Lt. Charles Reed, first aero reserve squadron; Capt. P. A. Carroll, first aero reserve squadron; Capt. Frank T. Coffyn, S. O. R. C.; Maj. W. G. Kilner, C. O., S. C. A. S., Mineola; Capt. S. W. Fitzgerald, Commanding officer; Capt. Henry, Adjutant, S. C. A. S., Mineola. From left to right, standing: Lt. Stroman, photographic department; Lt. Jones, training department; Lt. L. C. Ricker, quartermaster; Lt. W. P. Willetts, technical department; Lt. Olyphant, first aero reserve squadron; Lt. B. O. Watkins, supply department; Lt. D. R. Wheeler, supply officer; Lt. H. H. Simons, training department; Lt. Montaral, instructor detailed from French F. C.; Lt. Page, technical department.

“Attached to our fleet at sea, 200 planes and 200 aviators.

“For harbor and seaport defense, 800 planes and 800 aviators.

“Total, 2,000 planes and 2,000 aviators.

“For training pilots (worn out or broken), 2,000 planes and 400 aviators.

“Total, 4,000 planes and 2,400 aviators.”

Seven weeks after the United States' entry in the war, on May 21, 1917, there was created the Aircraft Production Board, in the Council of National Defense, the personnel of which was as follows: Howard E. Coffin, Chairman; Brig. Gen. George O. Squier, Chief Signal Officer, U. S. A.; Rear Admiral David M. Taylor, of the navy; S. D. Waldon; E. E. Deeds; and R. L. Montgomery.

The preliminary announcement of the Aircraft Production Board was as follows:

“We now believe America has started on the right road toward working out her destiny in the air and taking the place to which her capacity entitles her and which the world expects of her. We have been in constant touch for weeks with

the aircraft manufacturers on the problem of the quantity production of machines, and the Government authorities are already signing contracts for as many machines as our present appropriation permits. The United States can depend on a minimum of 3500 aircraft of all types for the first year, if Congress authorizes us to proceed. The program we now have in mind would provide for both training and combat machines.

“The country has made progress in developing aviators. Last month a group of army officers visited the training camp of the Royal Flying Corps at Borden, Ontario, one of the four camps established in Canada and the aviation school at Toronto, where cadets are trained under military discipline for the service. In these schools there has been incorporated the latest European experience in the development of this new art of the air.

“Our officers were deeply impressed with their observations, and as a result we called together here the heads of six prominent engineering schools which also have military training, and

made plans to establish a similar system in the United States. The six institutions are the Universities of California, Texas, Illinois, Ohio, Massachusetts Institute of Technology, and Cornell University. Three technical instructors from each of these places were sent to Toronto. They returned on May 8 after a comprehensive study of the course given there, prepared to teach it themselves. On May 10 these six engineering schools opened similar cadet aviation schools at their respective institutions. At the end of two months of this preliminary work, the cadet is given a final test to determine whether he shall go on to the aviation camp.

"The manufacturing capacity can easily be doubled the second year. A prominent British General has asserted that America's greatest contribution to the war will be aircraft and aviators. We believe that once started upon quantity production, American mechanical genius will overcome any present obstacles to the progress of the art."

The Deficiency Bill to provide for the Army's needs at that time carried an appropriation of only \$54,000,000 for aeronautics.

Appreciating the fact that the plans for the building of our Air Forces on a scale proportionate to the need were restricted by lack of prospects to get sufficient appropriations and believing that the American public would favor the adoption of a plan extensive enough to provide for the training and equipping of ten thousand aviators and sending tens of thousands of aeroplanes to the Allies, the Aero Club of America undertook to get public support for such a plan.

The campaign started a few days after the announcement of the Aircraft Production Board. The slogan "*We must Strike Germany Through the Air*" was adopted.

In the first statement Mr. Alan R. Hawley, the President of the Aero Club of America, pointed out that, "Germany's U-boat warfare and the necessity of keeping the German fleet bottled up are occupying the navies of the Allies and no decisive victory over the Germans is expected in naval actions in the near future. Likewise advances against the Germans on land

are slow, and Germany has seemed able so far to always throw new thousands of men and new lines of trenches and countless guns to meet the advance of the Allies. The only victories on the part of the Allies so far have been as a result of supremacy of the air, as a result of the matching of skilful, daring Allied aviators against German aviators and observation balloons; the recent British and Italian victories were preceded by countless aerial fights in which hundreds of aviators took part, and it was not until the skies had been cleared of German aviators and of German observation balloons—and the Germans were thereby deprived of the aerial eyes of the infantry, of the aerial scouts, and the Allies' aviators, being masters of the air, could follow the movements of the enemy and locate their batteries and their strongholds, that the victories became possible.

"While the United States is beginning to help substantially now, effective help of the kind that leads to permanent victory can only come at the end of months of preparation, and in considering in which way we can best prepare to help to achieve permanent victories it is found that the aerial branch of the service affords the greatest possibilities. British, French, Russian, Italian and American authorities who have studied the matter closely have come to the conclusion that the addition of 10,000 aviators to-day to the Allies' present aerial forces would insure blinding the German batteries and preventing German aviators from conducting operations over or near the Allies' lines. An additional 10,000 aviators would make it possible to conduct aerial raids on a large scale and to strike Germany in the most vital places, to strike hard enough to lead to permanent victories."

A billion dollar appropriation was urged for Army aeronautics. It soon became evident that the public favored the appropriation of this sum.

One of the most important factors in creating favorable public sentiment for this appropriation was the hearings held by the Senate Subcommittee on Military Affairs on the Shepard-Hulbert Bill to create a Department of Aeronautics. This brought forth the endorsement of leading authorities of not only the plan

to train thousands of aviators and build tens of thousands of aeroplanes, but also strong general endorsements of the Sheppard-Hulbert Bill.

The hearings began June 12th, and lasted for two weeks. Those who testified before the Senate Sub-Committee of the House of Representatives, and endorsed the plan to establish a Department of Aeronautics, were as follows: Rear Admiral Robert E. Peary; Major L. W. B. Rees, of the British Royal Flying Corps, member of the British Commission in the United States; Howard E. Coffin, Chairman, Aircraft Production Board; Brigadier General George O. Squier, Chief Signal Officer, U. S. A.; Alan R. Hawley, President, Aero Club of America; Henry Woodhouse, Henry A. Wise Wood, Augustus Post, Rear Admiral Bradley A. Fiske; Lieut. Rumsey and Lieut. Prince, members of the Lafayette Flying Corps; J. Bernard Walker; F. H. Allen, one of the Directors of the Lafayette Flying Corps; Major General Goethals; Joseph A. Steinmetz, President of the Aero Club of Pennsylvania.

The forceful statements made by these authorities were published daily by the press throughout the United States and brought out hundreds of editorials urging prompt action and large appropriations.

Brigadier General George O. Squier, the Chief Signal Officer of the Army, in endorsing the aerial preparedness program said, in part:

"The way to beat Germany is to flood the air with aeroplanes. Take the war out of the trenches and off the ground. Put it in the air."

On June 18th Secretary Baker came out for a vast air fleet.

"The War Department is behind the aircraft plans with every ounce of energy and enthusiasm at its command," said Secretary Baker.

"The aircraft program seems by all means the most effective way in which to exert America's force at once in telling fashion.

"We can train thousands of aviators and build thousands of machines without interfering in the slightest with the plans for building up our armies and for supplying the allies with food and munitions. To train and equip our armies and send them abroad will take time, however, and in the meantime we can be devoting to this

most important service vast quantities of productive machinery and skilled labor which otherwise could not be contributing to the nation's cause in full proportion to its capacity.

"The aircraft plans meet the demands of the situation. Under existing conditions of fighting, where the allies and the Germans are fighting on practically even terms as regards man power and aircraft, the addition which we can contribute to the allied air forces will be proportionately of far greater value than the immediate aid which we can furnish on land. According to the best obtainable information, there are about 7,000,000 men on the western front today. The addition of a few infantry units, while of great moral value, is of little use in forcing a decision. A few thousand trained aviators, however, with the machines for their use, may spell the whole difference between victory and defeat. The supremacy of the air, in modern warfare, is essential to a successful Army. America must make sure that the Allies and not Germany, secure the permanent domination of the air, and that within the year."

On June 22 President Wilson himself endorsed the movement, in the following letter to Secretary Baker:

The White House,
Washington.

My Dear Mr. Secretary:

I have your letter of yesterday about the production of aircraft and the training of men to operate them, and want to say that I am entirely willing to back up such a program as you suggest. I hope that you will present it in the strongest possible way to the proper committee of the Congress.

Cordially and sincerely yours,

(Signed) WOODROW WILSON.

Hon. Newton D. Baker,
Secretary of War.

A bill appropriating \$640,000,000 was introduced and passed the House of Representatives on July 14, without a dissenting vote. It passed the Senate on July 21, and was signed by President Wilson July 24.

The estimate showed that only \$363,000,000 was to be spent for aeroplanes, the rest going to pay for the service squadron, supply squadrons, training stations, machine guns, etc., and that

the number of aeroplanes to be ordered under that appropriation would be only about 22,000, a good portion of which would be training machines needed for the training of aviators.

The Aero Club of America thereupon immediately started a campaign to make known the necessity of an additional appropriation of \$1,000,000,000 to build the thousands of large warplanes needed to conduct major aerial operations against the German bases.

Being told that the shortage of tonnage would preclude shipping thousands of aeroplanes to France, the Aero Club started to develop plans for delivering the aeroplanes by flying them across the Atlantic.

Aircraft Board Created

It became evident that to get quicker action and remove confusion in the production of aircraft it would be best to have an Air Board with full authority, or better still, a separate Department of Aeronautics. The Aero Club of America had recommended the separate department of aeronautics in 1915, and urged it continuously ever since.

Getting an Air Board with sufficient authority the Aircraft Production Board and the Signal Corps were prompt in acting and carrying the plans into effect. Their work in establishing and putting into operation huge training aviation camps was extraordinary. Carrying out the aircraft production program was slower.

Among the most striking accomplishments were the developing of the "Liberty motor" designed by Messrs. J. C. Vincent and E. S. Hall, and the creation of the International Aircraft Standards Board with Mr. F. G. Diffin as chairman, was a step towards it. A bill to create the Air Board was introduced in the Senate by Senator Morris Sheppard of Texas and in the House of Representatives by Congressman Murray Hulbert of New York. It passed the Senate on September 12 and the House on September 26. It was signed by President Wilson on October 1st, 1917.

The act creating the Aircraft Board and the endorsements of Secretary Baker and Secretary

Daniels may be found in "Flying" for September, 1917.

Unfortunately the provisions contained in Section 4 and Section 5 of the Act confined this Board to a merely advisory capacity and prevented its getting an organization adequate to do the important work of building Air Forces extensive enough to cope with the fastly developing German Air Forces.

The following were appointed on the new Aircraft Board: Howard E. Coffin, chairman; Major-General George O. Squier; Colonel E. A. Deeds; Colonel R. L. Montgomery; Admiral D. W. Taylor; Captain Noble E. Irwin; Lieutenant-Commander A. K. Atkins; R. F. Howe, appointed November 6, 1917; and H. B. Thayer, appointed February 26, 1918.

While these plans were being made in the United States, two changes took place in the situation in Europe, as follows:

1. Aerial warfare became more and more intensified. Aerial combats became more numerous; the employment of aeroplanes to attack infantry and artillery formations grew more and more extensive; bombing at short- and long-distance range became an every-day matter. This greatly increased the number of aeroplanes in use, and more than quadrupled the percentage of casualties among aviators and the loss of aeroplanes due to different causes.

2. The Italian reverses and the Russian collapse brought about serious conditions, necessitating a much greater contribution in aircraft and aviators from the United States than was planned and greater speed in carrying out the plan. A committee of the Aero Club of America, headed by Mr. Alan R. Hawley, the president of the club, and including Congressman Murray Hulbert, Admiral Peary, and the writer, called on some of the Washington authorities to urge the necessity. We found the authorities divided in two groups: those who felt certain that Congress would give additional appropriations for aeronautics immediately after convening in December; those who believed the program under way to be sufficient to meet the changed condition, and would not consider increasing it.

It soon became apparent that the Russian and Italian reverses could have been prevented had those countries had about two hundred additional warplanes each, and that an auxiliary air fleet was needed to meet the swift manœuvres of the enemy. At the annual meeting of the Aero Club of America on November 12, 1917, the following resolution was adopted, which was transmitted to President Wilson; Secretary of War Newton D. Baker; Secretary of the Navy Josephus Daniels; Mr. Howard E. Coffin, the chairman of the Aircraft Board; and Major-General George O. Squier, the chief signal officer:

Whereas, The greatest difficulty of the Allies has been to move their forces fast enough to meet unexpected German attacks on weak points of the Allied lines, and to overcome the advantage which the Germans have of being able to transport large bodies of troops, ammunition and supplies from one point to another by interior lines; and

Whereas, It is evident that powerful warplanes afford the needed combination of power and mobility in a higher degree than do any other appliances, and that the recent occupation of the Baltic Islands by Germans and the Italian reverses in the province of Venetia could have been prevented if the Allies had been able to send a sufficient number of torpedoplanes and bombing aeroplanes to assist the Russians and Italians at the first evidence of danger; and

Whereas, It is generally accepted by the recognized authorities on aeronautics that aeroplanes can easily be built which can fly across the Atlantic and thereby solve the problem of delivering large units of aeronautic power to England, France, Italy and Russia, without dependence on ocean transportation, or interfering with it; and

Whereas, There are in the United States unutilized manufacturing facilities and resources which could build thousands of powerful warplanes during the coming year without interfering with the present aeronautical program of the Army and Navy; and

Whereas, These aeroplanes can conduct major aerial operations against the German fleet and U-boat bases, as well as against the German lines of communication and military industries and forces; be it

Resolved, That these facts be brought to the attention of the President, the Council of National Defense, the Secretary of War, the Secretary of the Navy, the Aircraft Production Board, and to the American public, through the press, and that the coming Congress be urged to expand the present aeronautical program by appropriating not less than \$1,000,000,000 for building an "Emergency Air Fleet" of huge warplanes, and

also appropriate \$1,000,000,000 to carry out a comprehensive aeronautic program of training aviators and building the tens of thousands of fighting, photography, artillery and contract patrol aeroplanes; dirigibles and balloons, which are needed to assure the Allies' supremacy in the air.

The \$1,032,294,260 Army Air Program

In December, 1917, were made public the Signal Corps estimates for 1919, in which was asked the sum of \$1,032,294,260 for aeronautics, including the following items:

Lighter-than-air equipment	\$8,171,000.00	\$279,388.27
Aeroplanes and seaplanes	235,866,000.00	6,240,634.55
Spare parts and accessories	47,173,200.00	752,930.96
Extra engines and spare parts ..	553,289,120.00	1,367,110.95
Maintenance, upkeep, and operation of aero squadrons	20,950,000.00	1,249,120.62
Aero stations, United States	20,400,000.00
Aero stations, Panama	5,420,000.00
Aero stations, Hawaii	4,420,000.00
Maintenance, repair, etc., buildings in Europe	9,127,000.00
Purchase of land	16,700,000.00
Warehouse and supply depots ..	5,595,000.00
Aviation clothing equipment	1,358,440.00
Expenses of officers, enlisted men, and civilians on special duty ..	67,200.00
Vocational training	120,000.00
Mileage to officers and traveling expenses of civilian employees ..	3,050,000.00
Development of new types of aeroplanes and engines	2,000,000.00	70,462.39
Schools of military aeronautics ..	8,050,000.00
Machine-guns for aeroplanes ...	77,475,000.00
Photographic equipment, material, etc.	3,405,500.00
Contingent expenses, office equipment, etc.	100,000.00
Construction	3,061,293.77
Leasing of land	77,512.13
Reserve officers and men	400,000.00
Anemometers, barographs, aviators' garments and other special accessories	2,841.45
Miscellaneous	358,314.90
Total aviation	\$1,032,294,260.00	\$14,159,351.89

PAY OF OFFICERS AND MEN

Pay of 11,941 officers	\$27,619,533.00
Aviation increase, officers	10,030,800.00
Additional pay for length of service, officers	100,000.00
Pay of 153,945 enlisted men	60,606,607.05
Aviation increase, men	4,916,800.00
Additional pay for length of service, men	150,000.00
Total	\$103,423,740.05

Long Delay in Extending Plans and Getting Appropriations Causes Trouble

It was most unfortunate that the necessity of extending the aeronautic program was not recognized and steps were not taken to extend the program in the autumn of 1917.

In official statements dated September 13 and 31, Secretary of War Newton D. Baker announced the creation of the Liberty Motor and the passing of its "final tests." On February 21, 1918, he announced that the first "American-built battleplanes" were en route for France.

In March and April, 1918, it was made public that the aircraft program was late by several months.

The following letter, written by Mr. Alan R. Hawley, president of the Aero Club of America, to President Wilson, on April 2, 1918, gives the status of the situation at the time, and the recommendations made to solve the problems:

My dear Mr. President:

A number of men who had applied for admission in the Air Service of the Army have advised the Aero Club of America that they have been notified by the Signal Corps authorities that no further enlistments are being accepted at this time.

As Secretary Baker's report, published recently, stated there were less than four thousand aviators under training, and knowing that it will take twenty thousand aviators to keep five thousand aviators on the fighting front continuously for one year, and realizing that to lack the trained aviators to supply the necessary replacements would mean defeat for the cause of the Allies, we were amazed to find this condition.

In answer to our inquiries, we were advised that the reason no further enlistments are accepted for the Air Service is that there is a lack of training fields and of aeronautic equipment and that these cannot be provided because there are no funds available for the extension of the Air Service.

This is only one of the evidences that the aircraft program is slowing down because of lack of funds. We have been advised by factories that have completed their orders that they also do not have orders to look forward to and to prepare.

We submit, Mr. President, that this is a mournful condition which threatens the cause of the Allies more seriously than anything else. Supremacy in the air is to be the key to victory. To achieve and maintain supremacy in the air, the Allies must be able to count on not less than twenty-five thousand American aviators, so as to insure keeping five thousand at the front continuously for the various duties of the Air Service and for the bombing expeditions.

The percentage of replacements needed in the Air Service has increased greatly in the past six months and will further increase in the coming year, because there is much more aerial fighting, attacking troops from the air, bombing at low altitudes and night raiding. Aerial fighting is becoming more and more intense; and the anti-aircraft guns are firing more and more accurately and hitting aeroplanes at altitudes of sixteen thousand feet. This increases the casualties among aviators enormously.

This condition to-day is analogous to the condition which existed last October in the American aircraft situation as a whole. A large number of training camps had been established, at a cost of \$390,000,000, orders for aeroplanes and motors had been placed, and the funds had practically been exhausted. Thereupon the work of developing additional sources of supplies for aircraft and motors practically stopped, notwithstanding the fact that the Italian reverses and the Russian collapse demanded imperatively that our program be tripled in size.

The Aero Club of America officials urged and pleaded for prompt consideration of this new condition at the time, and pointed out that it was absolutely necessary to immediately give two billion dollars additional appropriations for extending the aircraft program. That was six months ago, when prompt

action would have prevented the confusion and mistakes which were subsequently made, partly owing to lack of sufficient appropriations.

The main cause of the present deplorable condition of our aircraft program was that the authorities in charge tried to make twenty thousand aeroplanes do the work of eighty thousand. The original program did not take into consideration that it takes an average of two aeroplanes to give an aviator the one hundred hours of preliminary and advanced training needed to make him fit for the present-day highly specialized work of a military aviator. Nor did it take into consideration that it takes close to one hundred per cent. replacements per month in aeroplanes and motors to keep aviators equipped for fighting. Nor did it take into consideration that it takes forty per cent. replacements in aviators per month to keep up the fighting personnel of aero squadrons.

In making this program the fact was overlooked that if the plan was to keep five thousand American aviators at the front, it was necessary to train twenty-five thousand. Therefore, there would be required fifty thousand preliminary and advanced training aeroplanes with which to train them speedily. The number of aeroplanes under construction to-day is not sufficient to even give the preliminary and advanced training to the number of aviators the United States must supply within the coming twelve months.

There was also overlooked the fact that to keep five thousand aviators equipped for action, there would be required an average of two thousand aeroplanes of different types per month, or a total of twenty-four thousand machines of different types during the twelve months.

Having overlooked these very important considerations, the authorities could not undertake to supply all the aeroplanes needed out of the twenty-two thousand planned. The Italian and Russian reverses created imperative needs, and the authorities received cables requesting thousands of aeroplanes of different types. Lacking the funds necessary to place additional orders, the authorities changed the orders of aeroplanes under construction, so as to meet the requests from France. As the requests from France and the suggestions from the different Allies were for different types of machines, the authorities kept on changing the orders, so as to supply these machines for which there seemed to be the most pressing need. This led to the continuous changes which caused the set-backs which have resulted in the aircraft program—which is still the same program made at the time when Italy was victorious and Russia was still fighting—being behind by several months.

Had the authorities been in a position to place additional orders whenever they received cables asking for a given number of machines of a given type, instead of having to change orders for machines under construction, to-day the original program would be nearly delivered and an additional program would be well under way.

To-day we are making the same mistake that was made then. We are stopping the enlisting of aviators and no steps have been taken to extend the program to meet the new conditions which have arisen, and which, unless they are met promptly, may result in Allied reverses and public condemnation of your Administration, not only from the American public but also from the Allies.

It is tragic to us, Mr. President, to know that while aeroplanes and aviators are needed so badly to fight this fight for civilization and humanity, hundreds of manufacturers who could be making aeroplanes and motor parts are kept in forced idleness for lack of orders, and thousands of patriotic young men who are anxious to join the Air Service and go to France and do their share towards winning the war, are told that no further men are being taken in the Air Services.

The delay in producing the Liberty motor cannot be held responsible for not giving preliminary and advanced training to aviators. This training, which includes cross-country flying, bomb-dropping, shooting at moving targets from aeroplanes, could be given with existing types of machines and motors.

We submit, Mr. President, that action must be taken promptly.

We agree with the members of Congress who advise us that those in charge of the present aircraft program have failed to make good and that it is hardly possible to expect better from

the same organization if conducted by the same authorities on the present plan of action.

We have followed the aircraft program step by step and are familiar with the inside problems that have caused the delays. These causes are numerous, but the main ones are:

(1) Lack of concentrated responsibility, authority and control in the management of aerial matters.

(2) Lack of sufficient appropriations to extend the aircraft program to meet the military needs of the Allies;

(3) Lack of touch between the authorities dealing with the strategic side of the war and the authorities having charge of the supplying of aircraft and aviators needed to build American and Allied air forces.

(4) The lack of a Government department having the authority and organization necessary to deal with all aircraft matters and prevent delays due to division of responsibility, bureaucratic jealousies and officials over matters of departmental jurisdiction, duplication of efforts, etc. The present Aircraft Board is only an advisory board and has no power to act or to get the necessary organization to extend or carry out an extended aircraft program.

To correct the situation, two successive steps must be taken, as follows:

(1) The immediate appointment of an Assistant Secretary of War and an Assistant Secretary of the Navy to represent the Army and Navy, respectively, in the Aircraft Board. This is to solve the immediate problems while the second step is being taken.

(2) The creation of a Department of Aeronautics, based on the British plan, which places the Air Services under a separate Department of Aeronautics, the head of which is independent of, although cooperating closely with, the War and Navy Departments.

The British Government went through every one of the troubles we have gone through in connection with our air service. The official reports of the investigation of the British Air Service in 1916 shows that there were scandals and charges, counter-charges and confusion, just as we have in the United States today. After three years of trying different plans, the military and naval authorities and other branches of the British Government came to the conclusion that the only solution was a separate Department of Aeronautics, with an Air Minister at the head, whose functions are identical with the duties of the War Minister and the First Lord of the Admiralty.

A separate Department of Aeronautics is the only solution to all the problems of building the air forces needed to win the war.

We must add that many of the officials in charge of the aircraft program and the members of their staffs are able men who, if placed in a Department of Aeronautics and given the power necessary to act and to get together an efficient organization, and the necessary funds, will quickly save the situation and enable the United States to do its share in the air this year.

It is well to add that an important consideration that led to the creation of the Air Ministry in Great Britain was the knowledge that Germany is planning extensive aerial mail, express and

passenger transportation lines, to employ the output of her aircraft factories after the war. Germany's plans are extensive enough to employ tens of thousands of aircraft. This would give her a reserve air fleet large enough to blow England, France or Italy off the map overnight.

As was brought out in the House of Commons by Lord Montague, aircraft can be turned from vehicles of transportation to war machines by the simple process of substituting bombs as cargo. Any nation that overlooks this fact may pay dearly for it overnight.

We all hope, of course, that some agreement may be reached between the nations which will guarantee against such a horror, as the bombing of a nation out of existence overnight by another nation having tens of thousands of aeroplanes. But the present war has shown that hopes do not save nations from the outrages of aggressors. As a matter of fact, Germany's first air raids of Great Britain were conducted by Zeppelins, which were employed for passenger carrying before the war. So, while keeping our hearts in the right place, we must be ready to protect the Republic and the rights of Humanity and the Cause of Civilization. To do this will require direct control and supervision of military and commercial air fleets, and this can only be done by a well organized Department of Aeronautics.

In conclusion may we point out that in the past, events have always proven that our suggestions, which were termed as excessive by some people at the time they were made, were most conservative. We beg you to judge these recommendations accordingly.

Assuring you of the hearty cooperation of the Aero Club of America and its affiliated Aero Clubs and cooperating organizations, I beg to remain

Very truly yours,

(Signed) ALAN R. HAWLEY,
President, Aero Club of America.

Following a report on the aircraft situation made to President Wilson by G. Borglum, on March 12 the War Department announced the appointment of a committee on Aircraft Investigation, consisting of H. Snowden Marshall, Edward Wells, and Gavin McNab. This committee reported its findings to President Wilson in April. In the meantime the Senate Committee on Military Affairs investigated the aircraft situation and reported on April 10. This report was printed in full in "Flying," for May, 1918.

Memoranda:



The first flight, December 17, 1903, Orville Wright at the helm; Wilber Wright alongside of machine. Date, December 17, 1903. Time, 10:30 a. m., 12:00 m. First flight, twelve seconds. Longest flight, fifty-nine seconds. Wind velocity, twenty to twenty-five miles per hour. Weight of machine, 605 pounds. Total weight, with operator, 750 pounds. Power of motor, ten to twelve horsepower. Weight carried per horsepower, sixty-three pounds. Speed of motor in flight, 1020 r.p.m. Speed of propeller, 310 r.p.m. Spread of wings, forty feet, four inches. Length of chord, six feet, six inches. Total area of wings, 530 square feet. Area of elevator forty-eight square feet. Area of vertical rudder, twenty square feet.

CHAPTER XVIII

THE EVOLUTION OF MILITARY AVIATION

As a matter of history, the first aeroplane actually ordered by and constructed for a government was designed and built by Clément Ader, the French pioneer, in 1890-97. Monsieur Ader, an electrical engineer by profession, was an intense patriot, and after taking part in the Franco-Prussian War of 1870, thought France could have been saved from disaster by an air fleet. Thereupon he set himself to study the flight of birds, and having found an Indian bat that seemed easy to imitate, constructed a large bat-like craft, which he fitted with a 40 horse-power steam motor and two propellers. At the first trial in 1890, this machine, driven by its own propellers, is said to have left the ground in a jump. The French Government considered the craft of value, and engaged Ader on a program which included nothing less than the founding of an arsenal for the construction of flying machines, the establishment of an aviation school, and the creation of an aerial fleet. For this purpose a first appropriation of \$100,000 was made.

The expectation proved disastrous to Ader, for when he finished the first machine in 1897,

after six years of hard work, it did not fly and the authorities refused to further finance the enterprise.

Subsequently, in 1905-06, the French Government negotiated with the Wright brothers for the acquisition of their machine, but imposed a condition that it should be guaranteed to reach a height of 3000 feet. This was later modified to 1000 feet. The Wright brothers, with their usual caution, replied that they had never flown higher than 100 feet, and rather than promise what they did not care to prove, they let the negotiations drop. The demand itself shows that it was not suggested by actual knowledge of aeroplanes, but deduced from performances of balloons and dirigibles.

At about the time of Ader's experiment the British Government became interested enough to finance the experiment of Sir Hiram Maxim in England. This inventor constructed a large aircraft of the multiplane type, 120 feet from tip to tip, fitted with two steam-engines of 175 horse-power capacity, and weighing 7000 pounds. Like Ader's experiment, it was wrecked in the attempt to fly it, and the military

authorities, who had been expecting to get a practical craft out of the first experiment, were disappointed and withdrew their support.

In 1908 the Board of Ordnance and Fortifications of the United States Army directed Samuel P. Langley to construct a large-sized model of the "aerodrome" he had designed, and made an appropriation of \$50,000 to defray the cost of the experiment. Langley's machine was a tandem monoplane, 48 feet from tip to tip and 52 feet from bowsprit to the end of its tail. It was fitted with a 50 horse-power engine and weighed 830 pounds. Two attempts to launch it were made, one on October 7 and the other on December 8, 1903. On both occasions, according to reports, the "aerodrome" became entangled in the defective launching apparatus and was thrown headlong into the Potomac River, on which the launching trials were made. Following the last failure, when the "aerodrome" was wrecked, the press ridiculed the whole enterprise, and Congress refused to appropriate money for further experiments.

The first requisition for a military aeroplane, giving definite specifications of what the aeroplane should accomplish to be acceptable for military service, was made by the United States War Department in an advertisement issued December, 1907. This advertisement is a wonderful document. It exacted the utmost, without going into the impossible. It shows that at that time—when Bleriot, Farman, and Curtiss had only made a few jumps, and the performances of the Wrights had not been made public—the authorities at Washington had a thorough knowledge of the aeroplane and a lucid conception of its possibilities. The full text of the advertisement is reproduced herewith for its historical value:

Signal Corps Specification, No. 486

ADVERTISEMENTS AND SPECIFICATION FOR A
A HEAVIER-THAN-AIR FLYING MACHINE

To the public:

Sealed proposals, in duplicate, will be received at this office until 12 o'clock noon on February 1, 1908, on behalf of the Board of Ordnance and Fortification for furnishing the

Signal Corps with a heavier-than-air flying machine. All proposals received will be turned over to the Board of Ordnance and Fortification at its first meeting after February 1 for its official action.

Persons wishing to submit proposals under this specification can obtain the necessary forms and envelopes by application to the Chief Signal Officer, United States Army, War Department, Washington, D. C. The United States reserves the right to reject any and all proposals.

Unless the bidders are also the manufacturers of the flying machine, they must state the name and place of the maker.

Preliminary.—This specification covers the construction of a flying machine supported entirely by the dynamic reaction of the atmosphere and having no gas bag.

Acceptance.—The flying machine will be accepted only after a successful trial flight, during which it will comply with all requirements of this specification. No payments on account will be made until after the trial flight and acceptance.

Inspection.—The Government reserves the right to inspect any and all processes of manufacture.

GENERAL REQUIREMENTS

The general dimensions of the flying machine will be determined by the manufacturer, subject to the following conditions:

1. Bidders must submit with their proposals the following: (a) Drawings to scale showing the general dimensions and shape of the flying machine which they propose to build under this specification. (b) Statement of the speed for which it is designed. (c) Statement of the total surface area of the supporting planes. (d) Statement of the total weight. (e) Description of the engine which will be used for motive power. (f) The material of which the frame, planes, and propellers will be constructed. Plans received will not be shown to other bidders.

2. It is desirable that the flying machine should be designed so that it may be quickly and easily assembled, and taken apart and packed

for transportation in army wagons. It should be capable of being assembled and put in operating condition in about one hour.

3. The flying machine must be designed to carry two persons having a combined weight of about 350 pounds, also sufficient fuel for a flight of 125 miles.

4. The flying machine should be designed to have a speed of at least 40 miles per hour in still air, but bidders must submit quotations in their proposals for cost depending upon the speed attained during the trial flight, according to the following scale:

40 miles per hour100 per cent.
39 miles per hour 90 per cent.
38 miles per hour 80 per cent.
37 miles per hour 70 per cent.
36 miles per hour 60 per cent.
Less than 36 miles per hour	rejected.
41 miles per hour110 per cent.
42 miles per hour120 per cent.
43 miles per hour130 per cent.
44 miles per hour140 per cent.

5. The speed accomplished during the trial flight will be determined by taking an average of the time over a measured course of more than five miles, against and with the wind. The time will be taken by a flying start, passing the starting point at full speed at both ends of the course. This test is subject to such additional details as the Chief Signal Officer of the army may prescribe at the time.

6. Before acceptance a trial endurance flight

will be required of at least one hour, during which time the flying machine must remain continuously in the air without landing. It shall return to the starting point and land without any damage that would prevent it immediately starting upon another flight. During this trial flight of one hour it must be steered in all directions without difficulty, and must be at all times under perfect control and equilibrium.

7. Three trials will be allowed for speed as provided for in paragraphs 4 and 5. Three trials will be for endurance, as provided for in paragraph 6, and both tests must be completed within a period of thirty days from the date of delivery. The expense of the tests is to be borne by the manufacturer. The place of delivery to the Government and trial flights will be at Fort Myer, Virginia.

8. It should be so designed as to ascend in any country which may be encountered in field service. The starting device must be simple and transportable. It should also land in a field without requiring a specially prepared spot and without damaging its structure.

9. It should be provided with some device to permit of a safe descent in case of an accident to the propelling machinery.

10. It should be sufficiently simple in its construction and operation to permit an intelligent man to become proficient in its use within a reasonable length of time.

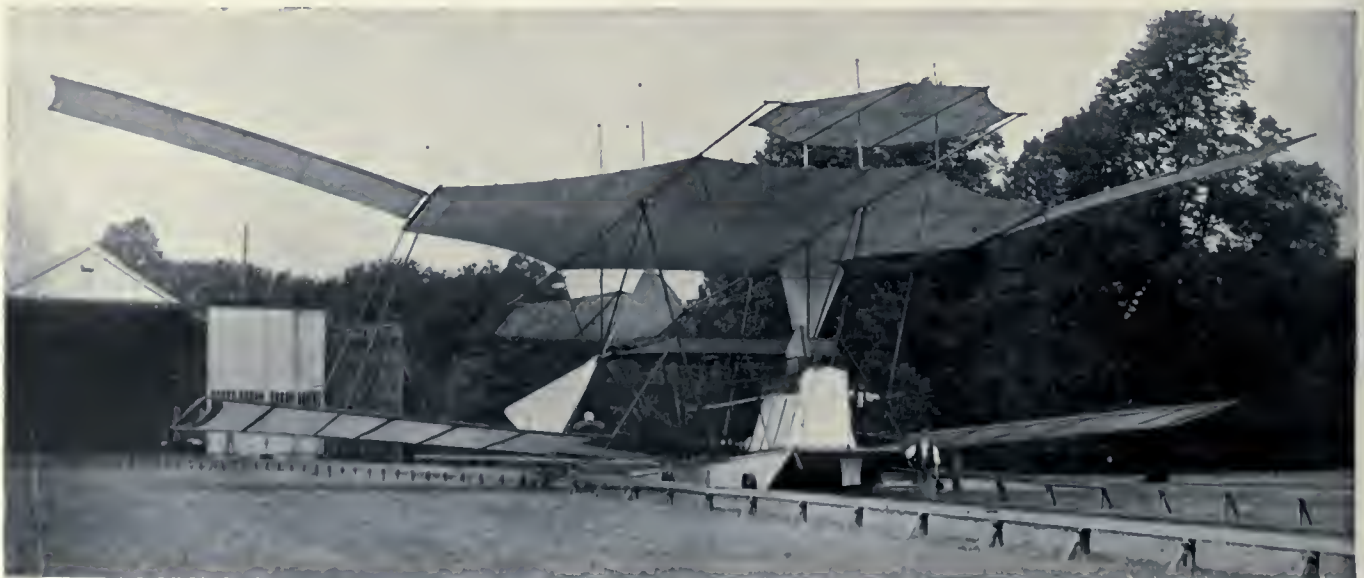

Next the British Government engaged Sir Hiram Maxim to build a military aeroplane. Sir Maxim's multiplane also came to grief in an attempt to show its flying qualities.

11. Bidders must furnish evidence that the Government of the United States has the lawful right to use all patented devices or appurtenances which may be part of the flying machine, and that the manufacturers of the flying machine are authorized to convey the same to the Government. This refers to the unrestricted right to use the flying machine sold to the Government, but does not contemplate the exclusive purchase of patent rights for duplicating the flying machine.

12. Bidders will be required to furnish with their proposal a certified check amounting to ten per cent. of the price stated for the 40-mile speed. Upon making the award for this flying machine, these certified checks will be returned to the bidders, and the successful bidder will be required to furnish a bond, according to army regulations, of the amount equal to the price stated for the 40-mile speed.

13. The price quoted in proposals must be understood to include the instruction of two men in the handling and operation of this flying machine. No extra charge for this service will be allowed.

14. Bidders must state the time which will be required for delivery after receipt of order.

JAMES ALLEN,

Brigadier-General, Chief of Signal Officer of the Army.

SIGNAL OFFICE,

Washington, D. C., December 23, 1907.

The Wright brothers were the only persons to submit a complete machine and fulfil the requirements. The first trials, made by Orville Wright at Fort Myer in September, 1908, resulted in a record flight of 1 hour, 14 minutes, 20 seconds. An accident prevented the fulfilment of the passenger-carrying requirement and caused a delay of one year.

The Wright machine, which fulfilled the conditions in August, 1909, was the old-type Wright biplane. It had a spread of 40 feet, a 25 horse-power motor, front elevator, skids instead of wheels, and was started by catapult and monorail. The record flights made during the tests at Fort Myer included a flight of 1 hour, 20 minutes, 30 seconds, and one of 1 hour, 23

minutes, 20 seconds, with Lieutenant Frank P. Lahm as passenger.

It was most appropriate that the distinction of supplying the first aeroplane to the United States Government should have gone to the Wrights, who gave the world the first practical aeroplane. Wilbur Wright and his brother, Orville Wright, two men of remarkable characteristics, sons of the Rev. Milton Wright, were presented in their boyhood, thirty odd years ago, with a toy helicopter, a butterfly-shaped contrivance, consisting of paper wings fitted with a tin propeller which, when made to revolve by twisted rubber, caused the toy to shoot forward through the air. That toy fired their imagination, and they saw it, in magnified form, capable of carrying a man.

Their attempt to fly large helicopters constructed on the idea of the toy did not bring practical results, and until 1896 they did not give the matter of artificial flight more than passing attention. In the summer of that year, however, the news of the accident and death of Otto Lilienthal, the German champion of gliding flight, stirred them to action, and they set themselves to study aerodynamics and the works of Lilienthal, Mouillard, Chanute, Maxim and Langley, the most prominent experimenters at that time.

Their experiments with a glider began in the autumn of 1900 at Kitty Hawk, North Carolina. There, on the barren sand-dunes of North Carolina, these two intrepid investigators took all the theories of flight and tried them one by one, only to find after two years of hard, discouraging work, that they were based more or less on guesswork. Thereupon they cast aside old theories and patiently put the apparatus through innumerable gliding tests, ever changing, adding, and modifying. They set down the results after each glide, comparing and changing details again and again, advancing inch by inch, until they at last developed a glider wonderfully exact, which, when fitted with a light motor also built by them, made initial flights on December 17, 1903, of from twelve to fifty-nine seconds' duration. This, then, was the birth of the aeroplane,—the flimsy, iconoclastic thing which seems to evade Newton's



The first "gun-plane" was the French Voisin armored and armed with a 37 mill. gun, tested early in 1914. It disproved the theory that the recoil of a gun would upset the aeroplane.

laws, eliminates frontiers, and promises to expand civilization as much as have the steamship, the railway, and electricity.

On September 15, 1904, Orville Wright, flying the Wright biplane near Dayton, Ohio, made the first turn in a heavier-than-air machine. On September 20, he made the first circle; on October 4, 1905, he made the first flight of over half an hour, a flight lasting 33 minutes, 17 seconds.

The Wrights did not make their achievements public at the time; in fact, until 1908 they flew only in private.

The report of their wonderful achievement, nevertheless, spread far and wide. It stimulated those who had given up experimenting and inspired others to take up experiments. Octave Chanute, in 1902, went to France and related the early successes of the Wrights with their glider, describing the general shape of the Wright machine. The result of this trip was that half a dozen enthusiasts, including Louis Blériot, Captain Louis Ferber, Ernest Archdeacon, and later the Voisin brothers and Alberto Santos-Dumont, took up the work, thus founding the mighty French school, which has increased so greatly and done so much ever since. The first member of this school to succeed was Santos-Dumont, the Brazilian aeronaut sportsman. He constructed a machine of original design, and in 1906 made short sustained flights of from fifty to seven hundred feet in a straight line. This created a world-wide sensation at

the time. Meanwhile, others of the French school graduated and won honors. The Voisin brothers became constructors and teachers, and with their cooperation Leon Delagrangé, Henry Farman, Louis Blériot, and others, prosecuted practical experiments and succeeded in getting their creations to leave the ground for modest flights. At this juncture, during the summer of 1908, the Wrights started to give public demonstrations. Their methods supplied and suggested to the French experimenters the means to modify and improve their aeroplanes, particularly the method of balancing them, which had, until then, been a perplexing problem.

The conditions set by the United States Government in its specification of 1907-08 formed the standard by which most governments judged aeroplanes acquired for military work until the close of 1911, when the French Military Competition took place. This competition was organized by the French War Department at the close of 1910, after the military manœuvres, with a view to develop better aeroplanes for military purposes. The conditions to be fulfilled by the competing aeroplanes and the prizes to be awarded to the winners were as follows:

General Conditions of French Military Competition of 1910-1911

1. The aeroplane and its engine must have been constructed in France of the best materials.

2. Each aeroplane must make a circular flight of 300 kilometers (186 miles) without a stop.

3. Each aeroplane on this circular flight must carry a load of 300 kilograms (660 pounds) over and above the requisite petrol, oil, water, etc.

4. Machines must provide accommodation for three passengers: the pilot, a mechanic, and an observer.

5. The mean speed must be not less than 60 kilometers per hour (37.3 miles).

6. Machines must be able to land without difficulty or damage on plowed fields, meadows, stubble, etc., and must start again from ground of this character.

7. Machines must be easily transportable, whether packed or not, by road or rail, and should be easily assembled.

The following hints were given to constructors:

1. It is desirable that the aeroplane be fitted with a double control; or, at all events, that the pilot and his assistant should be able to relieve one another by taking over the control in flight.

2. It is desirable that machines should be capable of starting without outside assistance.

3. The observer's field of vision should not be obstructed by any parts of the machine.

PRELIMINARY TESTS

1. Three flights must be made with the above stated load on board, and a landing accomplished on ground of the nature indicated in paragraph 6 above. On each occasion machines must reascend, start from the ground and land again after a flight of a few minutes.

2. The machine carrying its full load must make a flight over a circular course for the purpose of testing its speed.

3. Two altitude flights, with the full load, must be made, during which machines must reach a height of 500 meters (1640 feet) within 15 minutes.

TWO FINAL TESTS

On a day appointed beforehand all the machines that have successfully passed the preliminary tests shall make a non-stop flight over a circular course of 300 kilometers (186 miles)

with their full load. The final classification will be made according to the best performance during this test.

PRIZES

The prizes will be awarded as follows: The machine accomplishing the best performance will be bought by the Ministry of War for the sum of 100,000 francs and its constructor will receive an order for 10 machines of a similar type at 40,000 francs each. An extra premium of 500 francs will be granted in addition for each kilometer of average speed above 60 kilometers per hour that the machine has attained. The constructors of the machines accomplishing the second and third best performances will receive orders for six and four machines respectively, at the same prices. In the case where only two machines come through the tests satisfactorily, the constructor of the first will receive an order for twelve machines and the constructor of the second an order for eight machines; and if only one machine has satisfactorily passed the tests its constructor will receive an order for 20 machines.

The general conditions of this contest were



How they tried to shoot over the propeller up to 1915, before the method of synchronizing the gun with the propeller to permit shooting through it was found, a French improvement.



French Caudron biplane equipped with two motors. (Official French photo.)

over 100 per cent. more severe and more detailed than the general conditions of the American competition. The aeroplane had been tried in the military manœuvres of 1910, and from its accomplishments the authorities had deduced its great possibilities—if further developed—to give the amount and quality of service exacted as minimum in the competition. The conditions show that the authorities had a thorough knowledge of what an aeroplane would have to do to suit for general military work, and the large prizes offered show that they were aware that to develop the required standard efficiency was to involve lengthy and costly experiments, which few of the constructors could carry out unless a liberal inducement was given. As it was, the contest had to be postponed for six months to give an opportunity to constructors to develop the required qualities.

Encouraged by the inducements given, sixteen French constructors built special aeroplanes, thirty-four in number, whose general characteristics were as follows:

Make	Type	Span	Length	Motor	H.P.	Weight Kilo.
Antoinette	Monoplane	52' 6"	35'	Antoinette	60	935
Astra	Biplane	40'	34' 3"	Chenu	75	862
"	Triplane	43'	31'	Renault	75	760
Astra-Wright	Biplane	52'	34'	"	50	624
Blériot	Monoplane	36'	27'	Gnome	100	465
"	"	36'	27'	"	130	515
Bréguet	Biplane	53'	29'	"	100	652
"	"	41' 4"	28' 6"	"	130	637
"	"	41' 4"	25' 6"	"	100	652
"	"	53'	29'	Dansette	110	722
"	"	41' 4"	28' 6"	Canton-Une	110	703
"	"	53'	29'	"	80	700
Deperdussin	Monoplane	40' 6"	30'	Gnome	100	452
"	"	39' 6"	30'	Anzani	80	
"	"	40' 6"	30'	Clerget	100	526
H. Farman	Biplane	64'	38'	Renault	75	691
"	"	64'	32' 6"	"	75	691
"	"	52' 10"	32'	Gnome	70	
"	"	52' 10"	32'	"	100	471
M. Farman	"	64'	37' 8"	Renault	75	689.5
"	"	64'	33'	"	75	
Goupy	"	41'	33'	Chenu	75	618
"	"	44'	33'	Gnome	100	637
Morane-Borel Monoplane				"	130	

Make	Type	Span	Length	Motor	H.P.	Weight Kilo.
Nieuport	"	41'	29'	"	100	483
"	"	41'	29'	"	100	483
Paulhan	Triplane	41' 6"	33'	Renault	75	
R. E. P.	Biplane	36'	33'	R. E. P.	60	
Savary	"	62'	38'	Labor	70	708
"	"	62'	38'	"	70	708
Voisin	"	48'	33'	Gnome	130	622
"	"	48'	33'	Renault	75	674
"	"	48' 8"	33'	"	75	674
Zodiac	"	48'	32'	"	75	674

The final tests were held over the 300-kilometer course from Rheims to Amiens. Adverse weather conditions made these tests much harder than they should have been otherwise, but helped the aviators to show the good qualities of their machines. Eight passed the tests successfully. The machines, pilots, and speed attained were as follows:

Pilot	Machine	Motor	Time for 300 Kilometers	Av. Speed
Weyman	Nieuport ¹	Gnome	2 hrs. 33' 53 $\frac{3}{5}$ "	116.976
Moineau	Bréguet ²	Gnome	3 hrs. 9' 16 $\frac{2}{5}$ "	95.1
Prevost	Deperdussin ¹	Gnome	3 hrs. 21' 5"	89.515
Bregi	Bréguet ²	Gnome	3 hrs. 26' 47"	87.047
Fischer	H. Farman ²	Gnome	3 hrs. 33' 5"	84.474
Barra	M. Farman ²	Renault	3 hrs. 56' 13 $\frac{1}{5}$ "	76.196
Renaux	M. Farman ²	Renault	4 hrs. 8' 40"	72.38
Frantz	Savary ²	Labor	4 hrs. 27' 48"	67.210

¹ Monoplane.

² Biplane.

Thus in the short space of two years the military aeroplane had been developed mechanically from an experiment to a thing which gave service of a kind which no other instrument or mechanism could give. Its possibilities had been defined and its purposes had been extended—and made it a valuable military unit.

Following the French military competition England, Germany, and Austria, organized competitions of similar character. England, who had not until then taken steps to introduce aviation in the military establishment, organized a competition to take place during the year 1912, whose conditions were close to 100 per cent.

more severe than the conditions of the French military contest, as follows:

The prizes to be awarded by the War Office on the recommendation of a Committee, which will judge the tests and will decide whether any machine submitted is to be subjected to any test.

A.—Prizes open to the world for aeroplanes made in any country:

First prize. .£4,000 Second prize. .£2,000

B.—Prizes open to British subjects for aeroplanes manufactured wholly in Great Britain, except the engines:

First prize. .£1,500 Two 2d prizes. .£1,000

Three 3d prizes. .£500 each

No competitor to take more than £5,000. The War Office to reserve the right to vary the proportions of totals under A and B between the various prizes if the merits of the machines warrant it, or to withhold any prize if there is no machine recommended for it by the Testing Committee.

The War Office to have the option of purchasing for £1,000 any machine awarded a prize.

The owners of 10 machines which are submitted to all the flying tests and are not awarded a prize to receive £100 for each machine so tested.

Oil and petrol to be supplied free for the tests.

The place of delivery of aeroplanes entered for the competition will be announced later.

The following conditions are those required to be fulfilled by a military aeroplane:

1. To be delivered in a packing case suitable for transport by rail and not exceeding 32 ft. 9 ft. by 9 ft. The case must be fitted with eye-bolts to facilitate handling.

2. Carry a live load of 350 lbs. in addition to its equipment of instruments, etc., with fuel and oil for 4½ hours.

3. Fly for three hours loaded as in Clause 2 and maintain an altitude of 4500 ft. for one hour, the first 1000 ft. being attained at the rate of 200 ft. a minute, although a rate of rise of 300 ft. per minute is desirable.

4. Attain a speed of not less than 55 m.p.h. in a calm loaded as in Clause 2.

5. Plane down to ground, in a calm from not

more than 1000 ft. with engine stopped, during which time a horizontal distance of not less than 6000 ft. must be traversed before touching.

6. Rise without damage from long grass, clover, or harrowed lands in 100 yards in a calm, loaded as in Clause 2.

7. Land without damage on any cultivated ground, including rough plowed, in a calm, loaded as in Clause 2, and pull up within 75 yards of the point at which it first touches the ground when landing on smooth turf in a calm. It must be capable of being steered when running slowly on the ground.

8. Be capable of change from flying trim to road transport trim, and travel either on its own wheels or on a trolley on the road; width not to exceed 10 ft.

9. Provide accommodation for a pilot and observer, and the controls must be capable of use either by pilot or observer.

10. The pilot and observer's view of the country below them to front and flanks must be as open as possible, and they should be shielded from the wind, and able to communicate with one another.

11. All parts of aeroplane must be strictly interchangeable, like parts with one another and with spares from stock.

12. The maker shall accurately supply the following particulars, which will be verified by official test: (a) The h.p. and the speed given on the bench by the engine in a six hours' run. (b) The engine weight, complete (general arrangement drawing), and whether air or water-cooled. (c) The intended flying speed. (d) The gliding angle. (e) Weight of entire machine. (f) Fuel consumption per hour at declared h.p. (g) Oil consumption per hour at declared h.p. (h) Capacity of tanks.

13. The engine must be capable of being started up by the pilot alone.

14. Other desirable attributes are: (a) Stand still with engine running without being held. Engine preferably capable of being started from on board. (b) Effective silencer fitted to engine. (c) Strain on pilot as small as possible. (d) Flexibility of speed; to allow of landings and observations being made at slow speeds if required, while reserving a high acceler-

ation for work in strong winds. (e) Good glider, with a wide range of safe angles of descent, to allow of choice of landing places in case of engine failures. (f) It is desirable that the time and number of men required for the change from flying trim to road trim, or packed for transport by rail, and vice versa, should be small, and these will be considered in judging the machine. The time for changing from road trim and packed condition to flying trim to include up to the moment of leaving the ground in flight, allowance being made for difficulty in starting engine. (g) Stability and suitability for use in bad weather, and in a wind averaging 25 miles per hour 30 ft. from the ground without undue risk to the pilot. Stability in flight is of great importance. (h) The packing case for rail transport to be easily dismantled and assembled for use, and when dismantled should occupy a small space for storage.

The Kaiser's Prize for a Motor Competition

Until the French military competition, Germany had done little to develop aviation. She had concentrated all her efforts on the large dirigibles, and the only aeroplanes in Germany, with the exception of the Etrich type, were French types or copies of French and Wright types.

But German aviators in the military manoeuvres of 1911 clearly demonstrated the value

of aviation, and Prince Henry of Prussia, who had hitherto sponsored aviation without support, urged an appropriation of \$7,500,000 for aviation. As a result of the good work of the German aviators, on January 27, 1912, the Kaiser offered a prize of 50,000 marks to encourage the development of German aeromotors. The letter offering the prize read as follows:

To develop aviation in Germany, I desire to offer, out of my private purse, a prize of 50,000 marks, to be given on the occasion of my next patron saint's day, January 27, 1913. The contest, examination, and tests will be arranged and conducted by a committee composed of members of the Imperial Automobile Club, Imperial Aero Club, members of the German Automobile Constructors' Association, and delegates of the Imperial Office of the Interior, the Navy, War Department, Department of Public Instruction, and Polytechnic School of Berlin.

I write you to draw up and present to me the report of the finding of the committee by the beginning of January, 1913.

(Signed)

WILLIAM, I. R.

Berlin, January 27, 1912.

The offering of this prize was like a signal to the German nation to take up the work of aviation.

The Aerial League of Germany started a public subscription which brought in 7,234,506 marks. The purpose of the league was to train within the shortest time as large a number as possible of aviation pilots, to form a reserve, and to encourage the general development of avia-



Partial view of the 90 French aeroplanes which participated in the first military aeronautic review—held at Buc, France, in 1912.

tion in Germany. Following are some of the results obtained:

The number of pilots was 230 at the end of 1912; it increased to 600 by the end of 1913. The constructors of aeroplanes numbered less than 20 in 1912; they increased to 50 by the end of 1913. The developments due to the efforts of the Aerial League led the Reichstag to pass a bill providing for an expenditure of \$35,000,000 for military aeronautics during the next five years.

During the first month of 1914 inducements offered by the Aerial League of Germany led to the breaking by German aviators of all world records. By the middle of July the non-stop endurance record was brought up to 24 hours, 12 minutes, by Reinhold Boehm, and the altitude record to 26,246 feet, by Heinrich Oelrich. Over one hundred other records similar to the above were made. For instance, Basser and Landsmann made continuous flights of 18 hours, 11 minutes and 21 hours, 49 minutes, respectively. In one of these flights Landsmann covered 1335 miles, the longest distance ever traveled by man in one day. Among the records for altitude was that of 21,654 feet, made by Otto Linnekogel.

The secret of these successes was the motor,—a Mercedes,—developed as a result of the interest created by the Kaiser's prize.

Aeroplanes First Used for Military Purposes in the Italian-Turkish War

The first aeroplane to be used under conditions approximately warfare was the Wright machine belonging to Mr. Robert J. Collier. He was then president of the Aero Club of America, and loaned his machine to the United States Government for use on the Mexican border in 1911.

The first employment of aeroplanes in actual war was in Tripolitania, during the Italian-Turkish war in 1911.

French Aviation Developed by Public Interest

It was in 1910, that the late General Stephane Brun, French Minister of War, took steps to develop aviation in France. In so doing he

overruled the objections of his staff, who condemned the aeroplane as practically useless, and recommended concentration of effort on building dirigibles. Up to that time nothing had been done to develop military aviation in France.

During that year General Brun arranged for the participation of aeroplanes and dirigibles in the French military manœuvres, and also employed leading civilian aviators in these manœuvres. The innovation proved a great success and created tremendous public interest.

The manœuvres were followed by the "Circuit of Eastern France," which also was a great success. In that circuit the aviators covered a distance of 500 miles, accomplishing what was then considered impossible. The success of this circuit led to holding, in 1911, the Paris-Madrid Race, the Paris-Rome Race, the European Circuit, and the British Circuit, in all of which French aviators participated, carrying away the most important prizes. These circuits were followed by military manœuvres in which French aviators again gave a good account of themselves.

The Paris Aero-Show that winter was thronged by an enthusiastic, patriotic public which expressed its enthusiasm in many ways. At the time of the show an estimate was before the French Chamber of Deputies appropriating 11,000,000 francs for military aviation. That sum seemed insufficient to the enthusiastic patriots and they said so. The French Minister of War who had succeeded General Brun thought the sum sufficient, and explained that it was much more than had been spent the year before for this purpose. The patriots were not concerned with what had been done the year before; they wanted aeroplanes now, and wrote long letters to the newspapers. The press became interested and came out strongly in support of the demand for more aeroplanes, pointing to the splendid Salon show as an example of what French genius could do. People all over the country became interested and went to the Salon. The sight of fourscore aeroplanes exhibited there and contact with the airmen who had brought France new glory did the rest. Presently the provinces joined in the fight, and the Minister of War was just getting ready to



The first use of aeroplanes in war during the Italian-Turkish War. An Italian airscout is here shown starting on a scouting trip outside Tripoli, Feb., 1912.

reply to scores of memorandums from representatives of different departments when the ministry fell.

The advent of the new Minister of War, M. Alexandre Millerand, at this critical juncture was most propitious. M. Millerand believes in aviation. Though a Socialist, he is intently patriotic and believes that a nation should be well armed against contingencies. His first move was to announce his full sympathy with the movement and to increase the appropriation for military aviation to 3,000,000 francs. This settled matters and pleased all concerned. Things were about to quiet down when it became known that Prince Henry of Prussia had advocated an expenditure of \$7,500,000 for aviation, and that the Kaiser had offered a prize of 50,000 marks to encourage the development of German aeromotors.

Next it was made public that the makers of the Deperdussin monoplane, the military aeroplane with which Védrières and Prevost had just made two splendid records, and which Védrières had used to fly over the Chamber of Deputies and drop handbills reading, "Give France More Aeroplanes," had received a communication from a leading German concern. It was an offer to buy the rights to construct that machine in Germany, but advised that in case the offer

was declined the German firm would go ahead and construct the machine without permission.

These three events had a tremendous effect. It was accepted as a challenge from Germany. Old scores were brought up, and the old wounds of 1870 were reopened. But the result was not an outburst of antagonism, as might have been expected. Little time was spent in talking about the challenge. Interest turned at once to the matter of getting means to make France supreme in the line in which she leads—aviation.

On February 11, 1912 a meeting was held at the Sorbonne, which bids fair to become a historical event. It was held under the auspices of the Association Générale Aéronautique in order to devise plans to start a national movement to make France supreme in aerial matters, and was attended by the highest civil and military authorities. The meeting was open to the public, who poured in until the vast Sorbonne hall was packed to its capacity. The following report by the Frantz-Reichel, the French veteran reporter, gives an idea of what happened:

Representative Gabriel Bonvalot began speaking. With extended arms and a voice vibrating with patriotic emotion he made his appeal.

"France needs the fourth arm," said he, "and at once. The other side of the Rhine is preparing; it is the Emperor who has given the war-cry. Let us

prepare against this; let us unite our activities and efforts in a manifestation which will make our country supreme in aerial armament.

"I don't cry unto you: 'Help us!' I cry unto you: 'help yourself.' We must have aerodromes; we must have hangars, aeroplanes, and money. Let us take stock and let each give according to his resources. Little or much, gold or pennies,—it does n't matter. What we want is the manifestation of your love of country. Say, will you?"

The audience roared "Yes!" enthusiastically.

"Thanks," said he.

But he was unable to continue. The gathering was in uproar, and each person was busy taking stock of his resources.

The generals present gave their caps to the aviators, and the latter went up and down the aisles. But there were not enough caps, and the audience cried, "More, more!" Ladies then took the military aviators' caps and went around to collect. But again these proved not enough. As the crowd in the galleries was growing impatient, the military students took their own caps and went around.

Following this touching and curious scene, the collection was emptied on a table before the generals, senators and deputies, who made piles of the gold, silver, and copper, and added up the total. Gabriel Bonvalot rose again and said:

"You have given 2274 francs. This is well. But I have other good news to announce. While you were giving, others gave, and here is what the General Aeronautical Association has collected for the Committee of National Aviation. Listen! The Aerial Association of Picardie, 5000 francs; M. Jacques Balsan, at Chateauroux, one hangar; at Pau, another hangar for four aeroplanes and a house for twenty military aviators; the committee of Orleans, one aeroplane for the Fifth Army Corps; the committee of Cher and Prinee d'Arenberg, three aeroplanes; the committee of Picardie, one aeroplane; the committee of Charentes, 100 acres of land; the committee of Pointiers, two hangars and an aeroplane; M. Henry Deutsch, one aeroplane; and, finally, M. Michelin, 100,000 francs to pay for the apprenticeship of young men whose personal means do not allow them to put their courage at the disposal of the nation."

This announcement was received with a thunder of acclamations.

Captain Bellenger, the pioneer military aviator, representing the Minister of War, M. Millerand, spoke next. He demonstrated with the authority of an officer and an aviator the important rôle played by the aeroplane in war, and he recalled the painful experience of 1870, in order to make the people understand the lesson—understand that they had been defeated by the ignorance of the chiefs of the French army concerning the movements and plans of the enemy. He

recalled Weisseboyrg, Froeschwiller, and other painful instances, and showed that if similar circumstances recurred, they could not bring the same terrible consequences, provided France had aeroplanes in her army. He ended by quoting conclusive examples of the rôle played by the aeroplane in actual warfare in Tripoli.

Following him, Senator Reymond spoke on the necessity of giving France a strong aerial organization. Then M. Millevoy spoke of the great value of the aeroplane, of its convincing qualities in furthering peace and making France aerially supreme.

M. George Clemenceau, though an invalid forbidden by his doctor to take part in the event, was conquered by enthusiasm and, an invalid no longer, rose and passionately urged the people to assist in the national movement.

When, finally, the addresses were ended, Mlle. Vix of the Opéra sang an air from the "Vivandière," in which all joined. And thus ended this historic meeting.

On the day after the Sorbonne meeting the daily newspaper "Matin" started a national subscription with a contribution of 50,000 francs, an example at once followed by the "Petit Journal" and the "Petit Parisien," and subsequently by other publications throughout the country. Soon donations came from all sides. States, departments, cities, towns, villages, clubs and universities; political, educational, industrial, sportive, and social associations—all contributed. In most cases the plan of contribution was to give an army aeroplane which would bear the name of the state, department, or body making the gift. Large communities contributed as many as six aeroplanes. In some poor communities the inhabitants contributed five cents each; in others school-children contributed one cent each; in a home of destitutes the inmates offered to go without certain necessities to contribute a few cents each. Individual contributions varied in type from checks for 100,000 francs, given by some rich persons, to a month of services offered by a nurse who did not have any cash. They included songs written by *chansonniers* of Montmartre fame, and the statue "La Defense," donated by the famous sculptor, Rodin. Inside of a month's time the collected fund amounted to over 1,500,000 francs. The total of the French public sub-

scription at the beginning of the present war was 6,114,846 francs.

Board of Governors, Aero Club of America:

Gentlemen—As per authorization of your Executive Committee, dated May 19, 1915, and February 23, 1916, I have, with Messrs. Henry A. Wise Wood and Henry Woodhouse, attended to the affairs of the National Aeroplane Fund, and I take pleasure in presenting herewith a brief report of the work of the National Aeroplane Fund, and an audit of so much of the fund as passed through the hands of the Executive Committee of the Aero Club of America.

This audit shows that the sum of \$171,031.17 was received direct, \$147,314.92 of which was disbursed to carry out the purposes for which the money was subscribed. Of the balance, which amounts to \$23,716.25, the sum of \$20,876.76 is obligated for the \$20,000 set aside for the prizes for the National Aerial Derby, prizes for model aeroplane competitions, expenses for the National Aerial Coast Patrol Commission, etc.

In addition to the sum so subscribed, there were given to the National Aeroplane Fund aeroplanes and a course of training for militiamen and civilians, for the purpose of helping to build our aerial defenses, valued at \$94,000, which are not included with the cash subscriptions to the fund.

In addition, the funds, aeroplanes, and training secured for different states, in different ways, not shown on the books of the fund, but all being the direct result of the work of the administrators of the National Aeroplane Fund, and being valuable for what they contributed to the building of our aerial defenses, amounted to about \$109,300.

This makes the total cash value of the contributions secured through the efforts of the administrators of the National Aeroplane Fund, for the upbuilding of

our aerial defenses and developing our aeronautic resources, \$378,381.17. The value of resources developed is hard to estimate.

Furthermore, by means of the National Aeroplane Fund educational campaign, public interest was aroused to demand of Congress suitable appropriations for aeronautics in the Army, Navy, Militia, Aerial Reserve Corps and Coast Guard, which resulted in the appropriation for the different services of the sum of \$18,000,000.

As can be seen from the reports covering the different lines of activity developed by the National Aeroplane Fund, which was started in the spring of 1915, when American aeronautics was at its lowest ebb, the National Aeroplane Fund succeeded in developing aeronautics in the Army, Navy, National Guard, Naval Militia; among college men, in the Coast Guard, and a dozen other fields.

This movement was started in the early spring of 1915, after Congress had adjourned and the international situation grew serious enough to make this country take stock of its defenses. There were at the time only about a dozen aeroplanes in commission in the Army and Navy combined, when we should have had one hundred times that number, and there were no prospects of relief, since the last Congress had allowed but a fraction of the amount needed for aeronautics. The manœuvres of the National Guard and Naval Militia of the states were being planned, but in no case was an aeroplane to be employed—the reason being that there were no funds available to pay for aeroplanes or for training Militia officers in aviation.

The Aero Club of America, the National aeronautic body, which has fostered the development of aeronautics in America since 1905, realizing the necessity of bringing immediate relief, decided to wait no longer for the Government to do its duty. It took steps to contribute materially toward providing aeronautical



The first tractor biplane in America. Constructed by Captain James V. Martin in August, 1911. The first flight took place in November, 1911, at Nassau Boulevard, L. I. It was equipped with a 100 h.p. Gnome motor.

equipment and instituted the National Aeroplane Fund for the purpose of developing our aeronautical resources, organizing aviation units in the Militia of the States, building an aeronautical reserve, and creating in a general way sources of supply of personnel and equipment.

In the educational campaign, which was the backbone of the National Aeroplane Fund, which resulted in 2,000,000 pieces of literature being distributed during eighteen months, the committee has had the hearty coöperation of the press of the United States. We have received an average of sixty clippings a day regarding the work of the Aero Club of America during these eighteen months, including hundreds of editorials, not a single one of which spoke unfavorably of the National Aeroplane Fund or the work of the Aero Club of America.

The work of the National Aeroplane Fund has been highly commended by leading Congressmen and Senators, and was favorably mentioned on the floor of the House of Representatives. We have also been warmly praised by Washington officials, also by the governors and adjutants-general of the States and by hundreds of contributors to the fund, and others.

Some of the most important movements started or endorsed by the Executive Committee in connection with the campaign to develop our aerial defenses have been adopted and endorsed by the Administration and are as follows:

The Council of National Defense, which was advocated by the Aero Club of America and other organizations coöperating through the Conference Committee on National Preparedness in May, 1915, was adopted by Congress, and President Wilson has just appointed the seven civilian members of the council, which include two prominent members of the Aero Club of America.

The organizing of the Council of National Defense is undoubtedly the most important step taken so far to develop real national preparedness. This country as a nation has been like a house divided. There has been practically no coöperation between the Government, the industries, the patriotic organizations, and the people. So our enormous resources and extensive industries have never been coördinated as the best interests of the nation demand. The Council is to do the coördinating, and we expect that aeronautics will greatly benefit from the coördination of our aeronautical resources which the council may bring about.

The large appropriation asked by the Aero Club of America for aerial defense, which seemed excessive when it was proposed, as it was six times greater than the estimates submitted to Congress by the secretaries of war and the navy, was adopted by Congress, and close to \$18,000,000 was allowed for aerial defense, instead of \$3,200,000 asked by the secretaries of war and the navy.

The plan to organize an Aerial Reserve Corps proposed by the "New York World" and the Aero Club of America, was authorized on July 13 by President Wilson, after a committee of the club's Executive Committee called at the White House and recommended the authorization of the plan.

The plan of the Aerial Coast Patrol was promptly endorsed by President Wilson and the secretaries of war and navy, and an appropriation of \$1,500,000 has been promised for putting the plan into effect.

Steps were taken to establish aerial coast patrol units, and a complete unit was established at Port Washington, Long Island—the Volunteer Aerial Coast Patrol Unit No. 1, organized by F. Trubee Davison and eleven other patriotic young men. This unit rendered valuable service in connection with the "Mosquito Fleet" manœuvres.

A Bill was introduced in the Senate to appropriate the sum of \$1,500,000 for establishing units of the Aerial Coast Patrol under the auspices of the Navy, and in connection with the Naval Militia and Naval Reserves, but owing to the shortness of time, and the pressure of legislative business, Congress could not act upon it during the past session.

The plan to use aeroplanes in connection with the Coast Guard, for the Life-Saving Service and Revenue Cutter Service, first recommended by me five years ago, and since advocated by the Aero Club of America, and substantially supported by Byron R. Newton, the assistant secretary of the treasury, has been adopted by Congress.

The plan to use aeroplanes for mail-carrying, advocated by the Aero Club of America for several years, has been adopted and the postmaster-general has invited bids for mail-carrying over different routes where there is now spent \$330,000 for carrying mail by other methods. This sum would be spent for aeroplane mail-carrying if suitable bids could be obtained. The post-office authorities are anxious to put this plan in operation and are giving every encouragement.

The plan to interest the universities in aerial defense, which the Aero Club of America has been carrying out in so far as it concerns aerial defense, and which was frowned upon some time ago, has been followed by a request from President Wilson to the heads of the leading universities to consider ways and means to arrange for the training in military science of students in sixteen of the country's leading universities and colleges under the auspices of the War Department.

Our committee, with the coöperation of Robert Bacon, offered a bonus of \$50 for each Harvard undergraduate who learned to fly and passed the F. A. I. pilot tests. Twenty-one undergraduates took a course; twelve have already passed the tests. We have also offered three medals of merit to each of the



First use of aeroplane in war conditions. Lieut. (now Brig.-Gen.) B. D. Foulois and P. Parmelee at Eagle Pass, March, 1911, with the aeroplane loaned to the Army by Robert J. Collier, President of the Aero Club of America.

hundred largest universities, having a total of about 350,000 students, the medals to be awarded to the three students who, by March 15, 1917, write the best essays on (a) Military Aeronautics; (b) Mechanics of the Aeroplane and Possible Technical Development in Aeronautics; (c) Possible Application of Aircraft for Utilitarian Purposes.

To foster progress in the technical branch of aeronautics and begin the work of standardizing, the committee, at the request of Thomas A. Edison, organized the American Society of Aeronautic Engineers, which now includes in its membership all the prominent aeronautic engineers. The society is now being combined with the Society of Automobile Engineers, and Motor-Traactor Engineers, and a new organization being created which is to be called the American Society of Automotive Engineers.

Appreciating the basic value of Pan-Americanism from the standpoint of national defense, the committee started a movement to develop Pan-American aeronautics. Alberto Santos-Dumont was invited to come to the United States to coöperate in this movement. He came, and has been traveling through South and Central America, as the club's representative, and has already done some very constructive work. The organization of the Pan-American Aeronautic Federation was a direct result of the work of the Executive Committee. This federation is already a most powerful organization, and will be more so as time goes on. A large Pan American Aeronautic Exposition is now being organized to be held next February. Mr. Henry Woodhouse, who, with Mr. Henry A. Wise Wood, has been the father of the Pan-American movement, is raising the \$10,000 needed for the Pan-

American Aviation Trophy, and prizes to be competed for at Rio de Janeiro next summer.

Giving a national defense aspect to the sport of flying resulted in two score of sportsmen taking up aviation and acquiring their own aeroplanes for use of national defense in case of emergency.

The success of the aviation meet, held at Sheepshead Bay last spring, was a direct result of the work of the National Aeroplane Fund. Remarkable records were made at this meet, including non-stop flights from Newport News to New York with passengers.

Subsequently, and with the hearty coöperation of the "New York World," a flight was made from New York to Washington, in which I was a passenger, for the purpose of carrying to Washington a special edition of the "New York World," which advocated the training of 2000 aviators, which plan was endorsed by the governors of practically all the States. This plan to train 2000 aviators was favorably considered by Congress, and when a letter sent to one of the Congressmen with a copy of the "World" was read on the floor of the House of Representatives, the House applauded and the letter was ordered printed in the "Congressional Record."

Subsequently, and with the hearty coöperation of Rear-Admiral Robert E. Peary, Congressmen Kahn, Lieb, Hulbert, and Senators Johnson and Sheppard, and Government officials, an exhibition of four aeroplanes was held in Washington. It lasted about two weeks and assisted greatly in educating the members of both Houses and making them realize the necessity of increasing the appropriations for aerial defense.

It was also through the interest created by the National Aeroplane Fund that Mr. Ralph Pulitzer of-

ferred the Pulitzer trophy, instituting the National Aerial Derby, which is to take place annually, and for which there has been set aside \$20,000 to be given as prizes, this sum being part of the contributions made to the National Aeroplane Fund by Mr. Emerson McMillin, who requested that his contributions be spent at the discretion of the Board for whatever purposes the Board deemed best.

To interest the younger generation in aeronautics, prizes were offered from the National Aeroplane Fund for model aeroplane contests, in which more than twenty model aero clubs in different parts of the country participated. Knowing that the Wright Brothers themselves became interested in aeronautics through a toy helicopter, we realized that offering prizes to encourage the younger generation may result in finding geniuses who may eventually create, or develop or invent something which will be of great value to mankind. To interest the still younger generation, at the time when the National Educational Association of the United States held its convention in New York, steps were taken to interest in aeronautics the 60,000 school teachers who attended the convention. An aeroplane exhibition was arranged espe-

cially for the teachers, and they were given copies of "Flying," donated by the publishers, containing the history of the development of aeronautics from the earliest ages; and a diploma to be awarded to a pupil in each school who writes the best composition on aeronautics.

The foregoing is only a brief outline of what has been accomplished by the National Aeroplane Fund. It would take many pages to give the less prominent achievements.

The committee received substantial and hearty support from the following governors of the club: Rear-Admiral Robert E. Peary, Cortlandt F. Bishop, John Hays Hammond, Jr., Evert Jansen Wendell, Charles Jerome Edwards, Albert Bond Lambert, George M. Myers, Henry B. Joy, Rodman Wanamaker, and the late Samuel H. Valentine.

It is hard for me to find words that will adequately express the value of the work done by Mr. Henry Woodhouse in connection with the National Aeroplane Fund. He subscribed the first \$1000 to make it possible to begin the National Aeroplane Fund, and then made additional contributions during the campaign. He has given his entire time, practically six-

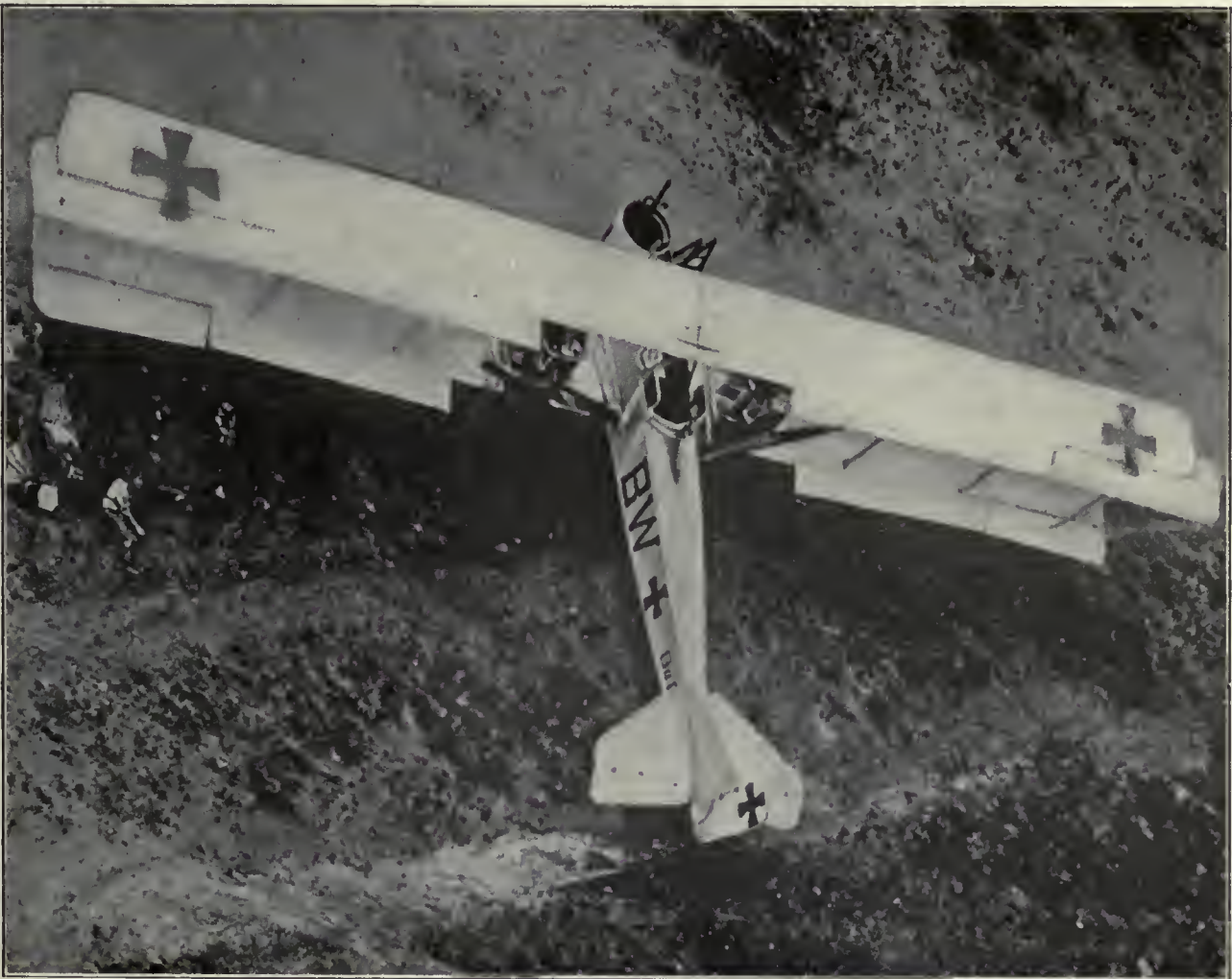

Looking down on a German Gotha resting on the ground. (British official photo.)

teen hours a day, every day, including Sundays and holidays, to this work, practically only leaving the club house on occasions when he had to deliver addresses and to attend meetings or make trips of inspection in connection with the furthering of this campaign. He has done this without compensation or expectation of compensation.

Very sincerely yours,
ALAN R. HAWLEY,
Chairman.

Firing Guns, Dropping Large Bombs, and Two-Engined Aeroplanes Once Considered Impossibilities

The writer clearly remembers that in 1910-13 the firing of machine-guns and the dropping of large bombs from aeroplanes were considered impossibilities. It was held that the recoil of a gun would upset the aeroplanes; while the dropping of weight of more than fifty pounds would upset the aeroplane. For that reason it was held that aeroplanes could only be used for scouting, directing artillery fire, and taking photographs. The development of speedy aeroplanes was discouraged. Those who expressed the possibility of equipping aeroplanes with two or more motors were considered visionary, the general opinion being that an aeroplane equipped with two motors would fail. Two

reasons were given: First, the machine would be unable to lift its own weight; secondly, if one motor stopped, the other motor would make the machine spin.

Speed in aeroplanes was developed, therefore, entirely by private efforts, mainly by sportsmen and aero-clubs in connection with the annual competition for the Gordon-Bennett Cup. As early as 1912 this trophy was won by a flight of over one hour at a speed of 105 miles per hour. In 1913 the winner of the Gordon-Bennett Cup made a speed of 124 miles an hour for about one hour.

In 1913 a prize of \$15,000 was offered by Mr. Edwin Gould, a member of the Aero Club of America, in a competition for twin-motored aeroplanes, but it was not won, although the conditions required only a flight of about one hour.

Following is given, for historic purposes, a table of the performances required by the British War Office for aeroplanes of different types on February 9, 1914.

British Army Tests for Aeroplanes in 1914

1. The Chief Inspector of Military Aeronautics is prepared, on the request of an aeroplane constructor, to put an aeroplane through



Orville Wright and Lieutenant Selfridge in the Wright Flyer, built for the U. S. Army, on the day of the tragedy which cost the life of Lieutenant Selfridge, who was the first man to be killed flying in an aeroplane.

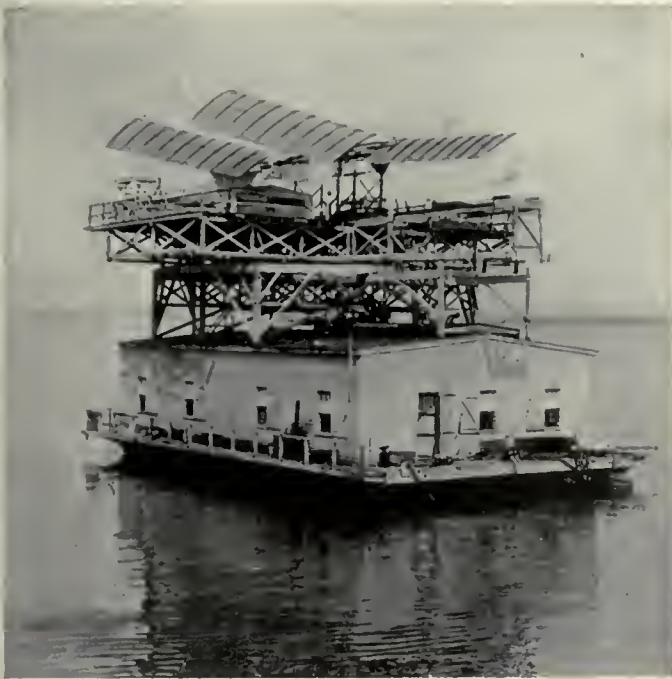

The Langley Aerodrome.

Then the United States Government commissioned C. P. Langley to construct a man-carrying aeroplane. The "aerodrome" was a remarkable advance step, but the experiments were not concluded.

the ordinary military acceptance test under the following conditions:

(a) The test consists of examination of workmanship and materials, speed test, fast and slow, climbing, weight of load carried, rolling test, and one hour's flight. The constructor must supply the pilot and passenger. For purposes of calculation weights of pilot and passenger will be 160 lbs. each.

(b) Stress diagrams in duplicate for the aeroplane must be sent with or before the machine. A minimum factor of safety of 6 throughout is essential.

(c) No machine will be tested for military purposes unless it fulfils the conditions of one of

the types used for military purposes. These are given in attached table.

(d) The constructor, when applying to have his machine tested, should state his reasonable expectation of the performances of the machine.

(e) Aeroplanes submitted for test must be put through the whole of the test unless damaged before their completion, or unless the Chief Inspector considers that the test should be stopped for reasons of safety.

2. The Chief Inspector of Military Aeronautics is also prepared to examine and test aeroplanes which may be designed not for purely military purposes, but to demonstrate some practical or theoretical improvement in design or construction. The tests imposed in such cases will be at the discretion of the Chief Inspector.

3. Results of any test will be supplied to the constructor by the Chief Inspector, and will be kept secret, if desired by the constructor. Should the constructor wish to publish the result of the test, it is to be understood that the result should be published complete. Should only part of any report of the test be published, the Chief Inspector reserves the right to publish it in full.

4. The satisfactory performance of the tests laid down in paragraph 1 does not constitute a guarantee that the aeroplane in question will be purchased by Government.

5. These tests may be altered from time to time; notice will be given as early as possible of any alteration.

War Office,
February, 1914.

PERFORMANCES REQUIRED FROM VARIOUS MILITARY TYPES

	Light Scout.	Reconnaissance Aeroplane (a).	Reconnaissance Aeroplane (b).	Fighting Aeroplane (a).	Fighting Aeropinne (b).
Tankage to give an endurance of	300 miles.	300 miles.	200 miles.	200 miles.	300 miles.
To carry	Pilot only.	Pilot and observer, plus 80 lbs. for wireless equipment.	Pilot and observer, plus 80 lbs. for wireless equipment.	Pilot and gunner, plus 300 lbs. for gun and ammunition.	Pilot and gunner, plus 100 lbs.
Range of speed	50 to 85 m.p.h.	45 to 75 m.p.h.	35 to 60 m.p.h.	45 to 65 m.p.h.	45 to 75 m.p.h.
To climb 3500 feet in	5 minutes.	7 minutes.	10 minutes.	10 minutes.	8 minutes.
Miscellaneous qualities	Capable of being started by the pilot single-handed.		To land over a 30-ft. vertical obstacle and pull up within a distance of 100 yds. from that obstacle, the wind not being more than 15 m.p.h. A very good view essential.	A clear field of fire in every direction up to 30° from the line of flight.	A clear field of fire in every direction up to 30° from the line of flight.

Instructional aeroplanes with an endurance of 150 miles will also be tested under special conditions; safety and ease of handling will be of first importance in this type.

The Clement Ader Avion.

In 1890-1897 the French Government planned to construct an aerial fleet and engaged Clement Ader to do it. It was the first time a government had actually ordered an aeroplane for military use. Ader's *Avion* was wrecked in the first attempt to fly.

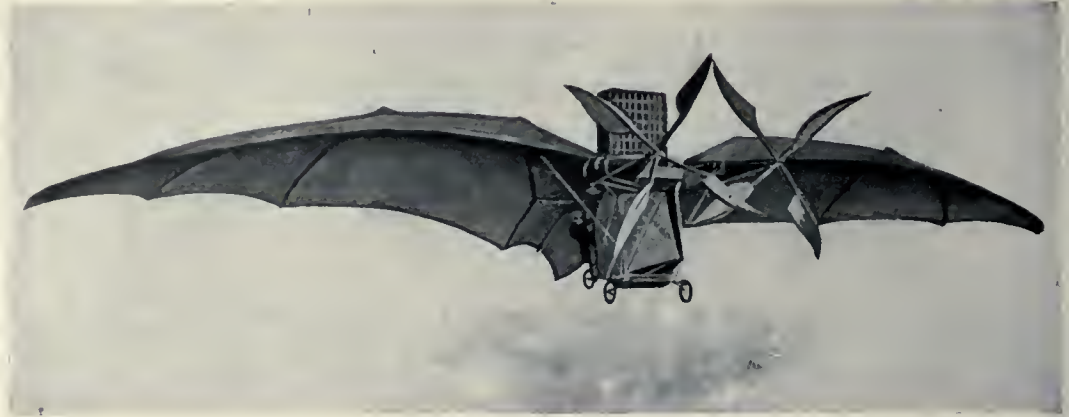

Aeronautics at the Outbreak of the War

GERMANY'S COSTLY FAILURE TO EMPLOY AIRCRAFT IN THE BELGIUM INVASION

Although all aeronautic activities in Europe before the Great War were of a military nature, plans for the employment of aircraft for military purposes were by no means extensive. True, the largest European nations had between 500 and 2000 aeroplanes each, and some of the powers, especially Germany, had fleets of dirigibles and some observation balloons. But military aeronautics was not a defined science. Though there was no doubt about the value of aircraft for scouting purposes, and an

expectation that Zeppelins could do awful damage with their bombs, the general application of aircraft for military purposes was mainly a matter of opinion. While some of the aeronautic experts were good prophets, their opinion was questioned by thousands of people who considered these experts visionaries. Military men of the old school were slow to accept the value of aircraft. As a matter of fact, the Germans themselves suffered their greatest loss through failure to recognize the value of aircraft and through failure to employ them in their initial campaign against Belgium.

There is evidence that Germany in her underestimation of the tenacity of Belgium did not make use of her air scouts during the first period of her campaign. She relied entirely on the



One of the early Russian Sykorsky warplanes, the first machines to carry multiple power plants.

overwhelming strength of her formidable army, and did not consider it necessary to employ air scouts to find vulnerable spots and offset the advantage gained by Belgium through the latter's judicious employment of the able Belgian air scouts. The Germans started in with a crushing preponderance of men, but played the game in accordance with plans made many years ago, with little consideration for the immediate moves of the enemy. Belgium, with few men, but employing a score of efficient air scouts, moved as circumstances dictated. The result was a comparatively large loss of men and inestimable loss of time on the part of the Germans. But for that loss, the Germans might have gone through Belgium and on to Paris before the French had time to complete their preparations.

For the better part of the first year of the war aerial operations were almost entirely confined to scouting, directing artillery fire, and an occasional raid. This was true of both the heavier and lighter-than-air craft.

Then a logical expansion took place. Each side tried to prevent the air scouts of the enemy from reconnoitering and carrying back information they had gathered; also to prevent enemy aircraft from dropping bombs over their lines. This started a period of aerial fighting, which has governed the supremacy of the air ever since.

The side which has the best air fighters holds the supremacy of the air on the fronts and, while able to get information about every movement of the enemy, has it in its power to prevent that enemy from obtaining like information. Air superiority may be said to be responsible for all the victories on the different fronts in the present war.

Next came the famous Boëlke and Immelman with their high horse-powered Fokker monoplane, merely a development of the French Morane-Saulnier monoplane, equipped with a 160 horse-power engine. Boëlke and Immelman would ascend 15,000 or 18,000 feet and watch for an opportunity to pounce down on an enemy aeroplane, shooting while diving downward. These two crack German aviators brought down a number of Allied aviators before the Allied commanders realized what was

happening. Then the Allies brought out their very fast machines.

These included the famous Nieuport biplanes and Sopwith speed biplanes, and these were quickly followed by the "Spads" and other fast machines. The Allies developed a great many crack aviators, including Lieutenants Navarre, Guynemer, William Thaw, Norman Prince, Captain Hall, and other famous aviators.

A new development came with the employment of large aeroplanes, capable of carrying hundreds of pounds of explosives. These were used by both sides to bombard enemy positions, and made it necessary for each side to be everlastingly on the watch to protect its cities and bases from aerial attack, thereby withdrawing many aviators from the fronts. But the number of aeroplanes employed was always too small to permit achieving decisive victories through reducing positions from the air.

The next development of importance, which took place in 1916, was the employment of aeroplanes to perform the functions of cavalry, in engaging the enemy and the anti-aircraft guns; also the functions of the artillery, in bombarding and destroying trains, bridges, and bases; and lastly the functions of the infantry, by flying low and attacking troops in the trenches or along roads.

Advent of Large Warplanes in 1917 Permitted Conducting Major Aerial Operations

The advent of large warplanes in 1917 permitted conducting major aerial operations. The Italians set the precedent by conducting numerous air raids on Austrian bases with their large Caproni warplanes. (See chapter on "Warplanes for Bombing and Launching Torpedoes.")

Russia probably could have done the same two years earlier by employing the large Sykorsky aeroplanes, but the Russian Government did not have the organization or a clear idea of the value of the large warplanes, and the value of the Sykorsky warplanes was lost in a succession of failures due to lack of organization. When the Sykorsky machines were ordered to fly to the front from their base hun-

dreds of miles away, no provision was made for landing-places along the route, and the field from which they were to operate near the front was not suitable for large machines. The result was that only two machines out of a dozen survived the journey from the home base.

As the Sykorsky machines were slow, they were best adapted for night work, but there was no organization for work of this nature. Therefore the machines were only used for day operations, and in this style of fighting they were no match for the smaller, but faster German machines. Being slow, they were easy targets for the anti-aircraft guns.

The Italians began with a very efficient organization and a thorough appreciation of the value of night operations. At first they had only a small number of machines, but as fast as they could build more they increased the number of their raiding squadrons. By August, 1917, they were able to send 232 aeroplanes in one raid, during which they lost only one aeroplane.

The United States Lagged Behind for Seven Years

After gaining the distinction of owning the first military aeroplane, the United States practically stood still, while other nations developed large air fleets. From the time the first aeroplane was purchased until 1916, the appropriation for army aeronautics aggregated only \$600,000. The small sums allowed each year were not sufficient to support even one manufacturer, and as orders were distributed among a number of manufacturers, and the requirements for aeroplanes changed with each order, the aeroplane manufacturers did business with the Government at a loss. During this period the aeronautic industry was kept alive mainly by civilian support and the hope of better times.

In 1915-16 the British Government placed substantial orders with American aeroplane manufacturers, totalling about \$13,000,000, and thereby developed the American aeronautic industry. But these orders were entirely for training machines and sea-planes, and as there was no demand for fast fighting-machines or large bombing-machines, these types did not get beyond the experimental stage.

Aero Club of America's Monumental Work in Developing Our Aerial Forces

Throughout these lean years the Aero Club of America was the main factor in developing our aerial forces. This patriotic organization, which has fostered the development of aeronautics in America since 1905, worked incessantly to build up the air service. Through energetic efforts it succeeded in having appropriations for military aeronautics increased, and trained, or caused to be trained, several hundred militia and civilian aviators who later became aviators in the Aviation Officers' Reserve Corps.

In 1914-15 the Aero Club of America pointed out that with 5000 aviators this country would be in the position of the porcupine, which goes about its daily pursuits, harms no one, but is ever ready to defend itself.

When the 63rd Congress appropriated only \$250,000 for aeronautics during 1915, the Aero Club of America authorized the institution of a National Aeroplane Fund to develop our aerial defenses. Some idea of the important accomplishments made possible by this fund can be gained from the following excerpts from the report presented to the Board of Governors of the club by Mr. Alan R. Hawley, chairman of the committee which had charge of this fund.

America's Entry into the War Brings Decision to Concentrate Efforts to Strike Germany Through the Air

Following America's entry into the war, the Council of National Defense created the Aircraft Production Board, to coöperate with the army and navy to increase the production of aircraft for the United States, as well as for the Allies.

While the Aircraft Production Board and the military authorities were considering plans to develop a substantial air service, the Aero Club of America issued a series of statements pointing out that an additional 10,000 aviators would make it possible to conduct aerial raids on a large scale and to strike Germany in vital places,—to strike hard enough to lead to permanent victories. It recommended the appropriation of one billion dollars to carry out this

plan of striking Germany through the air. Congressman Murray Hulbert of New York and Senator Morris Sheppard of Texas, who had introduced a Bill to create a separate department of aeronautics, held hearings in the Senate at which authorities testified to the importance of aeronautics.

The statements of the Aero Club of America and other authorities were published daily in the press for about one month, and the leading newspapers also sponsored the project to build large air fleets. As a result, practically every paper in the country gave editorial support to the recommendations for a large appropriation for aeronautics, and when the Bill to appropriate \$640,000,000, which had been approved by Secretary Baker, came up for vote in the House of Representatives on July 14, 1917, it passed the House without a dissenting vote. The Senate passed it a few days later.

In the meantime, the Aircraft Production Board and the Signal Corps had been developing plans for large aviation schools, so that they were ready to start training aviators when the appropriation became available.

The Problem of Delivering Aeroplanes to Europe

The one serious problem is the delivery of aeroplanes to Europe. To deliver 100,000 aeroplanes would probably take most of the tonnage at the disposal of the Allies, to the exclusion of practically everything else. At date of writing the Aero Club of America's plan to fly the machines across the Atlantic is being considered.

British Air Ministry Created

The frequent bombing raids on British soil, together with certain very evident disadvantages to which the Allies were put through Great Britain's failure to bomb German manufacturing centers, destroying German bases, railroads, and the bridges on the Rhine, caused continuous criticism of the British Government. This criticism became very severe in 1916, and an investigation of the British Flying Corps was instituted, which lasted from May to August. As a result of this investigation, certain changes were made in the management of the Royal Aircraft Factory, and then, in February, 1917, the Air Board was created.

The members of the Air Board were: The Right Hon. Viscount Cowdray, President; Major J. L. Baird, C. M. G., D. S. O., M. P., Parliamentary Secretary; Commodore Godfrey Paine,

C. B. M. V. O., R. N., Director of Air Service (D. S. A.); Lieutenant-General Sir David Anderson, K. C. B.; Major-General J. M. Salmon, C. M. G., D. S. O., Director General of Military Aeronautics (D. G. M. A.); Sir William Weir, Controller of Aeronautical Supplies (C. A. S.); Mr. Percy Marin, Controller of Petrol Engines (C. P. E.).

The Air Board had only limited power. It could only discuss matters of policy in relation to the air program in general, consider the programs of construction of aeroplanes and seaplanes formulated by the Admiralty and the War Office, and select and be responsible for the designs of aeroplanes and seaplanes and their engines and accessories.

The policy of not conducting major aerial operations against the Germans continued with the new Air Board. As the Germans succeeded in maintaining their own on the Western front, at the same time striking a heavy blow at Italy and Russia, the criticisms of the British Government due to dissatisfaction with the management of aerial matters grew more and more severe. Decision was then reached to establish an Air Ministry. This was done in November, 1917. The position of air minister was offered by Lloyd George to Lord Northcliffe, who declined it. It was then offered to Lord Rothermere, Lord Northcliffe's brother, who accepted it.

The Air Council of the British Air Ministry was established on January 2, 1918. It was constituted as follows:

Lord Rothermere, Secretary of State and President of the Council; Major-General Sir H. Trenchard, K. C. B., D. S. O., Chief of the Air Staff; Rear-Admiral Mark Kerr, C. B. R. N., Deputy Chief of the Air Staff; Commodore Godfrey Paine, C. B., M. V. O., R. N., Major-General of Personnel; Major-General W. S. Brancker, Controller-General of Equipment; Sir William Weir, Director General of Aircraft Production in the Ministry of Munitions; Sir John Hunter, Administrator of Works and Buildings; Major J. L. Baird, C. M. J., D. S. O., M. P., Parliamentary Under-Secretary of State; Lieutenant-General Sir David Henderson, K. C. B., D. S. O., Additional Member of Council and Vice-President.

Mr. W. A. Robinson, C. B., has been appointed to act temporarily as secretary to the Council, and Mr. H. W. McNally to act as assistant secretary.

Sir John Hunter, K. B. E., will continue to perform his present duties in the Ministry of Munitions, in addition to acting as Administrator of Works and Buildings in the Air Ministry.¹

The German drive in March-April, 1918, emphasized anew the importance of aircraft and the vital necessity of maintaining aerial supremacy. In the meantime the price of maintaining aerial supremacy had increased. Whereas in 1916 it took only about twenty per cent. replacements of aviators and fifty per cent. of machines per month to keep aero squadrons on the front, in 1918 it took over double that number. This was due to higher skill and more extensive aerial fighting; increase in day and night bombing at low altitudes; increased efficiency of anti-aircraft batteries, firing on troops from low-flying aeroplanes, etc. In other words, to aim to keep 5000 aviators on the fighting-lines for the year 1918-1919 involved supplying 29,000 aviators, requiring an average of two aeroplanes each to train, and from 60,000 to 70,000 machines.

The United States had not provided for such an expansion. Its July, 1917, plan was the smallest plan that could be adopted at the time when Italy was victorious and Russia was still fighting. The Senate hearings brought out the fact that it had not been changed in the early spring of 1918, when the German drive started.

¹ The text of Act Creating British Air Ministry is to be found in *Flying* (a monthly published at 280 Madison Avenue, New York City for January, 1918). The text of the first estimates of British Air Ministry and definition of duties and powers of officials of the Air Ministry, and the basis of coöperation between the Air Ministry and the Admiralty and War Office appear in *Flying* for May, 1918.

TABLE OF THE LEADING AMERICAN AEROPLANES. LAND MACHINES, 1916-1917

MAKER	Type	Wing Span		Chord	Gap	Total Length	Landing Gear	Motor	Speed Range in Mi. per Hr.	Net Weight
		Upper	Lower							
Aeromarine	Training Machine	37'-0"	33'-0"	6'-0"	6'-0"	25'-0"	2 wheels	Hall-Scott—100 h.p.	78-40	1900 lbs.
Atlantic	Twin-motored Tractor	48'-0"	48'-0"	5'-0"	5'-3"	28'-6"	U type—4 wheels	(2) Aeromarine—90 h.p.	85-50
Andermat	Twin-motored Tractor	(2) Hall-Scott—135 h.p.
Barnhart	Tractor	34'-0"	26'-0"	5'-0"	5'-0"	20'-6"	U type—2 wheels	Curtiss—100 h.p.	84-43	1200
Bates Aeroplane Co.	"H-17" Tractor	45'-0"	45'-0"	5'-0"	6'-0"	24'-0"	3 wheels	Roberts 6x-100 h.p.	64-45	1400
Boeing Airplane Co.
Breese-Montant Corp.
Burgess Company	Primary Training Tractor	41'-6"	34'-0"	6'-6"	6'-0"	23'-11"	3 wheels	Curtiss—90 h.p.
Champion Aero Co.	Pontkowski	37'-0"	28'-0"	5'-4"	5'-4"	22'-6"	V—2 wheels	Sturtevant—70 h.p.	65-	1000
Chicago Aero Works	Stupar Tractor	38'-0"	26'-0"	5'-0"	5'-0"	20'-6"	2 wheels	Maximotor or Curtiss—50 h.p.	65-40	750
Christofferson	Military Tractor	48'-0"	33'-0"	5'-6"	5'-9"	3 wheels	Christofferson	80-40
Curtiss Aeroplane Co.	"J-N 4-B" Tractor	43'-7"	34'-0"	5'-0"	5'-2"	27'-3"	V—2 wheels	Curtiss—90 h.p.	75-43	1405
Curtiss Aeroplane Co.	Twin-motored J.N. Tractor	52'-10"	43'-2"	5'-0"	5'-2"	29'-4"	V—2 wheels	(2) Curtiss—100 h.p.	85-48	2110
Curtiss Aeroplane Co.	Speed Scout	20'-0"	18'-0"	4'-6"	5'-0"	19'-0"	V—2 wheels	Curtiss—100 h.p.	100-50	1200
Curtiss Aeroplane Co.	R. 4 Tractor	48'-4"	38'-5"	6'-3"	6'-2"	28'-11"	V—2 wheels	Curtiss—200 hp.	90-48	2225
Curtiss Aeroplane Co.	Triplane Scout "S-3"	25'-0"	25'-0"	2'-0"	19'-6"	V—2 wheels	Curtiss—100 hp.	115-55	795
Dayton-Wright Co.
Fisher Body Co.
Flint Aircraft Mfg. Co.
Gallaudet Aircraft Corp.	"Alpha" Tractor	48'-0"	48'-0"	7'-0"	7'-7"	35'-0"	2 wheels	(2) Duesenberg—150 h.p.
General Aeroplane Co.	36'-6"	36'-6"	5'-8"	5'-0"	26'-0"	2 skids & wheels	Curtiss—100 h.p.	86-37	1100
Grinnell	37'-6"	37'-6"	6'-0"	V—2 wheels	Robinson—100 h.p.	75-	1100
Heinrich Corporation
Janney Aircraft Co.
Laird Aviation Co.	Tractor	26'-0"	26'-0"	4'-6"	5'-0"	22'-0"	V—2 wheels	Anzani—45 h.p.	63-36	750
Lanzius Aircraft Co.	Changeable Incidence	Duesenberg—150 h.p.
L. W. F. Engineering Co.	Military Tractor	42'-0"	34'-9"	6'-0"	6'-6"	28'-0"	V—2 wheels	Thomas—135 h.p.	93-45
M. F. P. Aero Co.	Steel Tractor	45'-0"	36'-0"	5'-3"	5'-6"	26'-6"	U—2 wheels	Hall-Scott—135 h.p.	1300
New Jersey Aero Co.	Tractor	V—2 wheels	J. A. C.—80 h.p.
Shinncock	20'-0"	17'-0"	V—2 wheels
Standard Aero Corporation	Model "H-3" Tractor	40'-1"	40'-1"	6'-6"	6'-6"	27'-0"	V—2 wheels	Hall-Scott—135 h.p.	84-46	1700
Standard Aero Corporation	Model J	43'-11"	32'-0"	6'-0"	6'-0"	26'-7"	V—3 wheels	Hall-Scott—90 h.p.	68-37	1350
Standard Aero Corporation	Model JR	42'-10"	31'-0"	6'-0"	5'-11"	27'-2"	V—2 wheels	Hull-Scott—175 h.p.	95-48	1764
Sturtevant Aeroplane Co.	Steel Battleplane	38'-0"	38'-0"	6'-0"	6'-0"	25'-0"	V—2 wheels	Sturtevant—140 h.p.	75-35
Thomas-Morse Aircraft Corp.	"D-2" Tractor	37'-0"	37'-0"	5'-3"	5'-0"	25'-6"	2 wheels & skids	Thomas—135 h.p.	90-42	1450
Thomas-Morse Aircraft Corp.	Twin-motored Battleplane	78'-6"	62'-0"	7'-0"	6'-6"	37'-6"	V type—4 wheels	(2) Thomas—140 h.p.	89-46	3250
Thomas-Morse Aircraft Corp.	D-5 Reconnaissance	52'-9"	34'-0"	5'-6"	5'-3"	29'-9"	2 wheels	Thomas—140 h.p.	86-48	2000
Timm Aviation Co.	Exhibition Tractor	33'-0"	26'-0"	5'-0"	5'-0"	20'-0"	V—2 wheels	Robinson—100 h.p.	850
United Eastern Aero Corp.	Preliminary Training Tractor	41'-0"	32'-7"	5'-3"	5'-6"	27'-0"	Skids & 2 wheels	Hall-Scott—90 h.p.	75-40	1550
Wittebmann-Lewis Co.	Military Training Tractor	42'-0"	34'-0"	5'-6"	5'-6"	27'-2"	U—2 wheels	Hall-Scott—90 h.p.	70-35	1530
Williams Aeroplane Co.
Wright-Martin Co.	Military Tractor	50'-7"	36'-9"	5'-6"	26'-7"	2 wheels	Hall-Scott—150 h.p.	86-47	1740
Wright-Martin Co.	Wright Type H. S. Pusher	32'-0"	32'-0"	6'-0"	5'-6"	25'-3"	V type—2 wheels	Wright—60 h.p.	76-42	1300
Wright-Martin Co.	Wright Type "L" Tractor	29'-0"	29'-0"	5'-8"	6'-6"	24'-0"	V—2 wheels	Wright—60 h.p.	80-40	850
Wright-Martin Co.	Model "V"	39'-8"	39'-8"	5'-9"	5'-7"	27'-2"	V—2 wheels	Hispano—150 h.p.	1725

CHAPTER XIX

SOME PROBLEMS IN AEROPLANE CONSTRUCTION

By Capt. V. E. Clark, Chief Aeronautic Engineer, United States Army; Capt. T. F. Dodd, Signal Corps, United States Army; and D. E. Strahlmann, Engineer, War Department, Office of the Chief Signal Officer. (Paper presented January 1917 to the Society of Automotive Engineers.)

In this paper we shall advance for discussion, with hopes of solution, some important problems connected with the construction of aeroplanes intended for military uses in the United States. Many of these problems also apply to aeroplanes built for commercial and sporting purposes. Although the lessons on type development that are being learned in the European war are of immense value to us, many conditions that we must meet are peculiar to this country.

Military Functions of Aeroplanes

We will first consider the various military functions (becoming more and more distinct), as we understand them at present. It must be borne in mind that other important uses will, in all likelihood, develop. The aeroplane itself and its uses in war are so new that it is impossible to predict, with any degree of accuracy, the developments in even a few months. At present the aeroplane is being used in war for reconnaissance, fire control, rapid transportation of important officers or communication, demolition of valuable structures by bombing, and to attack hostile aeroplanes in order to prevent them from performing these functions.

1a—STRATEGICAL-RECONNAISSANCE MACHINES

For this work the fuel capacity should insure a flight of at least 500 miles without stop. The average speed during this flight should not be less than 80 m.p.h. The *military load* consists of one pilot, one observer, a sketching outfit, a camera, a wireless set, and navigating instruments.

The general rule is becoming more and more firmly established that no military aeroplane

should be entirely defenseless against the attack of hostile aeroplanes.

This and all other service types should carry one or more machine guns, and the general arrangement of the system should be such as to permit extensive fields of fire in important directions.

The useful load, that is, fuel plus the *military load*, and the speed range, determine the power required. A powerplant of about 200 h.p. would apparently satisfy most economically this problem, the primary requirements of the powerplant being reliability and fuel efficiency.

Assuming this, the fuel will weigh between 700 and 800 lbs. The military load will be almost 600 lbs. The complete aeroplane, fully loaded, will weigh over 3,500 lbs.

This aeroplane would also be adapted for long-distance transportation of important communications or officers.

1b—TACTICAL-RECONNAISSANCE MACHINES

The fuel capacity of this type should insure a continuous flight of at least 250 miles at a speed of not less than 85 m.p.h. The military load should be about the same as that carried in the strategical-reconnaissance machine.

A powerplant of about 125 h.p. is desired, the primary requirement being reliability. The fuel will weigh about 225 lbs., the aeroplane loaded somewhat less than 2,400 lbs.

2—FIELD-ARTILLERY FIRE-CONTROL

The tactical-reconnaissance machine can perhaps perform this duty, but it appears that the fire-control machine should be slower, and that one of its primary requirements should be an

extremely good field of vision. The engine should be of 125 h.p., or perhaps less.

3—LONG-RANGER BOMBERS

We here attack a more difficult problem, owing to the heavy useful load with which we must climb from the starting field.

There will probably be a wide range in sizes of machines intended for this duty. We will discuss what we might call an average type at the present time.

The fuel capacity should permit going out at least 200 miles and returning safely, starting with a load of bombs weighing, say, 400 lbs. The machine should be capable of defending itself from hostile aircraft, so that it can operate independently of escort.

It appears that we need at least 250 h.p. and that, depending upon the total useful load, 300 h.p., or even 350, would not be too great.

If we assume 300 h.p., the fuel weight will be at least 900 lbs. and the total military load, including bombs, about the same.

This aeroplane will weigh, loaded, between 5,000 and 6,000 lbs.

4—PURSUIT MACHINES

The function of this type is to attack and drive off hostile aeroplanes of any of the three first-mentioned types, preventing them from accomplishing their purpose. In fact, the employment of this type should afford a sort of offensive defense against hostile aircraft of all descriptions.

While the types 1a, 1b, 2 and 3 are interested primarily in objects *on the ground*, the pursuit type is occupied solely with events *in the air*. This type is at present divided into the one and two-place subclasses.

a.—The *one-place machine* carries fuel for two hours at full speed, about 130 m.p.h. The pilot is the only occupant. He controls the machine and operates the machine gun, or guns, of which there can be from one to four. He usually aims the gun, in action, by "pointing" his aeroplane.

All characteristics are sacrificed to reasonable limits in order to obtain rapid climbing ability, high speed, rapid climbing ability at

high speed, and the greatest possible dodging ability, or "handiness."

In the engine, reliability must be sacrificed to a great extent to obtain low weight per horsepower, in order that the necessary attributes of the aeroplane can be obtained. Between 90 and 130 h.p. is desired. At present by far the greatest percentage of engines in this type of machine are of the rotary air-cooled type.

b.—The *two-place machine* carries fuel for three hours at full speed, about 110 m.p.h. Space is provided for two men, the pilot and the gun operator. This is, of course, somewhat larger and less agile than the one-place machine and, it is believed, is rapidly losing its popularity in favor of the smaller type. The power required is from 110 to 160 h.p.

5—OVERSEAS RECONNAISSANCE

a.—The long-range machine of this type must carry fuel for six hours at not less than 75 m.p.h. Two men, wireless-transmitting set and navigating instruments are carried. The 300-h.p. plant used on the bomber should answer for this type satisfactorily, the greatest requirements being reliability and fuel efficiency.

b.—The machine used for short-range reconnaissance and coast-artillery fire-control must carry fuel for three to four hours at speed of not less than 75 m.p.h. Two men, navigating instruments, wireless and other signaling apparatus will be required. The 200-h.p. engine used in the land strategic-reconnaissance machine should answer.

Some Problems in Construction

It is important that engineers work out the mechanical details of a great many problems in construction, among which are the two-propeller system, the reduction of vibration, the development of light engine starters, gasoline supply systems, devices required for safe landing and improvements in wing and propeller design.

THE TWO-PROPELLER SYSTEM

When an all-around field of fire is necessary, the best arrangement is to carry the two or three

operators and the main supply of gasoline in a central body, and to drive the machine by two propellers—one at each side of this central body.

By such an arrangement machine guns can be fired forward, in attack, and to the rear, in retreat, with extensive fields of fire in both directions, above and below, to right and to left. This attribute is always desirable, and, in some types, as for instance in the bombers and reconnaissance machines, is essential.

These propellers can be either tractor screws or "pushers." The left-hand propeller should turn clockwise and the right-hand propeller counter-clockwise. This symmetrical arrangement is a great advantage, in that it permits equalized torque and gyroscopic efforts when turning in different directions. In addition, it makes for safety, because the downward velocity imparted to the inboard parts of the two slip-streams that strike the horizontal tail-surfaces produces an inherent tendency toward nose heaviness without power and toward tail heaviness with power. We can, therefore, design so that the line of thrust is considerably above the center of gravity, compensating for this, and obtaining another convenient feature.

A fourth great advantage of such a system is the fact that great power can be transmitted with good propeller efficiency without demanding excessive diameter and retaining satisfactory structural safety factors. It is highly desirable that the line of thrust of the propeller be kept below the center of gravity of the aeroplane, unless the two-propeller arrangement, as described above, be used; a propeller of large diameter, with sufficient clearance, necessitates a high landing gear with its many great disadvantages. It appears extremely difficult to build a propeller of wood, of satisfactory strength (if the speed of revolution be high), giving good efficiency, to transmit more than 160 h.p. Peculiarly stringent climatic conditions making for rapid deterioration have increased this difficulty. In fact the tendency to reduce cylinder diameter and increase crankshaft revolution speed is already necessitating a gear between crankshaft and propeller-shaft in order to keep the propeller speed below 1,300 r.p.m., which is considered desirable.

A fifth advantage of the two-propeller arrangement is that the total resistance of the air to progress through it of the complete aeroplane while flying under power will be diminished owing to the fact that less total projected area of bodies will lie in the propeller slip-streams. The velocity of the air striking objects lying in the slip stream is, say, 20 per cent. higher than the velocity of air not in the slip stream. The resistance varies about as the square of the velocity. Therefore, all other things being equal, less power will be required to overcome the total resistance.

ARRANGEMENTS WITH TWO PROPELLERS

Four different systems for two-propeller installation have been suggested:

1. Two engines, one on each side, mounted out on the wings. The fundamental weakness of this system is that these great masses, removed so far from the center of gravity of the aeroplane, produce great moments of inertia, and consequently slow periods of oscillation. The machine is "logy" and probably not satisfactory for any but "hydro" purposes, in which case a "snappy" machine is impossible at best.

2. Two engines mounted in the central body between pilot and observer, each driving its own propeller through bevel gears and shafts, or by other method, the two systems being independent.

3. One large engine, mounted in the central body, driving both propellers, one propeller at each side.

4. Two engines, mounted in the central body, with a system of clutches connected with the transmission system in such a manner that either engine, or both engines, can drive both propellers, it being possible for the pilot to shift during flight.

The last system presents many advantages over the others, but it is entirely possible that excessive weight and complexity will render it impracticable. The system, as a whole, *must be reliable*.

In the design of any system of transmission for the two-propeller arrangement, the engineer must bear in mind that the structure of the wings supporting the propeller and trans-

mission is very light and rather flexible, usually vibrating during flight.

The information at hand indicates that, to date, no successful aeroplane of the two-propeller type has been developed, but it is urged that the possible advantages are such as to warrant great effort on the part of engineers toward this improvement.

METHODS OF REDUCING VIBRATION

The problem of reducing vibration of the aeroplane in flight, initiated by the engine, is a serious one. It is difficult to realize, without actual experience, the viciousness of this vibration, especially when the engine is of the eight-cylinder type, even though it is running normally. After one experiences this vibration, it is easy to understand why ignition systems, gasoline-supply joints, water-cooling systems, delicate instruments, and even wire terminals and structural joints of the aeroplane itself, deteriorate so rapidly.

The vibration throughout the aeroplane can of course be reduced by better design of the engine mounting, but we cannot hope to eliminate it entirely in this manner, if the engine itself is not of the proper design. We must not, in this connection, get the idea that the engine is always operating at the same speed during flight. We can, for instance, if flying at extremely high speed, turn the crankshaft over at, say 2,000 r.p.m.; whereas, if our sole object is to remain in the air without losing altitude, as when spotting for artillery fire, we can use a crankshaft speed of, say, not more than 1,200 r.p.m. The vibration at any speed should not be excessive.

STARTING MOTOR FOR ENGINES

The development of light starters is a matter of immediate importance. For instance, a seaplane equipped with two engines, one out on each wing, would be utterly useless without reliable starters. It seems quite probable that electric starters will be preferable, if the weight can be reduced sufficiently, and if the danger of spilling electrolyte be eliminated. It appears that any engine of over 140 h.p. requires a starter.

Reliable provision for starting the engine in extremely cold weather is necessary.

GASOLINE SUPPLY-SYSTEM

To date none of our pilots is anxious to fly across country with any except gravity feed.

The gasoline supply-systems Figs. 1 and 2, required by the U. S. Army for twin-engine seaplanes, is as follows:

The flow of fuel shall be from the main supply tank in central body to the gravity service-tank located at the center of the upper wing; from gravity service-tank by gravity, along the lower wing panels, to the small headers at the carbureters of the two engines, and from the small headers in each case to the carbureter.

These tanks shall have fuel capacities sufficient for operation at full rated power, as follows: Main supply tank, 4 hr. 35 min.; gravity service-tank, 25 min.; each header to carbureter, 1 min.

The design and material of the gasoline supply-system throughout shall be such as to obtain extreme lightness as far as consistent with strength and resistance to corrosion.

MAIN GASOLINE-SUPPLY TANK IN CENTRAL BODY

This shall be divided by one vertical longitudinal bulkhead and one vertical transverse bulk-

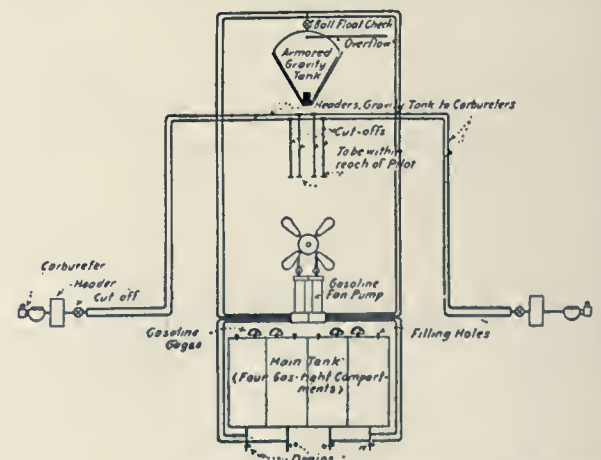

Fig. 1—Gasoline supply system (suction pump) for military seaplane

head into four gasoline-tight compartments. Proper swash-baffle plates shall be installed. The tank shall be of sturdy construction throughout.

The main tank shall be of such shape as to

properly fit the central body. It shall be securely fastened in the structure of the central body in such a way as to be undisturbed by any possible motion of the aeroplane. The structure shall be such that the tank will withstand an internal pressure of at least 7 lbs. per sq. in. without leakage of gasoline. The design shall be such that there will be no ill effects from drumhead vibration.

Suitable means shall be provided for quickly and conveniently filling and for completely draining all four compartments.

Each filling hole shall have a suitable screen filter, 100 mesh to the inch.

Plugs or caps for filling holes shall be airtight and provision shall be made for "safetying" them positively in place. Suitable gaskets shall be used.

Provision for reducing to a minimum the rate of leakage due to bullet holes by lining the inside of the tank with a special material, is highly desirable.

Suitable gasoline-supply gage shall be installed.

There shall be leads from the bottoms of the four compartments to the upper gravity service-tank.

SUPPLY OF GASOLINE FROM MAIN TO GRAVITY-SERVICE TANK

This shall be by two methods:

First.—Air fan driven pump, so designed as to maintain proper air pressure in or suction from the main tank system, and to operate satisfactorily during flight. An alternative and better method will be to install two such fans, each fan maintaining pressure in any two of the four compartments of the main tank. When any one or two of the four compartments of the main tank leaks (because of bullet hole or through other cause), an arrangement by which pressure or suction can be maintained through the leads from the tight compartments is highly desirable.

Second.—A hand air-pressure pump in or at the side of the pilot's cockpit, which can be used when not in flight or in an emergency. This pump shall be located in the cockpit at a point as high as will permit convenient operation by

the pilot in his seat. It shall be provided with a suitable air-pressure gage, visible to the pilot. Its connections with the compartments of the main tank shall be at a point as high as practicable to prevent the pump becoming flooded

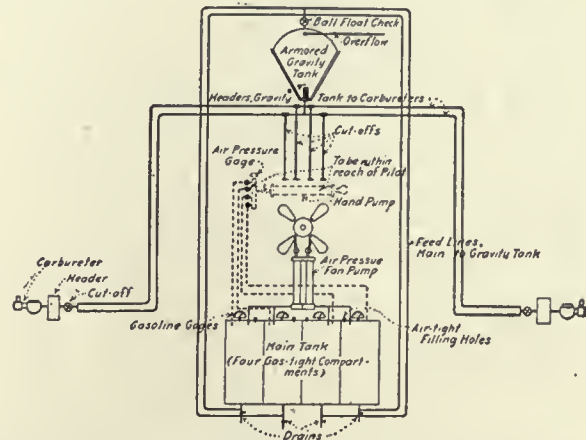

Fig. 2—Gasoline supply system (air pressure) for military seaplane

with gasoline. An arrangement by which pressure can be maintained by the hand air-pressure pump on tight compartments of the main tank when one or two compartments leak is highly desirable.

CONSTRUCTION OF GRAVITY SERVICE-TANK

This tank shall be of sturdy construction, securely supported in place, and provided with the proper number of swash-baffle plates. It is considered desirable to protect this tank with light V-shaped armor on the under side.

An automatic ball-float valve shall be provided to prevent overfilling of this tank. A suitable overflow pipe out of the top center of the gravity service-tank shall be provided. The gravity service-tank shall be of good stream-line form.

A suitable gage, visible to the pilot in his seat, shall be in the gravity service-tank. This gage shall be connected at such a point that it will register accurately through the range of normal flight attitudes.

From the gravity service-tank the gasoline shall be led to a small header at each engine by leads within or along the lower wing panels. Between gravity service-tank and each header shall be two independent, and, as far as practicable, isolated tube leads. Each of these four

leads shall connect with the lower part of the gravity service-tank at such a point that the supply will not be interrupted at any normal flight attitude.

At the connection of lead to the gravity service-tank shall be a suitable wire gauze strainer, mesh 100 to the inch. Provision shall be made to prevent the possibility of air pockets in the gasoline leads from the gravity service-tank. Provision shall be made for permitting the pilot, while in his seat, to cut off the gasoline supply, through all leads, from the gravity service-tank to the carbureter headers.

HEADERS BETWEEN CARBURETER AND SERVICE-TANK

A small cylindrical or stream-line tank or header shall be installed in the immediate vicinity of each carbureter. The gasoline shall pass through this header after coming from the gravity service-tank.

Its capacity shall be sufficient for one minute's running at full-rated horsepower. The central portion of this header shall be on a level with the jets of the carbureter. The axis of the cylinder shall be vertical.

The cylinder shall be of sufficient length to give satisfactory head, either when the aeroplane is in normal attitudes or when it is upside down.

Provision shall be made to prevent gasoline from backing up into the service lead instead of coming into the carbureter when the engine is upside down.

Suitable gasoline cutoff shall be installed near this header in such a position as to be convenient for operation to a man standing on the ground or on the wing.

TUBING FOR FUEL LEADS

At every point these shall be of the highest grade material best suited for the purpose. It shall be approved by the inspection department. Flexible tubing shall be $\frac{5}{16}$ -in. No. 2 copper tubing. Non-flexible leads shall be piping as approved by the inspection department.

Tubing shall in all cases be of diameter sufficient to give free and continuous flow under se-

vere vibratory conditions. In the absence of other instructions the bore shall be $\frac{5}{16}$ -in.

All tubing shall be securely fastened in such a way as to resist wear, vibration, and chafing. The number of joints and fittings shall be reduced to a minimum.

Unions, ells, tees, and fittings, to be S. A. E. standard, approved by the inspection department. The method of connecting all leads shall be approved by the inspection department. All fittings shall be readily accessible for inspection, adjustment, repair, or removal.

It will be seen that it will require considerable ingenuity to work out satisfactorily the mechanical details of this complicated arrangement. For instance, a satisfactory method of insuring feed from the compartments of the main tank, up to the gravity tank, when one or more of the main compartments are punctured by shot, is required.

METAL CONSTRUCTION FOR AEROPLANES

It is suggested that the field for development of steel aluminum alloy in the structure of aeroplanes is one offering considerable inducement. The authors have gone briefly through the layout of an aeroplane in which every strength member is of metal. In this design it was found most convenient to use seamless steel tube at some places, welded tube at others, channel section at others, I-section and L-section, at others. At a few points aluminum alloy was used, at other points pure aluminum, assumption being made that this aluminum was *rolled* in such a way as to give it certain desired physical characteristics.

It is suggested that, even with the present standard method of construction, there is great room for improvement in the material and method of heat treatment of the metal fittings used in conjunction with wood and wire. Especially where fittings are bent both with and across the grain, a special alloy appears advisable. The same holds for fittings shaped by die-forging. Chrome vanadium steel, to comply with S. A. E. specifications 6130, and heat treated in such a way as to render it best in each case, is suggested. It is believed that the total weight of an aeroplane can be materially de-

creased, without sacrifice of strength, and hence superior performance obtained, by the use of better steel.

The construction of floats of metal for seaplanes appears to be a possibility as is also the use of metal for aeroplane propellers. It is possible that the entire body might be made of light pressed steel, or aluminum, with holes to decrease the weight cut at proper places, and covered with linen.

FLEXIBLE PIPING

Satisfactory flexible gasoline lead has not yet been developed. Such a lead should resist the action of vibration, should be light in weight and resist cutting or denting. The method of making joints is important. The duct should be carefully sweated into proper terminal fittings. Tube ends of fittings should have spiral springs wound around them for at least $2\frac{1}{2}$ in., thus preventing sharp bends and disturbing the effects of vibration. All unions should be ground, with spherical seats, and threads should be cut clear and sharp, with all burrs removed. The inside diameter of tube should not be less than 0.35 in.

A *flexible* pipe, light in weight, of material suitable for leading the *exhaust* away from the engine would be useful.

MUFFLER REQUIREMENTS

In military service a hostile aeroplane is usually first discovered by hearing it. A muffler satisfactory as to low weight, flexibility, loss of power through back pressure, durability against corrosion, and efficiency as a muffler, is highly desirable.

SHOCK ABSORBERS FOR LANDING GEAR

Rubber is not satisfactory as a shock absorber for heavy aeroplanes. Neither is it satisfactory as a military supply, especially when it is subjected to heat and the direct rays of the sun. It seems necessary to develop a steel-spring shock-absorber. The action of this steel spring must, however, be damped by an oil cylinder. Without this damping the action is such as to cause the aeroplane to bound excessively upon striking the ground.

BRAKES REQUIRED WHEN LANDING

The development of a brake to reduce the run of the aeroplane after it has touched the ground, thus permitting it to land in restricted areas, appears to be a difficult problem. It is a moot question whether such a brake is desirable when the simple two-wheel landing gear is used, as its action has a tendency to throw the aeroplane over on its nose. Where more than two wheels are used, however, a brake fitted to the two main rear outside wheels in such a way that the pilot can, from his seat, operate either brake, or both brakes together, would be desirable. Such an arrangement would permit him not only to stop his machine quickly, but also to steer it on the ground to some extent.

FOLDING LANDING GEAR

The development of a landing gear that can be submerged within the body by the pilot, during flight, would materially increase the speed of the aeroplane by reducing the "parasite" resistance. Such a mechanism should be light in weight, sturdy and simple.

GASOLINE SUPPLY GAGE

The development of a gage to indicate the supply of gasoline remaining in the tanks to the pilot, whose seat can be out of view of the tanks, is necessary. Such a gage should be simple and sturdy. The accuracy and reliability with which it registers should not be affected by any change in altitude of the aeroplane. It should not form a possible source of leakage. It should be adapted to both the pressure and suction systems of feed.

FIRE SAFETY-DEVICE

Many casualties have occurred because the aeroplanes have caught fire in the air. While it has been impossible to determine from the wreck just what led to the fire, it is quite probable that many of these accidents were due to back fire into the carbureter that forced burning gasoline out into the surrounding structure, or to a leaking gasoline tank. The development of a device that will render such an accident impossible would save many lives.

In this connection it should always be a rule for aeroplane constructors never to have any electric lead near a gasoline supply or lead.

ALTITUDE ADJUSTMENT FOR A CARBURETER

The development of a device to regulate automatically the mixture for variations in density of air incident to changes in altitude, would be valuable.

VIBRATION-ABSORBING MATERIAL

The development of a material more suitable than ordinary felt for padding the points of support of radiators, and the like, is highly desirable.

VARIABLE RADIATORS

A more suitable method of permitting the pilot to adjust the amount of cooling done by the radiator in order to compensate for changes in temperature of air, or changes in speed through the air, is necessary. Such arrangement should permit operation by the pilot from his seat during flight, or, better yet, might be automatic; the device being operated as a function of the temperature of the water. It should be durable and should act with reliability.

VARIABLE-CAMBER WING

Great speed range is a desirable attribute of an aeroplane, as it permits high speed of travel in the air and yet low speed while landing, which of course makes for safety if the landing place be small or rough. Great improvement in the speed range can be brought about by use of a variable-camber wing surface, that is to say, if the section form of the aerofoil could be changed at will during flight from a shape such as *A* to one similar to *B*, Fig. 3.

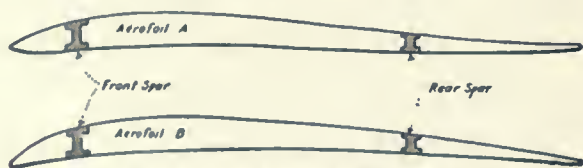

Fig. 3—Variable forms of aerofoil sections

An aerofoil such as shown in *B*, has a high lift coefficient at large angles of attack (the angle of attack being the angle between the chord tangent to the lower surface and the rela-

tive wind). At small angles of attack, where the lift coefficient is low, this shape has a relatively high resistance and will consequently require a great power to drive it through the air at speed high enough for the necessary support.

The reverse is true of such a shape as *A*, which, though the lift coefficient is poor, has an appreciably lower resistance or "drag."

If, then, we could utilize the section *B* for slow speed, as in making landings, and section *A* for high speed, the safe limits of speed between which the aeroplane could fly would be extended. The variable-camber would permit changing the characteristics of the wing to suit conditions.

Performance curves (Figs. 4 and 5) have

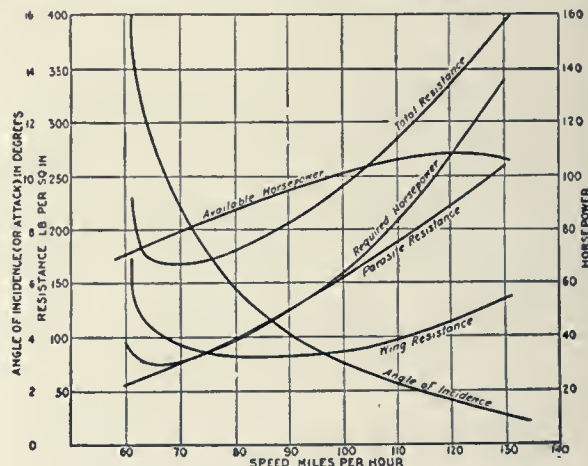

Fig. 4—Performance curves for aeroplane with fixed-camber wing

been worked out for a pursuit machine having a good aerofoil (fixed-camber) in common use today; and a similar series of curves for a machine with an assumed variable-camber wing. It has been assumed that otherwise both aeroplanes are similar. No allowance has been made for the probable increase in weight of the variable-camber machine due to the operating mechanism and structure.

The slow speed of the fixed-cambered wing aeroplane is 61 m.p.h. This will only permit landing the aeroplane on an ideal field by a very skilful pilot.

On the other hand the variable-cambered wing aeroplane can be flown at a slow speed of 56 m.p.h.

The curves show that with the variable camber a higher speed, 127 m.p.h., as against 120 for the fixed camber, can be obtained with the

same power. The same speed might be obtained with less power.

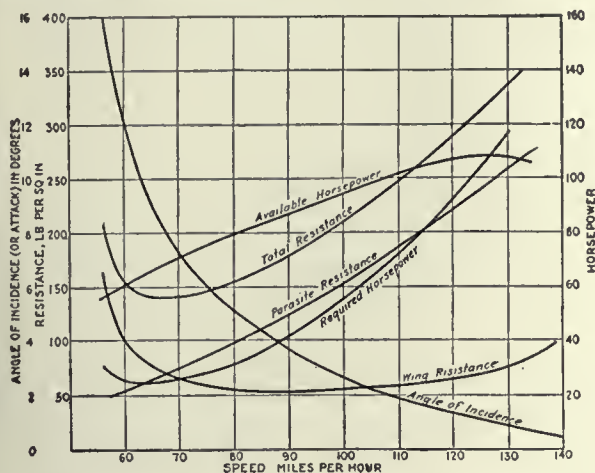

Fig. 5—Performance curves for aeroplane with variable-camber wing

If the same high speed were desired the variable-camber wing might have a greater area. It would then have a *slow speed* of 46 *m.p.h.* as against 61 for the fixed camber (allowing for increased weight due to added surface), which would permit its being flown and being landed in an ordinary field, by the ordinarily skilful pilot.

It can, therefore, be seen that the invention of a suitable variable-cambered wing would be a big step in advance.

APPENDIX

In calculating the values used in plotting the performance curves, Figs. 4 and 5, the weight of machine was assumed as 1150 lbs., and the engine was assumed to develop 140 b.h.p.

The lifting power of a wing is given by $L = K_v AV^2$, where L is the lift, K_v the lift coefficient (which varies for different altitudes of the wing to the relative wind and must be determined by experiment), A is the area of the wings and V the air speed.

Similarly the resistance of a wing is expressed by $D = K_x AV^2$, K_x being a variable coefficient that must be found by experiment.

The speed at which the aeroplane must fly for any assumed angle of attack can be found from the lift formula. The lift in all cases, of course, is assumed to be the weight of the aeroplane.

The resistance of the wings at these speeds can then be determined and the total resistance

found by adding the parasite resistance, that is, the resistance of the body, landing gear, etc.

From the total resistance the horsepower required can be calculated and plotted against speed. The horsepower available is obtained by multiplying the efficiency of the propeller by the brake horsepower delivered by the engine.

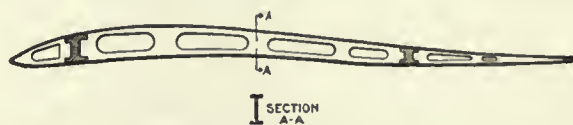

Fig. 6—Rib used in present type of wing construction

The ribs as ordinarily used in the present type of wing construction are as shown in Fig. 6. The weight of such a rib for a small pursuit machine, as assumed in the above calculations would be less than $\frac{1}{2}$ lb. The ribs would be spaced from 12 to 15 in. along the spars. A wing complete with cover, internal bracing, etc., weighs from 0.6 to 0.7 lb.

PROPELLERS WITH VARIABLE-PITCH ANGLE

Improved performance of an aeroplane, especially as regards radius of action, can be brought about by means of a propeller whose pitch angle can be varied by the pilot while in flight. The liability of failure, the complexity of the mechanism and the weight added, must be weighed against the gain obtained in the performance.

The gain in efficiency of the variable-pitch propeller over the fixed-blade type is considerable. This increased efficiency makes available more horsepower for climbing, giving faster climbing, and permits throttling down to attain the economical speed, and hence increases the flight radius and the time in the air with a given quantity of fuel.

These facts are more clearly brought out by the approximate curves given in Fig. 7, which give the horsepower required, and horsepower available at various speeds for a fast reconnaissance type of aeroplane of refined design. The full lines give the power available for a fixed-blade propeller; the dotted lines for a variable-angle blade. It is assumed that the propeller was designed for maximum efficiency at the high speed of the aeroplane.

The most evident gain made by using the variable pitch as observed from the curves is the

increased reserve horsepower available for climbing. This particular assumed aeroplane, with full load, climbs:

With fixed blade: 650 ft. the first minute.

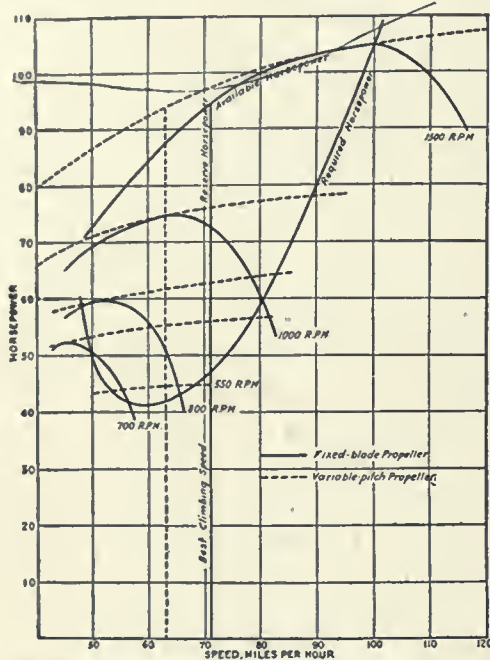

Fig. 7—Performance curves for reconnaissance type of aeroplane

With variable-pitch blade: 715 ft. the first minute.

The increase in the radius of action is very great, the greatest radius of action being ob-

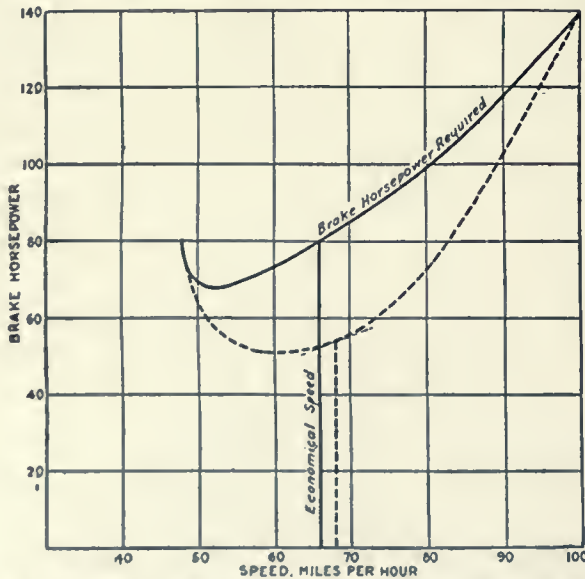

Fig. 8—Showing economical speeds of aeroplanes with fixed-blade (full lines) and variable-blade (dotted lines) propellers

tained when flying at the economical speed of the aeroplane. Figure 8 shows the economical speed in each case.

On one filling of the gasoline tanks the fixed

blade would carry the machine about 690 miles in 10½ hours. The variable-pitch blade would carry the same machine a distance of about 1050 miles in 15½ hours. (Were this machine driven at full power it could go but 600 miles with either propeller.)

These curves, while only approximate, will at least give some indication as to the value of a variable-angle propeller, especially where great distances are to be covered.

The greater efficiency of the variable pitch would be of value in giving increased climbing

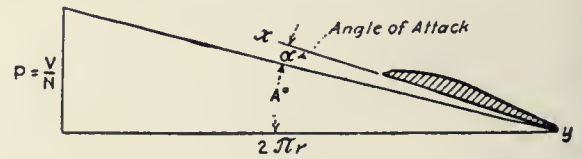

Fig. 9

ability at high altitudes and the possibility of reaching greater heights with a given machine.

Another feature possible, of secondary importance, in a variable-pitch blade is that it can be rotated to give a large negative angle of attack, or possibly reversed, when the aeroplane is on the ground making a landing, thus serving as a brake and cutting down the distance the machine rolls on the ground.

APPENDIX

The weight of assumed aeroplane fully loaded is 2400 lbs. The brake horsepower of engine is as given in Fig. 11. The fuel capacity is six hours at full power.

If A denotes the angle that the helix line makes with the base line, Fig. 9, V the translational velocity in feet per second and N the propeller speed in revolutions per second, then the distance advanced each revolution, neglecting slip, is $(V \div N)$ ft., which is the effective pitch of the propeller.

Suppose the chord XY of the blade section at any radius V , makes an angle a with the helix line, Fig. 9. Angle a is called the angle of attack of the section. As $(V \div N)$ changes owing to a variation in either V or N , or in both the blade section will have a varying angle of attack, an increase in $(V \div N)$ decreasing the angle of attack and vice versa.

The efficiency of such an element is expressed by

$$c = \frac{\tan A}{\tan (A + G)}$$

where G is the gliding angle, which is a function of the angle of attack and varies with the

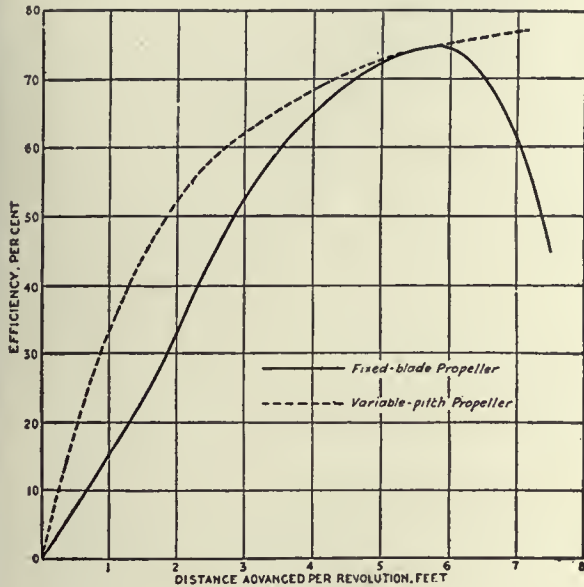

Fig. 10

type of section employed. With the usual section used in propeller design G is a minimum when the angle of attack is about 4 deg. It

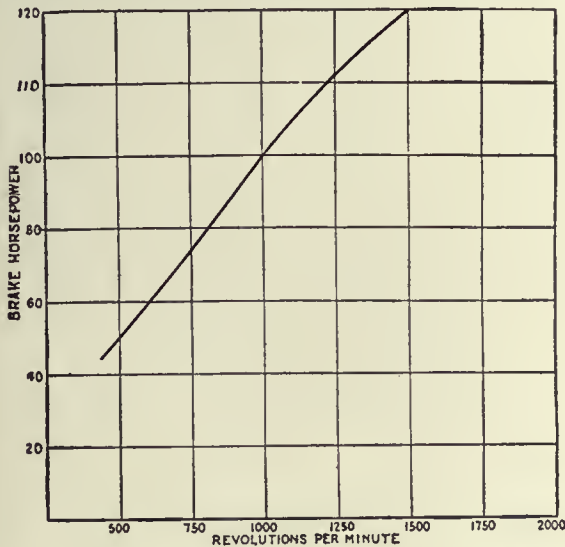

Fig. 11—Assumed brake horsepower of Engine Driving variable-pitch propeller

would therefore be advantageous from the viewpoint of efficiency of the section to keep the angle of attack at 4 deg. throughout the speed of the aeroplane.

This can be accomplished by means of a flexible blade whose pitch angles could be changed a varying amount from the tip of the blade to the root or hub section. Such a blade is out of the question in the light of present day practice. A good approximation to such a blade could be more simply had by rotating the blade about its axis perpendicular to the shaft. With the usual type of section employed the approximation is good as the value of G does not change greatly for a degree or so on either side of the best angle of attack. A mean value for the angle of attack could therefore be found giving practically the same efficiency as though all the sections were at the best angle of attack.

Fig. 10 shows curves in which efficiency of a propeller is plotted against $(V \div N)$. The full line gives the efficiency for a fixed blade, the dotted line the efficiency of the same blade were the angle of attack kept at approximately 4 deg. It is assumed that the fixed-blade propeller was designed for a maximum efficiency at a value of $(V \div N)$, of about 6 ft.

Propeller Stresses

In connection with the subject of propellers, it may be of interest to give a brief review of the variation of stress that occurs in a propeller blade under an assumed condition of flight.

The blades of a propeller are subject to the following stresses when an aeroplane is in any but a straight-line flight:

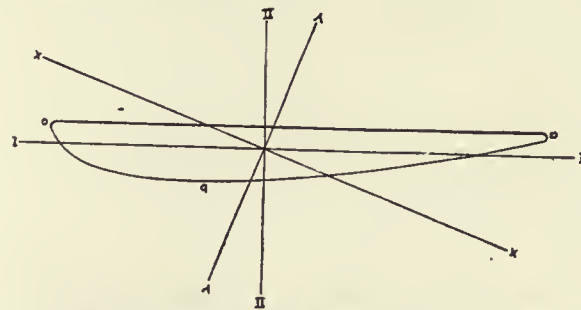

Fig. 12—Points of maximum propeller stress

1. *Shear* due to aerodynamical forces.
2. *Torsion* due to the distance between the center of gravity of the blade section and the point of application of the resultant of the air reactions.
3. *Tension* due to centrifugal force.

4. *Steady bending* due to aerodynamic forces; torque and thrust imposing a distributed load on the blade, the hub being the fixed point of support.

5. *Reverse bending* due to gyroscopic forces, which occurs only when the aeroplane has rotation about an axis, as in making a turn or pulling out of a dive. As a matter of fact, an aeroplane is continually turning to some extent if the flight be in disturbed air.

Each of these forces produces a maximum stress of tension and compression in different parts of the blade, hence the resultant fiber stress at any point will be equal to the algebraic sum of the individual stresses at that point.

It is sufficient to calculate the stress at the points *a*, *b*, *c*, (Fig. 12) along the blade, as these points will be those of maximum stress.

The shear in any case is small and can be neglected in design. The torsion is also small. In good designs, when the thrust is great, the point of application of the air reactions is but little removed from the axis passing through the center of gravity of the section.

The curves of stress given are for a three-blade propeller of about 8½ ft. diameter, 5 ft. pitch, absorbing 150 h.p. at 1300 r.p.m. The

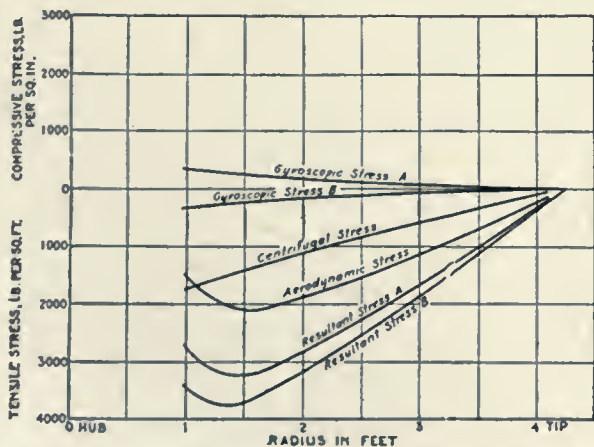

Fig. 13—Fiber stress in propeller blade at point *a* (See Fig. 12)

curves are not accurate, as they are intended merely to give a general idea of the order of magnitude of the stresses likely to occur in such a propeller.

The stress caused by centrifugal force is uniform over any section of the blade and varies in intensity at points along the blade, as shown approximately in Figs. 13, 14 and 15.

Steady bending due to aerodynamic forces is caused by torque and thrust. These forces act along *X—X* and *Y—Y*, respectively for any section, such as shown in Fig. 12. When resolved along *I—I* and *II—II* they induce bending moments that cause the fiber stress as shown in Figs. 13, 14 and 15.

Gyroscopic moments are only induced when the aeroplane is changing its direction of flight. In order to estimate the stress set up in the blades an assumption must be made as to the angular velocity of the propeller axis; that is, as to the precession. There is some question as to the assumption it is reasonable to make in computing the stresses. The type of aeroplane, size and disposition of the larger masses, such as engines, etc., will affect the rate at which a machine can be turned in flight. In general, the angular velocity in yaw will not greatly exceed 0.35 radians per second. It must be remembered, however, that a steeply-banked turn also involves rotation in pitch.

The maximum angular velocity attained in coming out of a steep dive can be estimated from the characteristics of the aeroplane and the factor of safety, which determine the maximum

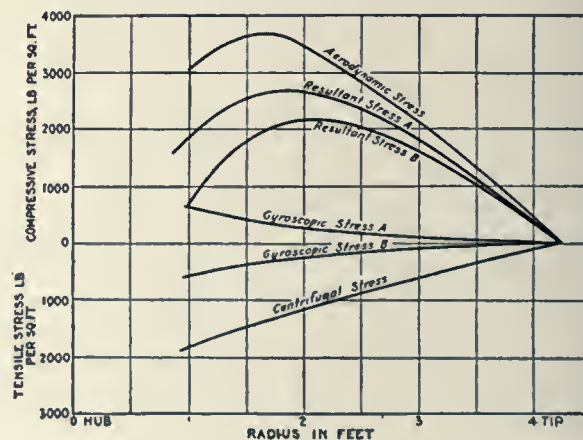

Fig. 14—Stress in propeller blade at point *b* (See Fig. 12)

high speed attainable and the radius of curvature of the path along which it is possible to pull the machine out of its dive safely. A safe value for the angular velocity in pitch for the usual type of present-day aeroplanes is about one radian per second. Loops have been turned in about 6 seconds, which gives about the value mentioned of the angular velocity.

A precession of one radian per second at the

normal speed of the engine should therefore be assumed in computing the stresses.

The stresses set up by gyroscopic forces are alternating, changing in sign (tension to compression) twice in each revolution of the propeller about its axis.

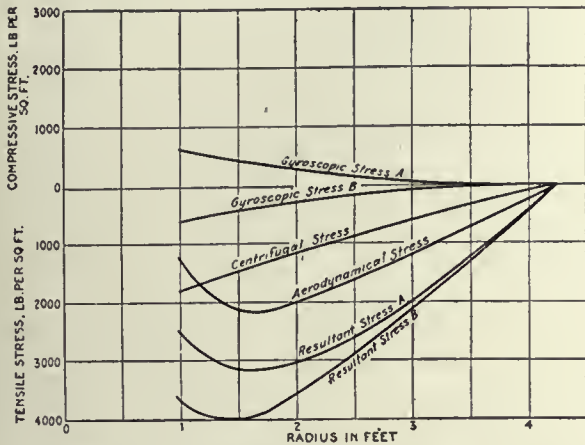

Fig. 15—Stress in propeller blade at point *c* (See Fig. 12)

The fiber stress caused by the gyroscopic moments is given in Figs. 13, 14 and 15. Algebraically adding the fiber stress at the three points chosen gives the approximate value of the resultant fiber stress at those points, as shown in the same figures.

It will be noticed that the maximum stresses occur at some distance out from the hub. To insure a good wearing blade, which will stand up under the necessarily hard usage given it in the field, a factor of safety of not less than 5 is suggested as being the minimum consistent with requirements when the three principal stresses are taken into consideration.

Suggestions for Improvements in Design

These suggestions on powerplants are based on the experience of the First Aero Squadron, United States Army, in the field.

It is considered extremely poor practice to use shims under caps of crankpin and crankshaft bearings.

Many American crankcases are not sufficiently rigid in construction. It is believed that crankcase castings are not designed and built, in this country, with sufficient care. Some of the jigs for boring crankshaft and camshaft bearing seats are not so accurate as desirable.

In some cases it has been found that pistons are not of uniform weight, and are not carefully made.

Lack of interchangeability of parts and *careless workmanship* have been great faults in this country.

OILING SYSTEM

This should be by pressure to all important bearings, preferably from a gear pump. Screens should be provided to protect the suction pumps. For engines that have push-rod and rocker-arm valve mechanism, means should be provided to reduce the friction on the exhaust-valve rocker-arm bearing, especially if the valves are more than $1\frac{1}{4}$ in. diameter.

IGNITION

All military aeroplanes, except possibly the pursuit type, should have two complete and independent ignition systems.

Engines larger than 140 h.p. should have a booster system for starting on battery spark, if a starter is not provided.

It is believed that our magnetos would have much longer life if a more suitable shock-absorbing device between the driving gear and the magneto shaft were provided. A magneto mounting should be machined so that the magneto shaft will be exactly in line with its driving shaft; dowel pins and dowel-pin holes to preserve this alignment should be provided. No shims should be used here. We have had considerable trouble because of non-uniform and warped carbon brushes.

FUEL SUPPLY

Carbureters should be located in such a way that oil, water and impurities cannot enter them. They should be supported from the engine and not from the frame work of the aeroplane. They should be supported independently of the intake manifolds, if practicable.

Gaskets for connections in intake manifolds should be as thin as practicable. Manifolds built of copper, brazed, or of steel, welded, are considered preferable to cast manifolds. Steel is considered preferable, but should, of course, be heat treated after welding.

It is urged that more study and care should be put into the design relating to shape and finish of the interior of intake manifolds and passages. It is believed, in this connection, that much greater efficiency can be obtained by attention to fluid flow.

COOLING SYSTEM

Radiators should preferably be placed at the leading edge of the upper wing, the header being shaped so as to form part of this leading edge. If it is necessary to place the radiator

between the engine and the propeller, the radiator should be circular. The radiator should be provided with a sufficient number of points of support to prevent deformation of the shell owing to shocks on landing.

Care should be taken with the alignment of tubes at the connections in the water-circulating system. A ring reinforcement might be welded to a flanged end of the thin tubing and the face machined so as to make a good fit to the cylinder jacket. It is considered bad practice to expand thin tubing.

Memoranda:

CHAPTER XX

METHODS OF MEASURING AIRCRAFT PERFORMANCES

BY CAPT. H. T. TIZARD, R.F.C.

Aeroplane Testing

The accurate testing of aeroplanes is one of the many branches of aeronautics which have been greatly developed during the war, and especially during the last year. For some months after the war began a climb of 3,000 to 5,000 ft. by aneroid and a run over a speed course was considered quite a sufficient test of a new aeroplane; now we all realize that for military reasons certainly, and probably for commercial reasons in the future, it is the performance of a machine at far greater heights with which we are mainly concerned. In this paper I propose to give a short general account of some of the methods of testing now in use at the Testing Squadron of the Royal Flying Corps, and to indicate the way in which results of actual tests may be reduced, so as to represent as accurately as possible the performance of a machine independently of abnormal weather conditions, and of the time of the year. For obvious reasons full details of the tests and methods employed cannot yet be given. So far as England is concerned, I believe that the general principles of what may be called the scientific testing of aeroplanes were first laid down at the Royal Aircraft Factory. Our methods of reduction were based on theirs to a considerable extent, with modifications that were agreed upon between us; they have been still further modified since, and recently a joint discussion of the points at issue has led to the naval and military tests being coordinated, so that all official tests are now reduced to the same standard. It should be emphasized that once the methods are thought out scientific testing does not really demand any high degree of scientific knowledge; in the end the accuracy of the results really depends upon the flyer, who must be pre-

pared to exercise a care and patience unnecessary in ordinary flying. Get careful flyers whose judgment and reliability you can trust and your task is comparatively easy; get careless flyers and it is impossible.

At the outset it may be useful to point out by an example the nature of the problems that arise in aeroplane testing. Suppose that it is desired to find out which of two wing sections is most suitable for a given aeroplane. The aeroplane is tested with one set of wings, which are then replaced by the other set and the tests repeated some days later. The results might be expressed thus:

	A Wings.	B Wings.
Speed at 10,000 ft.	90 m.p.h.	93 m.p.h.
Rate of climb at 10,000 ft.	250 ft. a minute.	300 ft. a minute.

Now, the intelligent designer knows, or soon will know, that, firstly, an aneroid may indicate extremely misleading "heights"; and, secondly, that even if the actual height above the ground is the same in the two tests, the actual conditions of atmospheric pressure and temperature may have been very different on the two days. He will therefore say, What does that 10,000 mean? Do you mean that your aneroid read 10,000 ft., or do you mean 10,000 ft. above the spot you started from, or 10,000 ft. above sea-level? If he proceeds to think a trifle further he will say, What was the *density* of the atmosphere at your 10,000 ft.; was it the *same* in the two tests? If not, the results do not convey much. There he will touch the keynote of the whole problem, for it is on the density of the atmosphere that the whole performance of an aeroplane depends; the power of the engine and the efficiency of the machine depends essentially on the density, the resistance to the motion of the machine through

the air is proportional to the density, and so finally is the lift on the wings. None of these properties are proportional solely to the pressure of the atmosphere, but to the density—that is, the weight of air actually present in unit volume. It follows that it is essential when comparing the performances of machines to compare them as far as possible under the same conditions of atmospheric *density*, not as is loosely done at the same height above the earth, since the density of the atmosphere at the same height above the earth may vary considerably on different days, and on the same day at different places.

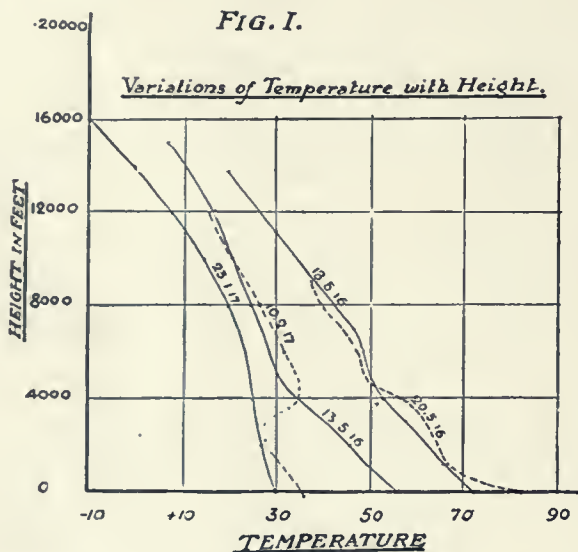

At the same time, in expressing the final results, this principle may be carried too far. Thus, if the speed of a machine were expressed as 40 meters a second at a density of 0.8 kilogs. per cubic meter, the statement, though it may be strictly and scientifically accurate, will convey nothing to 99 per cent. of those directly concerned with the results of the test. The result is rendered intelligible and, indeed, useful by the form, "90 m.p.h. at 10,000 ft.," or whatever it is. With this form of statement, in order that all the statements of results may be consistent and comparative, we must be careful to mean by "10,000 ft." a certain definite density—in fact, the average density of the atmosphere at a height of 10,000 ft. above mean sea-level. This is what the problem of "reduction" of tests boils down to: what is the relation between atmospheric density and height above sea-level?

This knowledge is obtained from meteorological observations. We have collected all the available data, mostly unpublished, with results shown in the following table:—

TABLE I.—*Mean Atmospheric Pressure, Temperature and Density at various Heights above Sea-level.*

Height in Kiloms.	Height in equivalent feet.	Mean pressure in millibars.	Mean temp. in absolute degrees Centigrade.	Mean density in kgm. per cubic meter.
0	0	1,014	282	1.253
1	3,280	900	278	1.128
2	6,560	795	273	1.014
3	9,840	699	268	0.909
4	13,120	615	262	0.818
5	16,400	568	255	0.735
6	19,680	469	248	0.658
7	22,960	407	241	0.589

These are the mean results of a long series of actual observations made mainly by Dr. J. S. Dines. It is convenient to choose some density as standard, call it unity, and refer to all other densities as fractions or percentages of this "standard density." We have taken, in conformity with the R.A.F., the density of dry air at 760 mm. pressure and 16° C. as our *standard density*; it is 1.221 kilog. per cubic meter. The reason this standard has been taken is that the air speed indicators in use are so constructed as to read correctly at this density, assuring the law: $p = \frac{1}{2}\rho V^2$, where V is the air speed, p the pressure obtained, ρ the standard density.

In some ways it would doubtless be more convenient to take the average density at sea-level as the standard density, but it does not really matter what you take so long as you make your units quite clear. Translated into feet, and fraction of the standard density, the above table becomes:—

TABLE II.

Height in feet.	Percentage of standard density.	Height in feet.	Percentage of standard density.	Height in feet.	Percentage of standard density.
0	102.6	7,000	81.9	15,000	63.0
1,000	99.4	8,000	79.2	16,000	61.1
2,000	96.3	9,000	76.5	†16,500	60.1
3,000	93.2	†10,000	74.0	17,000	59.1
4,000	90.3	11,000	71.7	18,000	57.1
5,000	87.4	12,000	69.5	19,000	55.2
6,000	84.6	†13,000	67.3	20,000	53.3
†6,500	83.3	14,000	65.2		

Let us briefly consider what these figures mean. For example, we say that the density at 10,000 ft. is 74 per cent. of our standard density, but it is not meant that at 10,000 ft. above mean sea level the atmospheric density will always be 74 per cent. of the standard density. Unfortunately for aeroplane tests this is far from true. The atmospheric density at any particular height may vary considerably from season to season, from day to day, and even from hour to hour; what we do mean is that if the density at 10,000 ft. could be measured every day, then the *average* of the results would be, as closely as we can tell at present, 74 per cent. of the standard density.

The above table may therefore be taken to represent the conditions prevailing in a "normal" or "standard" atmosphere, and we endeavor, in order to obtain a strict basis of comparison, to reduce all observed aeroplane performances to this standard atmosphere, *i.e.*, to express the final results as the performance which may be expected of the aeroplane on a day on which the atmospheric density at every point is equal to the average density at the point. Some days the aeroplane may put up a better performance, some days a worse, but on the average, if the engine power and other characteristics of the aeroplane remain the same, its performance will be that given.

It must be remembered that a standard atmosphere is a very abnormal occurrence; besides changes in density there may occur up-and-down air currents which exaggerate or diminish the performance of an aeroplane, and which must be taken carefully into account. They show themselves in an otherwise unaccountable increase or decrease in rate of climb or in full speed flying level at a particular height.

We now pass to the actual tests, beginning with a description of the observations which have to be made and thereafter to the instruments necessary. The tests resolve themselves mainly into (a) A climbing test at the maximum rate of climb for the machine. (b) Speed tests at various heights from the "ground" or some other agreed low level upwards.

Experience agrees with theory in showing

that the best climb is obtained by keeping that which is frequently called the air speed of an aeroplane, *viz.*, the indications of the ordinary air speed indicator, nearly constant whatever the height—in other words, ρV^2 is kept constant. We can look at this in this way. There is a limiting height for every aeroplane above which it cannot climb; at this limiting height, called the ceiling of the machine, there is only one speed at which the aeroplane will fly level, at any other air speed higher or lower it will descend. Suppose this speed be 55 m.p.h. on the air speed indicator. Then the best rate of climb from the ground is obtained by keeping the speed of the machine to a steady indicated 55 m.p.h. Fortunately a variation in the speed does not make very much difference to the rate of climb; for instance, a B.E.2c with a maximum rate of climb at 53 m.p.h. climbs just as fast up, say, 5,000 ft. at about 58 m.p.h. This is fortunate as it requires considerable concentration to keep climbing at a steady air speed, especially with a light scout machine; if the air is at all "bumpy" it is impossible. At great heights the air is usually very steady, and it is much easier to keep to one air speed. It is often difficult to judge the best climbing speed of a new machine; flyers differ very much on this point, as on most. The Testing Squadron, therefore, introduced some time ago a rate of climb indicator intended to show the pilot when he is climbing at the maximum rate. It consists of a thermos flask, communicating with the outer air through a thermometer tube leak. A liquid pressure gage of small bore indicates the difference of pressure between the inside and outside of the vessel. Now, when climbing, the atmospheric pressure is diminishing steadily; the pressure inside the thermos flask tends therefore to become greater than the outside atmospheric pressure. It goes on increasing until air is being forced out through the thermometer tubing at such a rate that the rate of change of pressure inside the flask is equal to the rate of change of atmospheric pressure due to climbing. When climbing at a maximum rate, therefore, the pressure inside the thermos flask is a maximum. The pilot therefore varies his air speed until the liquid in the gage is as

high as possible, and this is the best climbing speed for the machine.

What observations during the test are necessary in order that the results may be reduced to the standard atmosphere? Firstly, we want the time from the start read at intervals, and the height reached noted at the same time. Here we encounter a difficulty at once, for there is no instrument which records height with accuracy. The aneroid is an old friend now of aeronauts as well as of mountaineers, but although it has

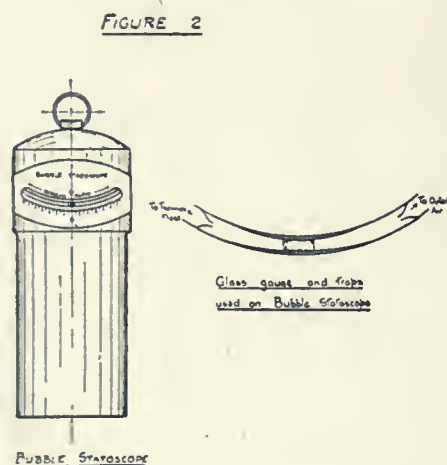

often been tentatively exposed, it is doubtful whether 1 per cent. of those who use it daily realize how extraordinarily rare it is that it ever does what it is supposed to do, that is, indicate the correct height above the ground, or starting place. The faults of the aeroplane aneroid are partly unavoidable and partly due to those who first laid down the conditions of its manufacture. An aneroid is an instrument which in the first place measures only the *pressure* of the surrounding air. Now if p_1 and p_2 are the pressure at two points in the atmosphere, the difference of height between these points is given very closely by the relation, $h = \theta \log_e p_1/p_2$ where θ is the average temperature, expressed in "absolute" degrees, of the air between the two points. It is obvious that if we wish to graduate an aneroid in feet we must choose arbitrarily some value for θ . The temperature that was originally chosen for aeroplane aneroids was 50° F. or 10° C. An aneroid, as now graduated, will therefore only read the correct height in feet if the atmosphere has a uniform temperature of 50° F. from the ground up-

wards, and it will be the more inaccurate the greater the average temperature between the ground and the height reached differs from 50° F. Unfortunately 50° F. is much too high an average temperature; to take an extreme example, it is only on the hottest days in summer, and even then very rarely, that the average temperature between the ground and 20,000 ft. will be as high as 50° F. On these very rare occasions an aneroid will read approximately correctly at high altitudes; otherwise it will always read too high. In winter it may read on cold days 2,000 ft. too high at 16,000 ft., *i.e.*, it will indicate a height of 16,000 ft. when the real height is only 14,000 ft. It is always necessary, therefore, to "correct" the aneroid readings for temperature. The equation

$$H = \frac{273 + t}{283} \cdot h.$$

gives us the necessary correction. Here H is the true difference in height between any two points, t the average temperature in degrees Centigrade between the points, and h the difference in height indicated by aneroid. It is convenient to draw a curve showing the necessary correction factors at different temperatures, some of which are given below:—

TABLE III.—*Aneroid Correction Factors.*

Temperature $^\circ \text{ F.}$	Correction factor.	Temperature $^\circ \text{ F.}$	Correction factor.
70	1.040	10	0.922
50	1.000	—10	0.833
30	0.961		

For example if a climb is made through 1,000 ft. by aneroid and the average temperature is 10° F. , the actual distance in feet is only $1,000 \times 0.922 = 922 \text{ ft.}$ The above equation is probably quite accurate enough for small differences of height—up to 1,000 ft. say—and approximately so for bigger differences. The magnitude of the correction which may be necessary shows how important it is that observations of temperature should be made during every test. For this purpose a special thermometer is attached to a strut of the machine, well away from the *fuselage*, and so clear of any warm air which may come from the engine.

The French, I believe, do not measure temperature, but note the ground temperature at the start of a test, and assume a uniform fall of temperature with height. This, undoubtedly, may lead to serious errors. The change of temperature with height is usually very irregular, and only becomes fairly regular at heights well above 10,000 ft.

The aneroid being what it is, one soon comes to the conclusion that the only way to make use of it in aeroplane tests is to treat it purely as a pressure instrument. For this reason it is best to do away with the zero adjustment for all test purposes and lock the instrument so that the zero point on the height scale corresponds to the standard atmospheric pressure of 29.9 ins. or 760 mm. of mercury. Every other height then corresponds to a definite pressure; for instance, the locked aneroid reads 5,000 ft. when the atmospheric pressure is 24.88 ins., and 10,000 ft. when it is 20.70 ins., and so on. If the temperature is noted at the same time as the aneroid reading, we then know both the atmospheric pressure and temperature at the point, and hence the density can be calculated, or, more conveniently, read off curves drawn for the purpose. The observations necessary (after noting the gross aeroplane weight and net or useful weight carried) are therefore: (i) Aneroid height every 1,000 ft.; (ii) time which has elapsed from the start of the climb; and (iii) temperature. To these should be added also (iv) the air speed and (v) engine revolutions at frequent intervals. The observed times are then plotted on squared paper against the aneroid heights and a curve drawn through them. From this curve the rate of climb at any part (also in aneroid feet) can be obtained by measuring the tangent to the curve at the point. This is done for every 1,000 ft. by aneroid. The *true* rate of climb is then obtained by multiplying the aneroid rate by the correction factor corresponding to the observed temperature. These true rates are then plotted afresh against standard heights, and from this curve we can obtain the rate of climb corresponding to the standard heights, 1,000, 2,000, 3,000, etc. Knowing the change of rate of climb with height, the time to any required height is best

obtained by graphical integration. The table below gives the results of an actual test.

At least two climbing tests of every new machine are carried out up to 16,000 ft. or over by aneroid. If time permits three or more tests are made. The final results given are the average of the tests and represent as closely as possible the performance on a standard day, with temperature effects, up and down currents and other errors eliminated.

If we produce the rate of climb curve upwards it cuts the height axis at a point at which the rate of climb would be zero, and therefore the limit of climb reached. This is the "ceiling" of the machine.

SPEEDS

His 16,000 ft., or whatever it is, reached, the flyer's next duty is to measure the speed flying level by air speed indicator at regular intervals of height (generally every 2,000 ft.) from the highest point downwards. To do this, he requires a sensitive instrument which will tell him when he is flying level. The aneroid is quite useless for this purpose, and a "statoscope" is used. The principle of this instrument is really the same as that of a climb meter. It consists of a thermos flask connected to a small glass gage, slightly curved, but placed about horizontally (see Fig. 2). In this gage is a small drop of liquid, and at either end are two glass traps which prevent the liquid from escaping either into the outside air or into the thermos flask. As the machine ascends and the atmospheric pressure being smaller, and the pressure in the flask being higher than the external pressure, the liquid is pushed up to the right hand trap, where it breaks, allowing the air to escape. On descending the reverse happens; the liquid travels to the left, breaks, and air enters the flask. When flying truly level the drop remains stationary, moving neither up nor down. The instrument is made by the British Wright Co.

The flyer or the observer notes the maximum speed by the air speed indicator—*i.e.*, the speed at full engine throttle. At one or more heights, also, he observes the speeds at various positions of the throttle down to the minimum speed

which will keep the machine flying at the height in question. The petrol consumption and the engine revolutions are noted at the same time, as well, of course, as the aneroid height and temperature. Accurate observation of speeds needs very careful flying—in fact much more so than in climbing tests. If the air is at all bumpy observations are necessarily subject to much greater error, since the machine is always accelerating and decelerating. The best way to carry out the test seems to be as follows. The machine is flown first just down hill and then just up hill, and the air speeds noted. This

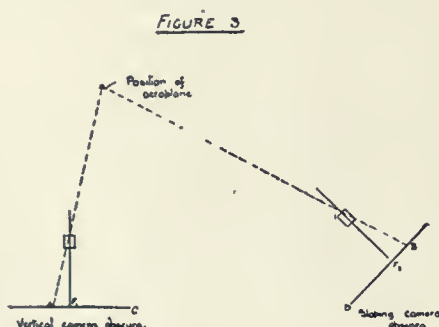

will give a small range between which the real level speed must lie. The flyer must then keep the speed as steadily as possible on a reading midway between these limits, and watch the statoscope with his other eye. If it shows steady movement, one way or the other, the air speed must be altered accordingly by 1 m.p.h. In this way it is always possible at heights where the air is steady to obtain the reading correct at any rate to 1 m.p.h., even with light machines, provided always sufficient patience is exercised. The r.p.m. at this speed are then noted.

One difficulty, however, cannot be avoided. If at any height there is a steady up or down air current, then though the air may appear calm, *i.e.*, there may be no "bumps," the air speed indicator reading may be wrong, since to keep the machine *level* in an up current it is necessary to fly slightly down hill relatively to the air. Such unavoidable errors are, however, eliminated to a large extent by the method of taking speeds every 2,000 ft., and finally averaging the results.

We must now consider how the true speed of the aeroplane is deduced from the reading of the air speed indicator. It is well known that

an air speed indicator reads too low at great heights—for example, if it reads 70 m.p.h. at 8,000 ft. the real speed of the machine through the air is nearer 80 m.p.h. The reason for this is that the indicator, like the aneroid, is only a pressure gage—a sensitive pressure gage, in fact, which registers the difference of pressure between the air in a tube with its open end pointing forward along the lines of flight of the machine, and the real pressure (the static pressure) of the external air. This difference of pressure is as nearly as we can judge by experiment— $\frac{1}{2} \rho V^2$ (where ρ is the density of the air and V the speed of the machine), provided that the open end of the tube is well clear of wings, fuselage, etc., and so is not affected by eddies and other disturbances. Now, assuming this law, air speed indicators are graduated to read correctly, as I have said above, at a density of 1.221 kgm. per cubic meter, which we have taken as our standard density and called "unity." It corresponds on an average to a height of about 800 feet above sea level.

Then suppose the real air speed of an aeroplane at a height of " h " feet is V m.p.h., and the indicated air speed is 70 m.p.h., this means that the excess pressure in the tube due to the speed is proportional to 1×70^2 ,

$$\text{or } \rho \times V^2 = 1 \times 70^2,$$

where ρ is the density at the height in question, expressed as a fraction of the standard density. To correct the observed speed, we therefore divide the reading by the square root of the density. Thus, observation of the maximum speed of an aeroplane at a height of 8,000 ft. by the locked aneroid gave 80 m.p.h. on the indicator, the temperature being 31° Fahr. From the curve we find that the density corresponding to 8,000 ft. and 31° is 0.85 of standard density. The corrected air speed is therefore:

$$= \frac{80}{\sqrt{.85}} = 86.7 \text{ m.p.h.}$$

This "corrected" air speed will only be true if the above law holds, that is to say, if there are no disturbances due to the pressure head being in close proximity to struts or wings. It is always necessary to find out the magnitude

of this possible error, that is, to calculate the air speed meter, and the only way to do this is to measure a real air speed at some reasonable altitude for easy observation of the aeroplane by actual timed observations from the ground, and from these timed results check those deduced from the air speed indicator readings. This calibration is the most important and difficult test of all, since on the accuracy of the results depends the accuracy of all the other speed measurements. It can either be done by speed trials over a speed course close to the ground, or when the aeroplane is flying at a considerable height above the ground. In the Testing Squadron we have always attached much more importance to the latter method, mainly because the conditions approximate more to the conditions of the ordinary air speed measurements at different heights, and because the weather conditions are much steadier and the flyer can devote more attention to flying the machine at a constant air speed than he can when very close to the ground.

One method is to use two camera obscuras, one of which points vertically upwards and the other is set up sloping towards the vertical camera. At one important testing center the cameras are a mile apart, and the angle of the sloping camera is 45° . By this arrangement, if an aeroplane is directly over the vertical camera it will be seen in the field of the sloping camera if its height is anywhere between 1,500 and 15,000 feet, although at very great heights it would be too indistinct for measurements except on a very clear day. The height the tests are usually carried out is 4,000 ft. to 6,000 ft.

The aeroplane is flown as nearly as possible directly over the vertical camera and in a direction approximately at right angles to the line joining the two cameras. The pilot flies in as straight a line and at as constant an air speed as he can. Observers in the two cameras dot in the position of the aeroplane every second. A line is drawn on the tables of each camera pointing directly towards the other camera, so that if the image of the aeroplane is seen to cross the lines in the one camera it crosses the line in the other simultaneously. From these observations it is possible to calculate the height

of the aeroplane with considerable accuracy; the error can be brought down to less than 1 part in a 1,000 with care. Knowing the height, we can then calculate the speed over the ground of the aeroplane by measuring the average distance on the paper passed over per second by the image in the vertical camera. If x inches is this distance, and f the focal length of the lens, the ground speed is $x \times h/f$ feet per second.

It is necessary to know also the speed and direction of the wind at the height of the test. For this purpose the pilot or his observer fires a smoke puff slightly upwards when over the cameras, and the observer in the vertical camera dots in its trail every second. The height of the smoke puff is assumed to be the same as that of the aeroplane—it probably does not differ from this enough to introduce any appreciable error in the results. The true speed through the air is then found graphically as shown in Fig. 4. Here the length AB represents the ground speed of the aeroplane as measured in the camera and CB represents on the same scale the velocity and direction of the wind. The length AC represents, also on the same scale, the true air speed of the machine.

The tests are done in any direction relative to the wind, and generally at three air speeds, four runs being made at each air speed.

The advantages of this method are:

- (1) Being well above the earth the pilot can devote his whole attention to the test.
- (2) Within reasonable limits any height can be chosen, so that it is generally possible to find a height at which the wind is steady.
- (3) It does not matter if the pilot does not fly along a level path so long as he does so approximately. What is more important is that he should fly at a constant air speed.
- (4) It is not necessary that there should be any communication between the two cameras, although it is convenient. The two tracks are made quite independently, and synchronized afterwards from the knowledge that the image must have passed over the center line simultaneously in the two cameras.

The main disadvantage is that somewhat elaborate apparatus is necessary, but this is of

not much importance in a permanent testing station.

There are often periods in war time, however, when an aeroplane has to be tested quickly, and low cloud layers and other causes prevent the camera test from being carried out. It is then necessary to rely on measurements of speeds near the ground for the calibration of the air speed indicator. In this method the aeroplane is flown about 10 ft. off the ground, and is timed over a measured run. There are two observers, one at each end of the course: when the aeroplane passes the starting point the observer

FIGURE 4

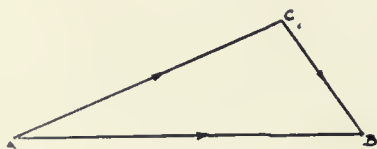

A.B represents the measured speed of the aeroplane on the ground.

CB on the same scale represents the Velocity and direction of the wind.

Therefore AC represents the real speed of the aeroplane through the air.

sends a signal and starts his stop-watch simultaneously; the second observer starts his stop-watch directly he hears the signal, and in his turn sends a signal and stops his watch when the aeroplane passes the finishing point. By this double timing, errors due to the so-called "reaction time" of the observers are practically eliminated, for the observer at the end of the course tends to *start* his watch late, while the first observer *stops* his late. The mean of the two observations gives the real time. Four runs, two each up and down the course, are done at each air speed, the pilot or his observer noting carefully the average air speed during the run. Observations of the atmospheric pressure and temperature from which the density can be obtained are also taken. The average strength and direction of the wind during each trial are noted from a small direct reading (or recording) anemometer and the speed corrected in the same way as in the camera tests. If there is a

strong cross wind the aeroplane may have to be pointed at a considerable angle to the course, and this makes the test a very difficult one to carry out well. Generally speaking, it is only reliable when the wind is quite light, not more, at any rate, than 10 m.p.h. Even this is too strong if it is a cross wind.

A further difficulty is that at high speeds, over 100 m.p.h., an aeroplane may take quite a considerable time to accelerate up to a steady speed, and so it must fly level for a long distance each end before reaching the actual course. At the testing station previously alluded to the course is a mile long, and there is a clear half-mile or more at each end, but it is doubtful whether even this distance is enough for the machine to attain steady speed before the starting point. Finally, the flyer of a single-seater is generally too busy watching the ground to do more than glance at his air speed indicator more than a few times during the run. Doubtless it would be better in such a case to use some form of recording air speed instrument, although then other difficulties would arise.

Having got the true air speed from camera or speed course tests, and knowing the density at the height at which the test was carried out, we obtain what the air speed indicator should have read by multiplying the measured air speed by the square root of the density. By comparing this with the actual reading of the indicator we obtain the necessary correction. The whole procedure may be shown best by a table giving part of the results of a camera test made at the beginning of the year.

A summary of the complete speed tests may now be given. Firstly, the air speed and engine revolutions are noted flying level at full throttle every 2,000 feet approximately by aneroid. From the aneroid reading and temperature observation at each height the density is obtained. The reading of the air speed indicator is then first corrected for instrumental errors by adding or subtracting the correction found by calibration tests over the cameras or speed course. This number is then again corrected for height by dividing by the square root of the density. The result should give the true air speed, subject, of course, to errors of obser-

vation. The numbers so obtained are plotted against the "standard" heights, *i.e.*, the average height in feet corresponding to the density during the test. A smooth curve is then drawn through the points and the air speeds at standard heights of 3,000, 6,500, 10,000, 13,000 and 16,500 read off the curve. These heights are chosen because they correspond closely with 1,

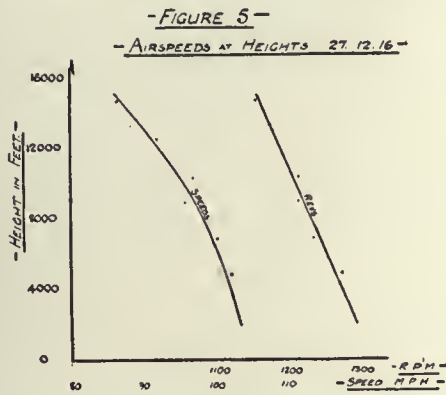

2, 3, etc., kilometers. The indicated engine revolutions are also plotted against the standard heights, because these observations form a check on the reliability of the results; also the ratio of speed to engine revolutions at different heights may give valuable information with regard to the propeller.

Table VI gives complete results of one of our tests of air speed at heights. The table refers to the same machine as Table V, which gives the results of calibration tests of the air speed indicator. Fig. 5 shows the smooth curve drawn from the calculated data, the actual air speeds calculated from the observations being shown by crosses, while the observed engine revolutions at the same heights are marked in by dots. Fig. 6 gives another example, where the observations were very good; the air speeds and r.p.m. lie very closely on a smooth curve except at one point (about 10,000 ft.), where they were probably affected by a downward current of air.

In a brief paper it is impossible to do more than explain the more important of the "performance" tests of aeroplanes, considered solely as flying machines. For military purposes a number of tests are necessary, some of which cannot easily be reduced to figures. Nor can it be supposed for an instant that the methods outlined here are final; aeroplane testing, like

all other work connected with aeroplanes, is only in its infancy; and as time goes on, and knowledge accumulates, better methods and instruments will be evolved. There are some who lay considerable emphasis on the necessity of every test instrument being self-recording, and although this scheme appears at first sight Utopian and would relieve the pilot of a single-seater of considerable trouble, there are many objections to it when considered in detail, not the least of which is the difficulty of getting new and elaborate instruments made at a time when all manufacturers are fully engaged on other important work. When an observer can be taken I would personally place much more reliance on direct observations at the present time, and one great advantage of direct observation is that the results are *there*, and no time is lost through the failure of a recording instrument to record, a circumstance which is not unknown in practice. So far as we use recording instruments we use them only as a check on direct observations, although we shall probably soon adopt recording air speed indicators for the calibration tests. But whether recording or direct reading instruments are used, it is, as I said before, the flyer

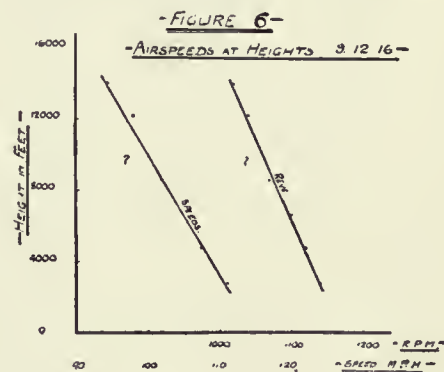

on whom the accuracy of the tests depends. I feel that too great stress cannot be laid on this; he is the man who does most of the experiments, and like all experimenters in every branch of science, he requires training and a great deal of practice. Although the methods themselves may be greatly changed, this much may perhaps be claimed, that the general principles on which they are founded are sound, and will only be altered in detail. The importance of the work can hardly be exaggerated; model experiments are notoriously subject to scale and other cor-

rections, which if not carefully scrutinized may be very misleading, and it is only by accurate full scale work that we can hope to maintain a steady improvement in the efficiency of aeroplanes.

TABLE IV

Machine.....		Date 27/12/16		
Height in Aneroid ft.	Observed temp.	Percentage of standard density	Observed time	Rate of climb in Aneroid ft.
0	36° Fahr.		0.0	
1,000	37° "	101.0	1.0	835
2,000	38° "	97.2	2.10	735
3,000	36° "	94.0	3.70	640
4,000	36° "	90.7	5.40	560
5,000	36° "	87.4	7.25	510
6,000	33° "	84.7	9.40	450
7,000	30° "	82.1	11.90	405
8,000	26° "	79.9	14.25	365
9,000	22° "	77.6	17.00	330
10,000	23° "	74.7	20.25	310
11,000	21° "	72.2	23.60	280
12,000	20° "	69.8	27.40	230
13,000	17° "	67.7	31.90	195
14,000	12° "	65.9	37.90	150
15,000	8° "	64.1	45.25	110

Real rate of climb (corrected for temp.)	Standard height	From curve % of standard density	Time	Rate of climb
814	1,000	99.40	1.20	775
718	2,000	96.30	2.56	685
622	3,000	93.26	4.11	610
544	4,000	90.25	5.85	545
495	5,000	87.35	7.80	490
435	6,000	84.50	9.96	435
389	7,000	81.80	12.40	385
347	8,000	79.16	15.14	345
312	9,000	76.55	18.20	310
294	10,000	74.00	21.61	280
264	11,000	71.70	25.41	245
216	12,000	69.50	29.81	210
182	13,000	67.32	35.13	170
139	14,000	65.17	41.88	130
101	14,500	64.11	46.23	105

TABLE V

Calibration Test of Air Speed Indicator No.....

On.....Machine Date, 24/12/16

Run No.	Measured ground speed	Measured wind speed and direction	Corrected true (= V) air speed	Observed Aneroid height
1	59.1 m.p.h.	31.0 m.p.h. 161.5	89.2	5,100
2	123.4 "	28.6 " 5.5	93.7	5,100
3	62.0 "	32.3 " 168.5	93.8	5,050
4	124.7 "	32.3 " 21.0	95.6	5,000

Observed temp.	Density (= ρ) referred to standard density	Observed air speed	V × √ρ	Correction necessary
31	0.879	80.0	83.6	× 3.6
31	0.879	85.0	87.8	× 2.8
31	0.881	85.0	88.1	× 3.1
31	0.882	86.0	88.8	× 2.8
				Mean × 3.1

TABLE VI

AIR SPEED AT HEIGHTS

27/12/16

Aneroid height	Temp. observed	Standard density	Corresponding Standard height	Observed air speed	Corr. for calibration tests
3,000	39° F.	.935	2,900	95 m.p.h.	98
5,000	35°	.875	4,900	93 "	96
7,000	30°	.821	6,900	88 "	91
9,200	24°	.767	9,000	81 "	84
10,800	19°	.731	10,400	80 "	83
12,800	17°	.682	12,600	72 "	76
13,800	12°	.664	13,400	68 "	72
15,200	8°	.636	14,800	65 "	69

Corr. for density	Observed R.P.M.	Standard height	Air speed	R.P.M.
101½	1,280			
102½	1,280			
100½	1,240	3,000	103.0 m.p.h.	1,290
96	1,220	6,500	100.5 "	1,250
97	1,220	10,000	96.5 "	1,215
92	1,200	13,000	94.5 "	1,180
88½	1,180	15,000	86.0 "	1,160
86½	1,160			

FINAL RESULTS FROM CURVE

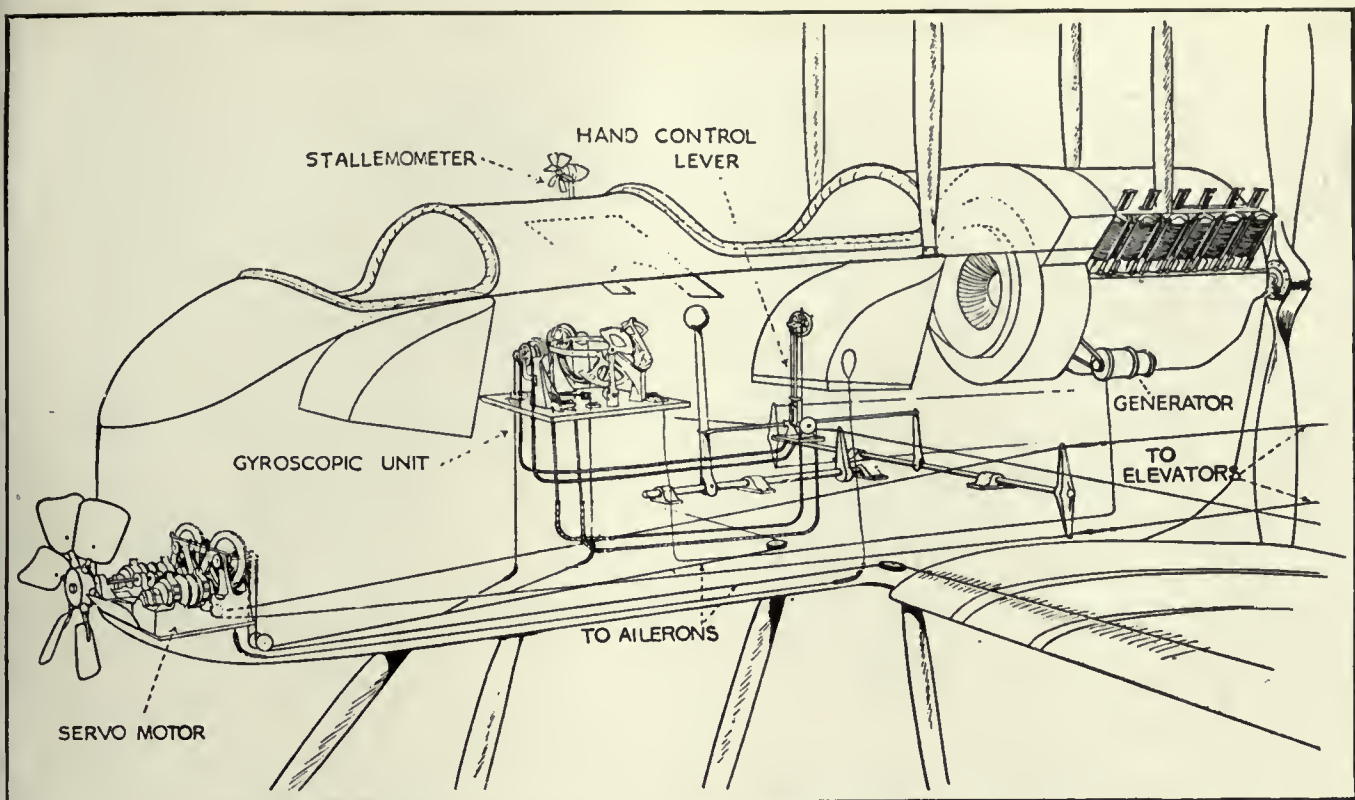

How the Sperry Automatic Pilot is installed on a Voisin battleplane

CHAPTER XXI

THE SPERRY AUTOMATIC PILOT

Incorporating a Gyroscopic Reference Plane and Clinometer for Aeroplanes—Its Application for Military Purposes

BY LAWRENCE B. SPERRY

The efficacy of the Sperry Automatic Pilot in fulfilling its three important functions, as an automatic pilot, a clinometer, and a gyroscopic reference plane, having been demonstrated and established beyond question by numerous actual trials, it will be interesting to note the various military uses to which these functions can be put. Let us consider their applications separately, under the following heads:

- 1—Reconnaissance.
- 2—Fighting in the Air.
- 3—Artillery Regulation.
- 4—Bombardment.

Reconnaissance. In the reconnaissance machine, the Sperry Automatic Pilot, by relieving the aviator of the nervous and physical strain incident to flying, enables him to rest while en route to the area of reconnaissance, so that he can conserve his energy for the more important

military operations that he is shortly to carry out. If wounded, he can go on or return, spurred by the confidence of knowing that his aeroplane does not depend upon his own dexterity, but that of a tireless mechanism. If he finds himself suddenly enveloped in a cloud, he will be spared the incident nervous bewilderment with its resultant effect upon his ability to reach the spot set out for; in this connection he is able to check his position by reading the ever present clinometers on the gyro unit.

At the place to be reconnoitered, the pilot-observer can study the positions below him through his binoculars, without being hindered by the increased effort necessitated by the motion of a less steady aeroplane, and without the distraction of suddenly finding his machine tipped to a large degree, involving a consequent loss of time in again finding the position he was

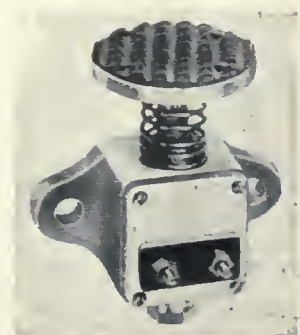

Test Cut Out.



Hand Control Lever

observing, and even though shells might be bursting around him.

He can take his feet off the pedals, perch himself sideways in his seat, and rest his sketching board on the side of the machine, while drawing maps or making notes; these actions being facilitated by the steadiness of the machine. An observed position being worthy of a photograph, he can be sure of securing the desired field in his exposure, due to the machine retaining its relation to the true horizontal and remaining perfectly steady.

Being the observer, as well as the pilot, the aviator can carry out, with an efficiency impossible through the joint action of two individuals acting as pilot and observer, respectively, those

manœuvres in piloting that are necessitated by the situation at hand, as seen through his own eyes as observer. In other words, there are eliminated the inefficiency and loss of time apt to occur when two men are employed, due to misunderstood or badly carried out instructions on the part of the pilot, who is usually above the rank of the observer, and who may have his own ideas as to what should be done.

Owing to the device, the pilot-observer can stand in his seat to review his rear in search of an enemy machine. If attacked, he will have the advantage of increased climbing and manœuvring ability, due to the elimination of an extra passenger and to the unusual efficiency and easy control made possible by the never-tiring Automatic Pilot. With this device the tail of the machine can be slapped up, in order to get in quickly and to stay in the non-fire zone of the enemy, who is perhaps also diving. Thus, with the enemy's landing chassis or planes nicely interposed, the pilot-observer can stand up and take deliberate aim with his rifle or machine-gun, resting the rifle on a part of the steady aeroplane, or steadying the machine-gun in its crutch.

Fighting in the Air. In the single-seater gun-scout, the Automatic Pilot, permitting the selection of a supersensitive, efficient aeroplane, will convert it into a steady gun platform, at the same time bettering the aviator's manœuvring ability. A steady platform means accuracy of



The Anemometer.

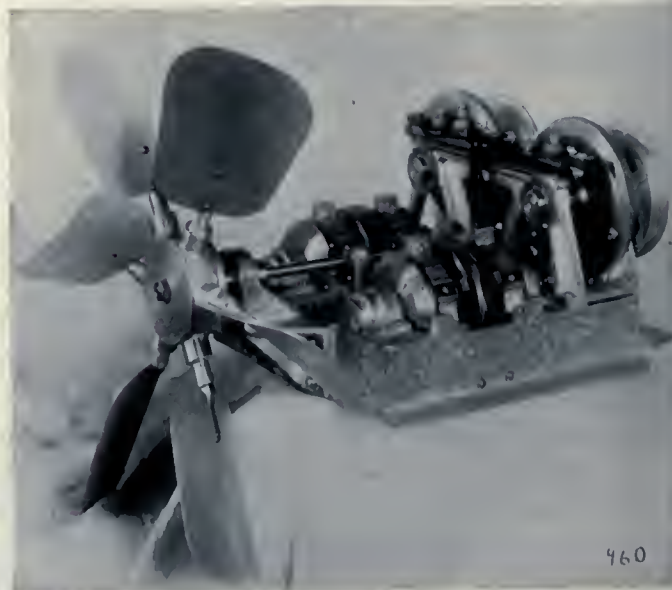

Servo Motor—Cover Removed.

aim and ease in reloading, while, should the gun become jammed, the pilot has a better chance of fixing it without returning to the ground.

Let us turn to the very powerful gun-carrier, where it is thought advisable to carry two men, one sitting in the nacelle, between the two motors, back of the planes; the other in the nose of the same nacelle. On such a machine, the device has the decided advantage of increasing the cone of fire, since the pilot can operate a machine gun in a rearward cone, in the event of the enemy outmaneuvering him, or in the event of his being attacked by two or more machines at once. On approaching combat, with the Automatic Pilot performing the more irksome task of correcting the many disturbances, the aviator, thus freed, can scrutinize his enemy with the view of finding the limits of his non-fire cone, his speed, vulnerable spots in the enemy's craft, and other points that will aid in planning his own maneuvers of attack. This increased freedom on the part of the pilot gives him the chance of spotting with ease the different enemy machines that he is about to attack, thus preventing him, if he is endowed with a sense of proportion, from inadvertently getting into a position where he can do little or no good, since he knows that two enemy machines are four times as formidable as one. It should be borne in mind that the hitherto great physical

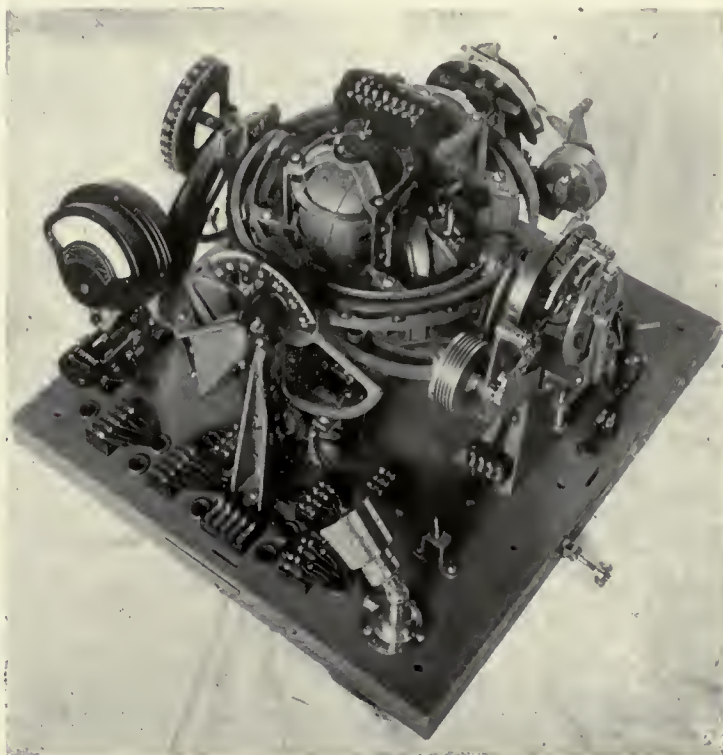

The Gyrosopic unit.

exertion on the part of the pilot in moving large controls is eliminated.

Regulating Artillery Fire. In the machine for regulating artillery fire, the work of the pilot-observer is quite similar to that involved in reconnoitering. He will therefore be aided in a like manner, only instead of the device facilitating the use of the sketching board and note-book, it aids in using the radio or flash signal.

Bombardment. For purposes of bombard-



Aeroplane equipped with Sperry Automatic pilot.

ment, there is the machine of unusually large dimensions, which is capable of more nearly equaling the performance of Zeppelins, so far as staying in the air for long periods is concerned, and at the same time is roomy and is able to carry not only all conveniences in the way of instruments, but a large number of bombs. For operating at decreased radii, there is a small machine.

The evident advantages that the Automatic Pilot secures in bombarding operations are the following:

The facilitating of night-flying.

The accuracy and simplification of bomb-dropping.

The elimination of one man.

The reduction of physical effort on the part of the pilot.

Night flying. The bewilderment that comes on a dark night, due to the pilot's imperfect

sense of horizontality, is accentuated to a high degree when he is unable to secure those visual impressions that he is wont to use in the daytime. At night the pilot must depend for his sense of horizontality, experts tell us, on the reflex actions of certain semi-circular canals located in the interior of the ears and tactile impressions coming from the nerves, particularly those in the soles of the feet and other supporting portions of the body. It is not generally known that these impressions are susceptible to serious error, due to centrifugal force or acceleration pressures, which are capable of reproducing and even multiplying gravitational sensations, when the machine approaches an unaccustomed inclination. The misinterpretation of these sensations has often resulted disastrously.

Bomb Dropping. In bomb-dropping it is quite needless for us to discuss the absolute necessity of having a gyroscopic horizontal reference plane of integrity and accuracy, or to enumerate the inaccuracies to which pendulums, mercury tubes, and other gravity devices are susceptible. Our experts have long ago exposed the total unreliability of all of these devices.

The gyroscopic apparatus is capable of staying within one quarter of one degree to the true horizontal. A sensitive aeroplane is held, through the intermediary of the servo motor and follow-up system, within three quarters of one degree of the position of this gyroscopic plane. This variation of three quarters of a degree might seem to the layman to be in effect a corresponding inaccuracy, but any one accustomed to reading a barograph, the index of which is designed to tremble or vibrate constantly, will appreciate the ease and accuracy with which the pilot bomb-dropper can secure his objective in the mean of two extreme positions, especially when close to each other. In this way more accurate results can be obtained than with non-oscillating conditions, be-

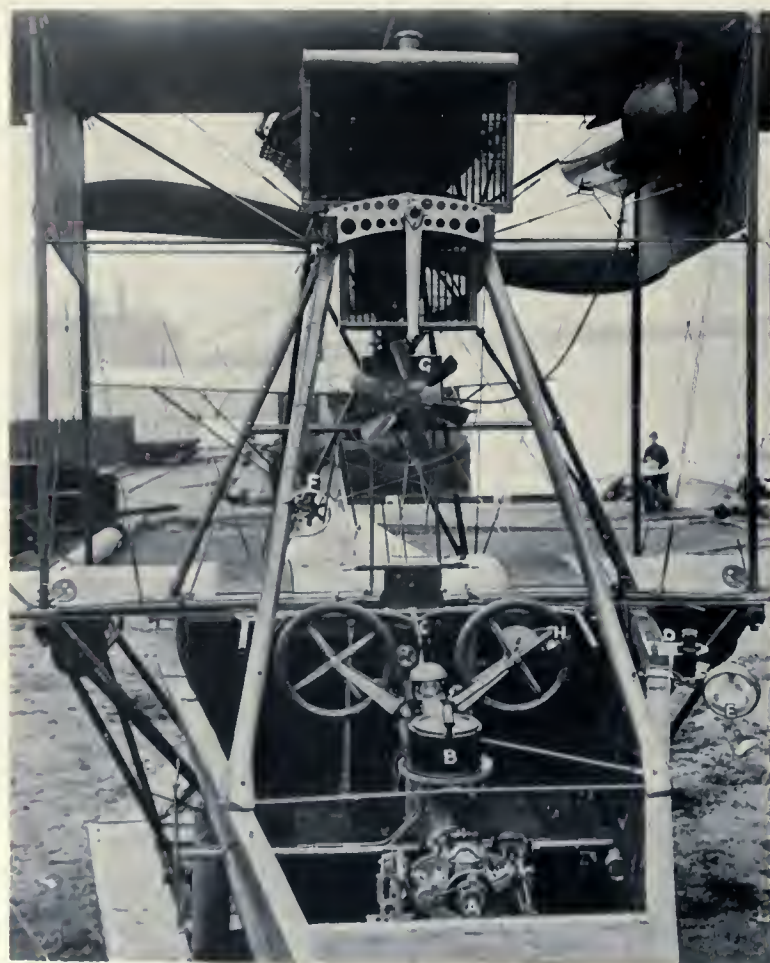

A—Gyroscopic Unit. C—Hand Control Lever. E—Search Light.
 B—Air Compass. D—Drift Indicator. F—Anemometer.
 G—Servo Motor. H—Hand Cut Out Switch

cause this motion makes all the parts of the follow-up mechanism extremely sensitive, as in the case of the baragraph. Furthermore, the slight motion assures the operator that the apparatus is functioning properly, while he need only consult his clinometer located on the gyro unit to check up accuracies.

The proposition to connect the bomb-sight directly to the gyroscopic element involves hampering its freedom by friction of the connecting links, and by the inertia vibrations of the sight; in addition, pressure of the hand in making adjustments is likely to cause inaccuracies. It is always advisable to leave the gyro as free and unmolested from outside forces as possible.

With the bomb-sight rigidly fixed to the side of the machine or to the floor, the method of sighting is somewhat as follows:

With the gyro manual control, the position of the aeroplane is adjusted until both clinometers read zero. The operator then secures by his rudder the motion of some objective in his field of vision, parallel to the longitudinal cross wire. During this time the deviation angle is set by taking the usual stop-watch readings, or other steps involving this very simple operation. The pilot bomb-dropper has now only to keep his ultimate objective moving along the longi-

tudinal wire before releasing the bomb when it reaches and crosses the lateral wire.

The increased accuracy of bomb-dropping from an aeroplane equipped with the Automatic Pilot is due to:

1. Being able to get the aeroplane more accurately laterally over the target.

2. Being able to release the bomb at the proper angular distance from the target.

3. Simplifying the operation of bomb-sighting, since the sight is held automatically and absolutely horizontal, thereby allowing the pilot bomb-dropper to focus his entire attention to adjusting the sight and steering the aeroplane.

During the long night bombardments, the elimination of the extra passenger has the advantage of either increasing the radius of action or of enlarging the bomb carrying capacity of the machine; while, of course, in the event of failure, one man is lost instead of two. The physical work of which the pilot is entirely relieved in long bombardment trips, especially with the larger types of aeroplanes, would frequently be too much for the ordinary pilot.

The important military functions for which the Sperry Automatic Pilot has been utilized demonstrate that it is essential to bringing the aeroplane to the highest point of military efficiency.

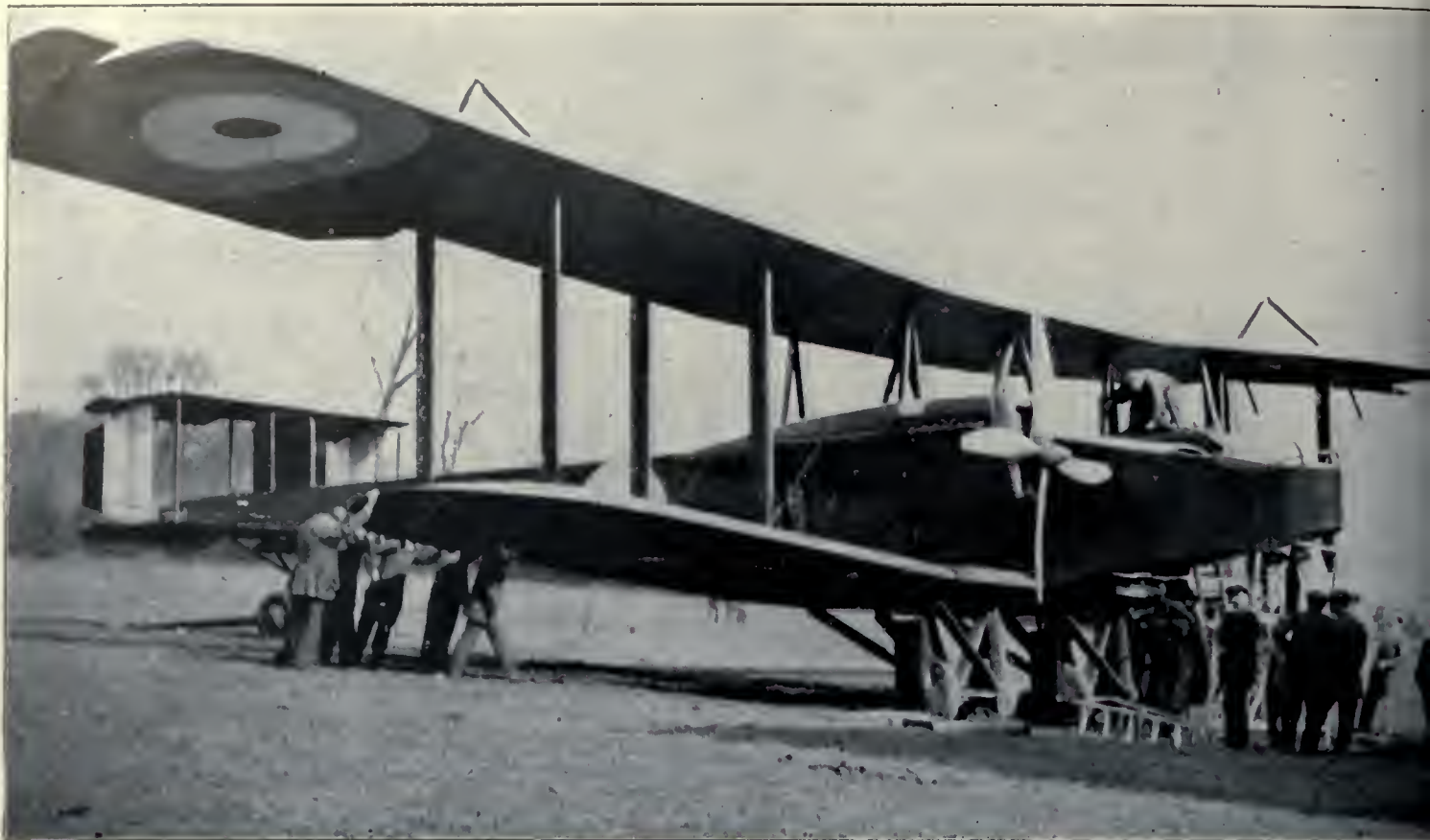

The Handley-Page Warplane which is equipped with two Rolls-Royce motors of 280 H.P. each and has mountings for four guns. It has wing span of 98 feet and is 65 feet long. It has carried 2 passengers in one flight.

CHAPTER XXII

THE CASE FOR THE LARGE AEROPLANE

BY F. HANDLEY PAGE, A.F.AE.S.

The question of aeroplane size is a most important one. It raises the whole question as to whether there is, or is not, a limitation to aeroplane size, and therefore whether progress in construction will be limited to improvement on present-day small types of machines, or whether there is an infinite possibility in the extension of designs to much larger types.

It has been argued by many that, just as ships, trains and other machines for transport purposes increase in size as years go on, so will the aeroplane progress, and that the larger aeroplane will have a definite place in the field of aviation. Others have adopted the opposite view.

The general consideration in favor of the large machine is that although there is a heavier initial capital outlay, large machines are much

cheaper to run than small ones, and thus progress is seen in every type of mechanical transport towards the employment of larger and larger machines with a view to taking full advantage of the economies effected.

In an aeroplane there could, however, be no advantage in the use of large machines if that increase in size gives a disproportionate increase in weight which would more than nullify constructional advantages, or if the large aeroplane had aerodynamical disadvantages. The whole case needs most careful examination from all points of view.

In the arguments set forth below I have endeavored to compare machines of different size and review their relative advantages, determining first of all bases of comparison to enable a true picture to be obtained. As these necessitate the explanation of a new method of

aerodynamical composition I have set this forth at rather greater length than is necessary for the development of the argument proper. After a discussion of the aerodynamical problem I have dealt with the effect on structural weight of an increase in the size of aeroplane, and then turned back to find the effect on the aeroplane's performance of the weight variation

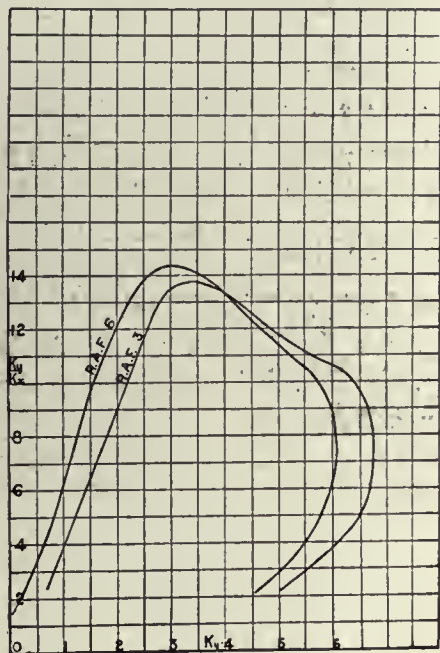

FIG 1

with size increase. Lastly, there are a few notes on the large machine from a flying standpoint. It is a matter of some difficulty to obtain a true basis of comparison from pilots' opinions. Pilots are, as General Braneker remarked in his paper, a very conservative body, opposed to innovation, and the machine of the moment's design is not necessarily the one of the future, or the one from which future machines will be developed.

Aerodynamical Bases of Comparison

To determine the calculated performance of any machine it is necessary to have available the wind-channel experiments on the Lift and Lift/Drag of a large number of planes as well as the resistance for various types of bodies similar to that proposed to be used. The curves of Lift and Lift/Drag are usually plotted in absolute units and in the form shown in Fig. 1.

From these wind-channel curves the performance of the whole machine is obtained.

After the general details of a machine's design are settled, such as the weight to be carried, the area of the planes, etc., the plane resistance at various speeds are found from the Lift and Lift-Drag curves. To these values are added the correct ones for body resistance, the values of the two curves added together and the total horsepower required calculated for different speeds. When the engine power and propeller efficiency is known, the curve of available horsepower can be plotted and the points of intersection of the two horsepower curves mark the limits of aeroplane speed variation.

It is quite easy to see that this method, although exceedingly useful for any particular aeroplane, does not afford a quick means of comparison between a machine with planes of different section or different shape or loading. I have therefore adopted a different method of plotting, so that the performance of any machine can be directly predicted from the wind-channel tests, on the Lift and Lift/Drag of the planes used, and on the body resistance, the new method taking into account the effect of altered loading or varying air densities at various heights.

I will deal first of all with the plane calculation.

The following is the notation adopted:

V —velocity of the aeroplane in ft./sec.

W—total weight in lbs. of the aeroplane.

A —area of main planes in sq. ft.

e —density of the air in lbs./cu. ft.

g —32.2.

K_y—absolute value of the Lift Coefficient.

K_x—absolute value of the Drift Coefficient.

R_b—total body resistance in absolute units per ft. per sec. of the aeroplane considered—i.e., resistance of the chassis, body, struts, in fact all the resistance of the aeroplane except that of the planes.

The following equations may be written:

$$W = K_y \cdot \frac{e}{g} \cdot A \cdot V^2 \dots \dots (1)$$

whence

$$V = \frac{1}{\sqrt{K_y}} \sqrt{\frac{W \cdot g}{A \cdot e}} \dots \dots (2)$$

or

$$V = a \cdot \frac{1}{\sqrt{Ky}} \dots (3)$$

where

$$a = \sqrt{\frac{W}{A} \cdot \frac{g}{e}} \dots (4)$$

$$\text{Resistance} = Kx \cdot \frac{e}{g} \cdot A \cdot V^2 \dots (5)$$

$$\text{H.P.} = Kx \cdot \frac{e}{g} \cdot \frac{A}{550} \cdot V^3 \dots (6)$$

Inserting the value of V from equation (2) above

$$\text{H.P.} = Kx \cdot \frac{e}{g} \cdot \frac{A}{550} \left(\frac{W}{A} \cdot \frac{g}{e} \right)^{\frac{3}{2}} \dots (7)$$

Whence

$$\text{H.P.} = \frac{Kx}{Ky} \sqrt{\frac{1}{Ky}} \cdot \frac{W}{550} \sqrt{\frac{W}{A} \cdot \frac{g}{e}} \dots (8)$$

or

$$\text{H.P.} = b \cdot \frac{Kx}{Ky} \sqrt{\frac{1}{Ky}} \dots (9)$$

Where

$$b = \frac{W}{550} \sqrt{\frac{W}{A} \cdot \frac{g}{e}} \dots (10)$$

Summarizing

$$V = a \sqrt{\frac{1}{Ky}} \dots (3)$$

$$\text{H.P.} = b \frac{Kx}{Ky} \sqrt{\frac{1}{Ky}} \dots (9)$$

Instead of the usual Kx and Ky curves for a plane there will now be plotted

$$\sqrt{\frac{1}{Ky}} \text{ and } \frac{Kx}{Ky} \sqrt{\frac{1}{Ky}}$$

which is equivalent to plotting h.p. required against velocities. A curve for the section known as R.A.F.6 and one for the section known as R.A.F.3 have been plotted out in this way. It is well to examine these curves to see their general application before proceeding to deal with the question of plane comparison. In Fig. 4 are plotted the ordinary Kx and Ky curves for R.A.F.6 and R.A.F.3. R.A.F.6 has the lower value of Ky maximum and higher value for Ky/Kx . The maximum value of Ky for R.A.F.6 is .605, and that of R.A.F.3 is .695. The result of this is reflected in the curves in Fig. 3 where R.A.F.3 gives a slower landing speed than R.A.F.6 for the same loading. The slow speeds are related in the ratio of the square root of their maximum Ky or in the ratio of 1 to 105. These plotted curves give them the relationship between h.p. and velocity for equal loading. If it is desired to know the actual speeds obtained with different h.p. or in effect to obtain the correct scale for these curves it is only necessary to obtain the multiplying factor, converting the horizontal scale into feet per second and the vertical scale into h.p. This is done by evaluating the constants a and b in equations 4 and 10 above, inserting therein the correct valuation of W , A and e/g .

Attention is drawn to the fact that the load-



The British Handley-Page gun and bombing plane. It has carried twenty-one passengers. (British Official.)

ing expressed in weight per unit of area, and the value of the density of the air expressed as weight per cubic unit of air, appear in the same form in both velocity and h.p. multiplying factors. It follows, therefore that these curves are

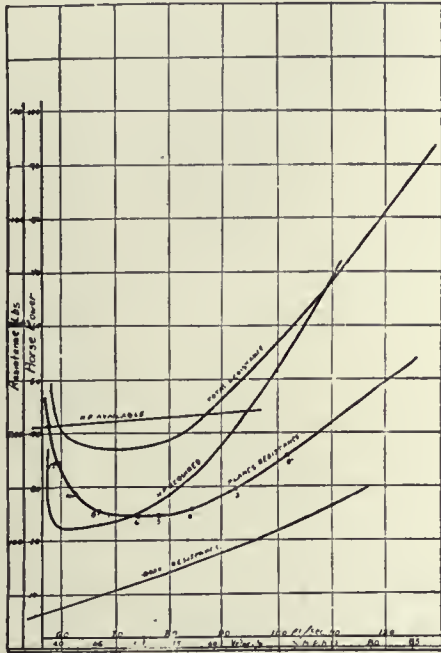

FIG 2

correct for any loading or height above ground level, the comparison between the two being correct as long as the loading is equal in both cases. The only alteration is the multiplying factor of the horizontal and the vertical scales.

It is hardly correct, however, to compare two machines, one of which has a slower landing speed than the other. For correct comparison the slow landing speed of a machine fitted with planes to R.A.F.3 section should be increased so that it is the same as that for R.A.F.6. The area of the R.A.F.3 planes should be decreased, thus increasing the loading until the two slow speeds are identical. The loading is increased in the ratio of 1 to 1.05. To compare the resulting curves it is better to keep the multiplying factors of the vertical and horizontal scales the same and alter the R.A.F.3 curve. Since the loading enters into the multiplying factor of the h.p. and velocity scales equally each value of the R.A.F.3 curve must be increased 1.05, both as regards h.p. and velocity. A new curve is now obtained for R.A.F.3 having the same slow speed as R.A.F.6 and the multiplying fac-

tors being the same for both. These new curves will again be true for all heights.

We will take an actual practical example. Assume a machine weighing 2200 lbs. with a loading of 5.9 lbs. per sq. ft., and that at the ground $p/g = 425$. Then from equation (4) $a = 50$ and from (5) $b = 200$. For R.A.F.3 the value of K_v (maximum) is .675, and of $1/\sqrt{K_v}$ is 1.215. For R.A.F.6 the value of K_v (maximum) is .605, and of $1/\sqrt{K_v}$ is 1.285. The slow landing speed of R.A.F.6 for the loading of 5.9 lbs. per sq. ft. is $50 \times 1.285 = 64$ ft. per second or 43.5 miles per hour. The slow landing speed of R.A.F.3 for the loading of 5.9 lbs. per sq. ft. is $50 \times 1.215 = 60.5$ feet per second or 41.2 miles per hour.

The new curve for R.A.F.3 will be for a slow landing speed of 43.5 m.p.h., and the loading will now be $\frac{43.5}{41.2} \times 5.9 = 6.25$ lbs. per sq. ft.

Each point on the old R.A.F.3 curve must have its vertical and horizontal value increased in this proportion—i.e., multiplied by 1.05. The new R.A.F.3 curve was plotted in this way.

The minimum height of either of these curves above the horizontal is the minimum h.p. required by the planes, and, neglecting body resistance, the curve with the minimum value will have the highest climbing speed. It must always be borne in mind that the curve with the higher loading will have the smaller planes, and therefore weigh less. Allowance must be made for this in effecting the comparison.

The three curves can now be compared. For the same loading and h.p. available R.A.F.3 has the slower landing speed, the higher climbing rate, but the slower top speed. If the loading be increased R.A.F.3 loses its advantage in climbing rate, and does not attain the same high speed as R.A.F.6. In a similar manner any other or more modern planes may be compared.

It is interesting to note, in passing, that at 10,000 ft. height where $p = 0.55$ the value of a will be increased to 59 and of b to 236. The effect of height is to reduce the h.p. required for any given speed, and also the speed range by increasing the slow speed. Owing to the h.p. scale being increased, the minimum h.p. required for flight is increased, and, therefore,

quite apart from reduced engine h.p., the excess h.p. available for climbing is reduced.

The general range of velocities for a high speed machine is from 50 to 130 m.p.h. or 73.5 to 190 ft. per sec. In general the value of $1/\sqrt{K_v}$ will lie between 1.4 and 3.8. For a slow speed machine flying from 40 to 90 m.p.h. or 59 to 132 ft. per sec. $1/\sqrt{K_v}$ will vary between 1.1 and 2.7. Any comparison between plane curves must be made between the velocity limits of the type of machine considered.

So far the comparison has only been extended to the planes of a machine. The body of resistance remains to be dealt with.

The equation may be written:

$$\text{Resistance} = Rb \cdot \frac{d}{g} \cdot V^2 \quad \dots \quad (11)$$

$$\text{H.P. required} = Rb \cdot \frac{p}{g} \cdot \frac{V^2}{550} \quad \dots \quad (12)$$

This equation is identical in form with the plane h.p. curve. The term Rb is the product of the values of a resistance coefficient K_{xb} and a body area S . The equation may therefore be written:—

$$\text{H.P. required} = K_{xb} \cdot \frac{p}{g} \cdot \frac{S}{550} V^2 \quad \dots \quad (13)$$

Whence inserting the value of V in equation (2) above

$$\text{H.P. required} = \frac{K_y}{K_{xb}} \sqrt{\frac{1}{K_y}} \cdot \frac{S}{A} \cdot \frac{W}{550} \sqrt{\frac{W}{A} \cdot \frac{g}{p}} \quad \dots \quad (14)$$

The H.P. required for body resistance can be plotted to the same scale as those for the planes. The values would be divided by

$$\frac{W}{550} \sqrt{\frac{W}{A} \cdot \frac{g}{p}}$$

There would then be plotted for the body resistance H.P. the value of:

$$\frac{K_y}{K_{xb}} \sqrt{\frac{1}{K_y}} \cdot \frac{S}{A} \quad \dots \quad (15)$$

The h.p. required for body resistance can now be added to the plane h.p. curves. Let us assume that the machine referred to in paragraph 10 above requires 10 h.p. to overcome body resistance at 100 ft. per sec. Below the horizontal line has been added a curve of h.p. required to overcome body resistance, the scale of h.p. being the same as that for the planes. The total height between the two curves for any value of $1/\sqrt{K_v}$ gives the total h.p. required at that speed. It is interesting to note that these curves



Partial view of the Caproni Triplane equipped with three motors of 200 h.p. This machine has a wing spread of 101 feet.

are correctly placed in respect of one another for all heights. This method of plotting and the curves so obtained give the necessary basis for a comparison between different machines, and reference will be made to them again later in the paper, after discussing the structural side of the question.

The Effect of an Increase in Size on the Structural Weight of Aeroplanes

Attention has already been drawn to the fact that an improvement in the aerodynamical qual-

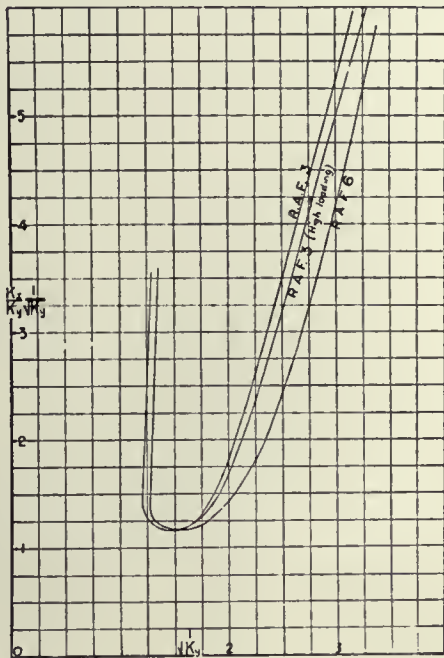

FIG. 3

ities of the machine as the size increases may be partially or completely nullified if the increase in size is accompanied by a disproportionate increase in weight. I will, therefore, accordingly examine the rate at which the weight increases with increase in size.

In this discussion we shall leave out the weight of the power unit comprising engine, tanks, and fuel, as well as the useful load, whether consisting of men or dead weight, such as guns, bombs, etc. We will confine our argument to the weight of the machine structure, that is, the portion which supports the load whether on the ground or in the air, with the necessary directing surfaces and their attachment to the main portion of the aeroplane. In the latter category come the planes, the fuse-

lage, and the chassis, and these will be considered seriatim.

In all discussions on weight saving there is the general question as to the best utilization of materials with the varying size of machines. As the machine is made smaller, so eventually a limit is reached beyond which it is not possible to decrease the minimum thickness of the material and retain adequate local strength. Especially is this the case in aeroplane work, where the members are usually stressed as struts, and for which, therefore, a hollow tubular construction is the most efficient form from the point of view of minimum strength for a given weight. In making tubular members, whether these be plane spars, fuselage, struts, or longerons, it is not advisable to decrease the thickness of the walls below $\frac{5}{16}$ in. to $\frac{1}{4}$ in. Even this is on the small side when allowance is made for errors in workmanship, and the fitting in of the necessary tongue piece to make a secure joint. Considerable economies can be effected in weight-saving with increase in size in this manner.

Local strength, too, determines the construction of subsidiary parts of the machine, such as the tail skid, the ribs, tail planes, a local strength that does not need to be increased with increase in size of the machine, and here, again, weight economy can be effected.

This better utilization of material more than offsets the increase in weight that would occur in the planes provided that they were increased in a geometrically similar manner and the loading aspect ratio and section kept the same. In a machine of which I can show you the photos later the plane weight per square foot is less than a small one for the same factor of safety, and the total plane weight is a lesser percentage of the gross weight.

The fuselage weight, owing to the better utilization of material, is considerably decreased. The chassis weight remains about the same.

The Effect of an Increase in Size Upon an Aeroplane's Performance

A general comparison can now be effected between aeroplanes of different sizes on the basis

of the curves described in Section II, the total weight of the aeroplanes considered being modified according to the size in accordance with the conclusions of Section III. An examination of equation No. 9 in which H.P. equals $b \times K_x/K_v \times \sqrt{1/K_v}$ shows that, provided that similar planes are used and that the weight per H.P. remains the same, the same plane curve represents all machines. These curves as plotted are, in fact, curves of H.P. required per pound weight of the machine for a given loading per square foot. Let us now examine the lower curve of H.P. required for body resistance and refer to equation 14. Provided that the area of the body increases in the same ratio as the plane area, this lower curve will still, for any size of machine, be correct in relation to the plane curve plotted above, and the summation of the two ordinates or the distance between the two curves will represent the total H.P. required, the scale being increased in proportion to the increase in ratio. The greatest resistance of an aeroplane is that of the body. This, for smaller shaped bodies, would increase as the square of its lineal dimensions, whereas its volume would increase as the cube. It follows, therefore, that the resistance of the fuselage per unit of volume will decrease with the increase in size of the aeroplane. The lower curve will have to be modified to meet these changed conditions. This decrease in weight will have the usual cumulative effect of decreasing the weight of all the rest of the machine.

The curves which are plotted are for H.P. per unit weight of the whole machine, and do not show so graphically the superiority of the large machine as if the curves of H.P. per unit of useful weight had been plotted instead of gross weight. In this case the curves for planes and body would have their vertical ordinance increased with the proportion of useful to total weight. The balance in favor of the large machine is thus apparent directly we compare machines of approximately the same total weight per H.P.

The conclusion that may be drawn from the above theoretical considerations of the aerodynamical and structural qualities of the large machine are that for the same total weight car-

ried per H.P. the big machine will effect the better performance.

The Large Machine from the Pilot's Standpoint

There has been very much less experience in the flying of large machines than with small ones, and, therefore, pilots are not so accustomed to their use, neither is the experience wide enough to draw general conclusions. It may, however, be safely said that large machines can be built to operate quite as easily and fly with as little fatigue as the best of the small ones. No Servo-motors are required for the controls, provided the controlling surfaces are properly balanced. There is less work in flying a large machine owing to the wind gusts, which seem large to a small machine, being relatively small in their effect on a large one. A large machine will plow its way through gusts without any control being necessary, whereas a good deal of warping might be necessary on a small machine.

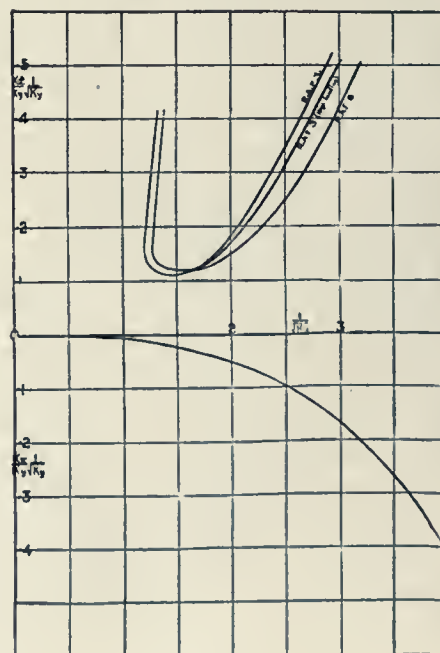

FIG. 4

The large machine can be handled more easily on the ground and can alight in smaller places.

When considered from the point of view of load to be carried or long distance to be flown the large machine has it all its own way. Where a large load is to be carried the size of the machine to do it must be increased until the



These men comprise the first group of American aviators who represented U. S. on the French front. In the group, left to right are: Lieutenant de Laage, Sergeant C. C. Johnson, New York City; Corporal Lawrence Rumsey, Buffalo, N. Y.; Sergeant J. R. McConnell, Carthage, N. C.; Lieutenant William Thaw, Pittsburgh; Sergeant R. Lufbery, New Haven, Conn.; Sergeant Kiffin Rockwell, Atlanta, Ga.; Adjutant Didier Masson, Los Angeles, Cal.; Sergeant Norman Prince, Boston, and Adjutant Bert Hall, Galveston, Tex. [Photo Courtesy N. Y. Times.]

useful load is sufficiently great. The size of the machine that is required for the purpose depends on the total weight per H.P. that can be carried. There is here no question of competition between large and small machines, it is a case of the correct machine for the purpose.

For future commercial developments the large machine scores with plenty of room for passengers to sit in comfort, or mails or luggage to be carried, and with its steadier movement will afford great comfort to those who travel by it. It is probable that commercial aeroplane work will be undertaken for long-distance journeys. Where delays at the commencement of the journey are a large percentage in time of that necessary to complete the distance, the possible time taken to traverse a given space may be as great or even greater than that taken by a more certain means of transit. It is the old question of the hare and the tortoise. Where, however, the distance to be traversed is great, such as 1,000 to 2,000 miles, or with journeys such as crossing the Atlantic, the passengers or mails could afford to wait a day or two and will accomplish the journey far quicker than any other means of transit. Were the commercial development of aviation

confined to journeys of from 50 to 200 miles, delays at starting or the cost of organizing to prevent them would cause the aeroplane's use to be considerably nullified.

It is this question of certainty in operation that requires careful attention, for it is the one thing at the present time that the aeroplane requires in order that it may take its proper place in commercial work. Engines for this will probably be more heavily built to reduce the possibility of breakdown, and multi-engine machines will be used which can fly satisfactorily even if one engine breaks down. Here again this points to the use of the larger machine.

Finally, it must be pointed out that the same improved performance can be obtained from a large machine, whether for scouting, fighting, or weight carrying, provided that the specifications are the same in both cases. It is absurd to compare the performance of a weight-carrying machine with high values of useful weight per H.P. with a small scout of very small useful weight per H.P., and particular attention is, therefore, drawn to the methods of comparison set out in Section II, so that careful comparison may result.

Memoranda:

CHAPTER XXIII

EVERY MILITARY AVIATOR OUGHT TO KNOW WHAT HIS OWN AND THE ENEMY'S MACHINE CAN DO AND HOW THEY LOOK

(Courtesy of *Aërial Age Weekly*)

"If you see an aeroplane that does not look like any of the machines shown in this leaflet, you are to make every effort to bring it down."

This, in effect, is the instruction that every French and Italian aviator receives, not only while he is being instructed, but periodically, whether he is at one of the permanent military aerodromes or temporarily stationed on the front.

The Allied Governments found it necessary to teach their aviators and students all about their own machines and as much as possible about the enemy's machines, particularly their appearance. As a basic principle, the aviator is taught that what does not look like one of the Allied machines must be an enemy machine. Therefore every effort should be made to bring it down.

The anti-aircraft forces are taught the same thing, and knowledge of the features of the different types of aeroplanes is one of the prime factors in making anti-aircraft forces efficient.

Lacking that knowledge, the Allied air forces, as well as the anti-aircraft defenses, get confused and permit the enemy to obtain temporary advantages which cost the lives of Allied aviators, as well as of the population of cities which are raided, without mentioning the strategic advantages that the enemy gains through gathering information or surprising the Allies.

It has also been found of extreme importance to have every aviator know what the enemy's machines, as well as his own machines, can do. It will be recalled that when the first "Spad" appeared, the German aviators did not give it credit for the speed it had, so they ventured too much and too far for their own good. The Cigogne Squadron and the Lafayette Squadron were enabled thereby to maintain supremacy in

the air and to bring down a number of German aviators who did not know the fighting characteristics of the "Spad."

In several cases some of the machines which were thought to have "blind sides" were found to have guns mounted at front and rear, and to shoot below as well. An aviator in a single-seater fighter would attack what appeared to be a "pusher type," and all at once a gunner would emerge from the small cockpit and turn a stream of fire on him.

The United States is to train thousands of aviators, observers, aerial photographers, and anti-aircraft gunners. Many are taking their preliminary course, and thousands are waiting their turn. Thousands more of prospective candidates are not yet of age, or have passed the draft age and will volunteer as they learn more about military aeronautics. Military and aeronautic authorities agree that a valuable service can be rendered to the nation by continuing to publish descriptions of machines used by the enemy, as well as by the Allies. In the last case it is necessary, of course, not to publish details of machines which the enemy has not yet captured, or to give details of performances of newly adopted types. In a general way, any type that has not been used in number at the front for a period of at least two months must be considered as new, and details of performances must not be published.

The publication of details of German machines is encouraged. The Boche knows, of course, all about his own types; he also knows how the Allied aeroplanes look, as soon as one or two are captured. But he does not always know all about performances. Therefore, information about performances of new types should be withheld.

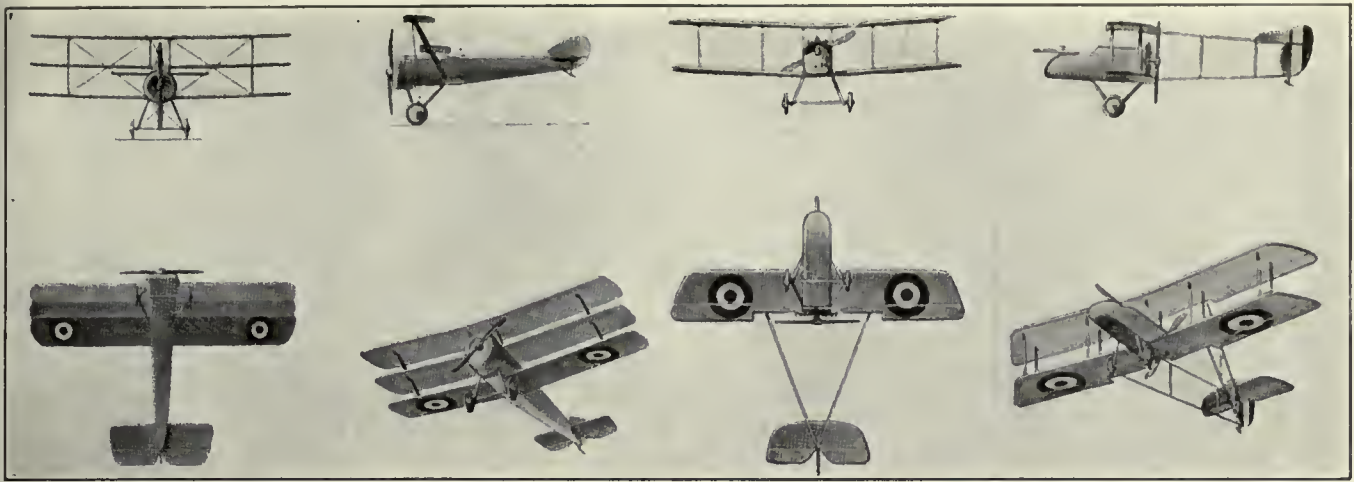

Sopwith Triplane (British). The motor, a rotary Clerget, is completely surrounded by an aluminum cowling. The planes are equal in span, very narrow in chord, and braced by a single strut at either side of the fuselage. Planes highly staggered.

De Havilland 2 (British). Somewhat resembles the F. E. 8, but the outriggers meet one another at the vertical rudder instead of at the tail plane.

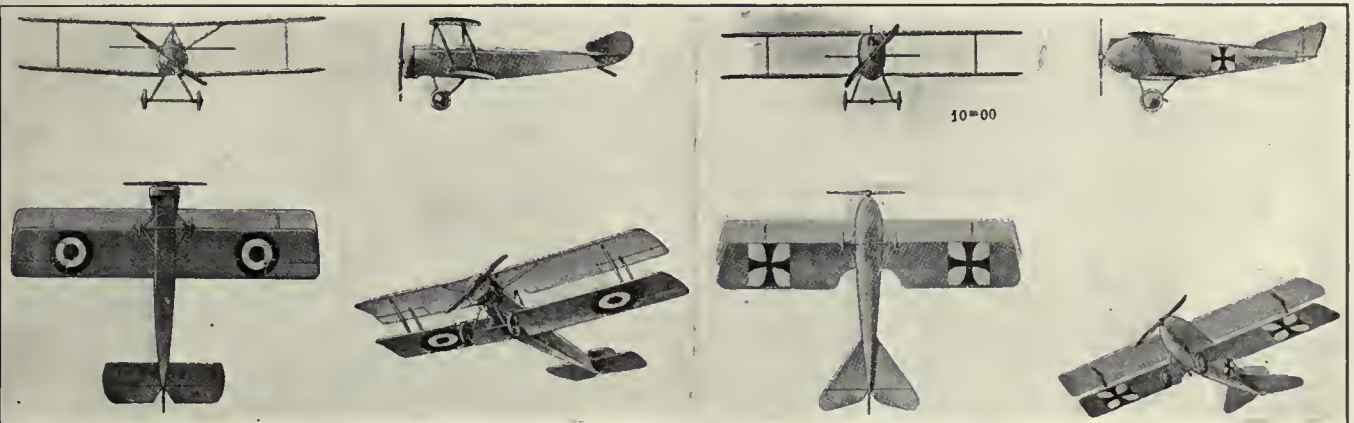

Sopwith single-seater (British). Used by the French and British. Also the Sopwith two-seater. Equipped with a rotary engine, Clerget or Rhone. Identified by the central set of struts, which stagger outward at the upper end. The fixed triangular fin is rounded off at its leading end. Planes are considerably staggered. Ailerons on both upper and lower planes.

Roland two-seater (German). The engine is a fixed Mercedes, 175 h.p. A machine-gun and bombs are carried. The body is exceptionally deep, reaching as high as the upper plane. Windows are provided in the sides of the fuselage for observation. There is but a single interplane strut at either side of the body. Planes are considerably staggered. Fin and rudder placed very high.

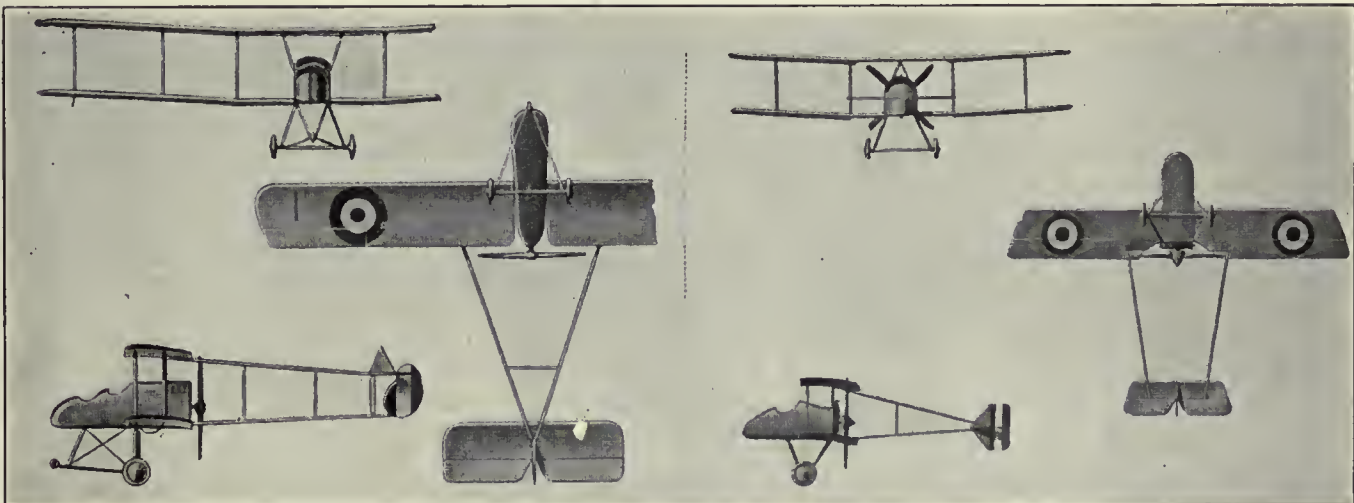

F. E. 2b and 2d (British) (Farman Experimental). Pusher type with a nacelle which carries a fixed Beardmore or Rolls-Royce engine. Empennage carried on four outriggers. Landing gear consists of two main wheels and two smaller auxiliary wheels below the forward cock.

F. E. 8 (British). Scout type single-seater pusher with a rotary Monosopape-Gnome engine. Fin and rudder area similarly disposed above and below the tail-plane. Two-wheel landing-gear and tail-skid below the fin. A movable Lewis machine-gun is carried on the deck of the nacelle.

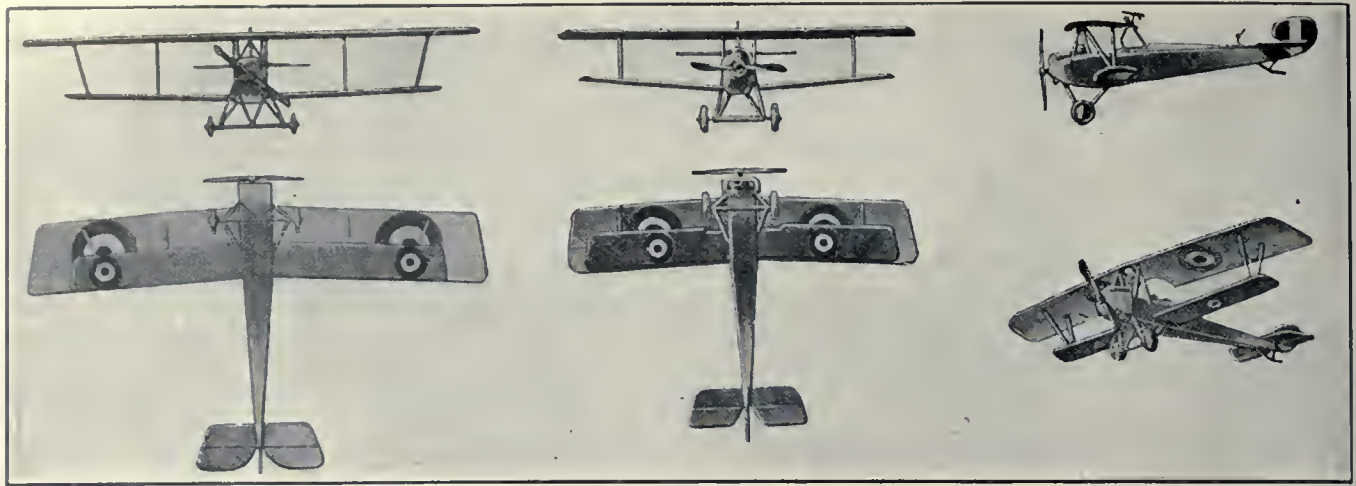

Nieuport. Used by the French, British, Belgians, and Italians. Made in single-seater scouts which have rotary Rhone or Clerget engines and having a small wing span, and also two-seaters with fixed Hispano-Suiza engines and a larger wing span. Struts between the planes are V shaped. Two seaters have two sets of struts at either side, the outer sets inclined outward at the top. Other struts are vertical.



Bréguet Av. (French). Has a fixed Renault engine. Dihedral on the upper plane only. There are ailerons on the upper and lower planes, the lower ones being exceptionally long and extending from the wing-tip nearly to the body. The elevators are balanced.

Bristol Scout (British). Called the "bullet." One of the fastest scouts. Uses a rotary Rhone engine. There is also a Bristol two-seater which has two pairs of struts at either side of the body. The two-seater is equipped with a fixed engine.

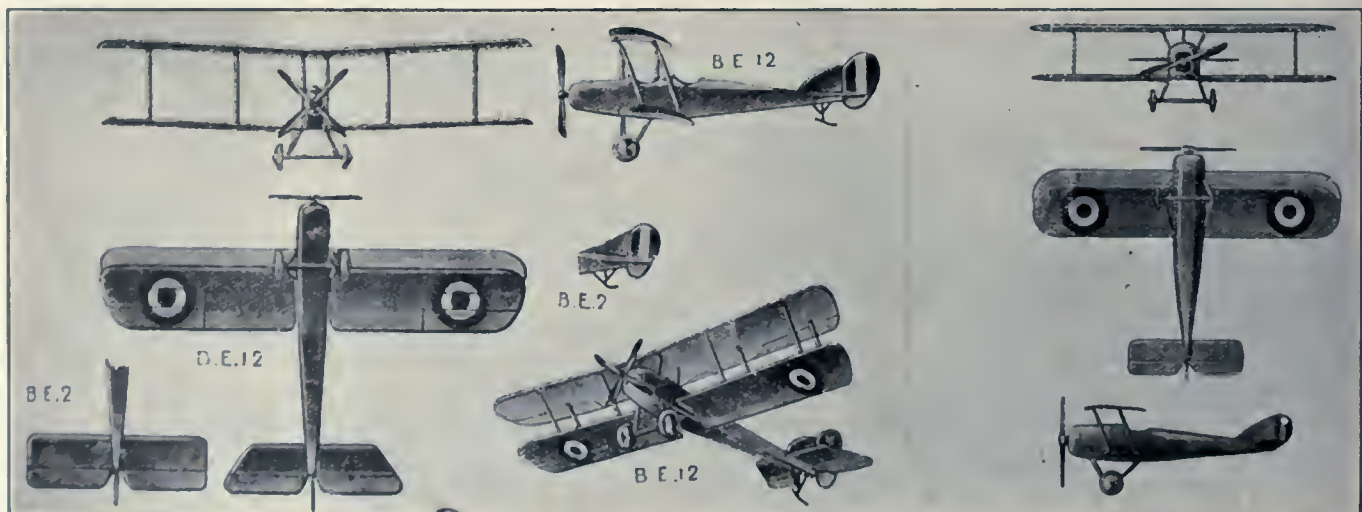

B. E. 2c and the B. E. 12 (British) (Bleriot Experimental). These machines are equipped with fixed R. A. F. (Royal Aircraft Factory) engines with a four-bladed propeller. The planes are staggered and have a pronounced dihedral on both planes.

Vickers Scout (British). Rotary Clerget engine. Single pair of struts at either side of the body. Planes equal in area and similar in outline. High stagger. The engine is completely surrounded by an aluminum cowling.

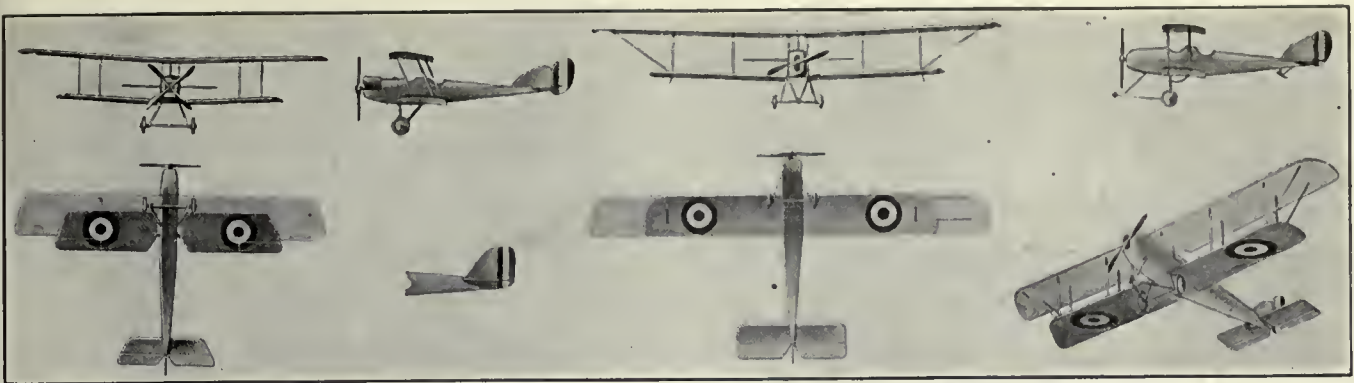

B. E. 2e and R. E. 8 (British). There is a single pair of struts at either side of the body, in addition to one strut which connects each pair of ailerons on upper and lower wings.

R. E. 7 (Reconnaissance Experimental) (British). Upper plane of greater span than the lower. Two pairs of vertical struts at either side of the body and a pair of inclined struts which carry the overhang.

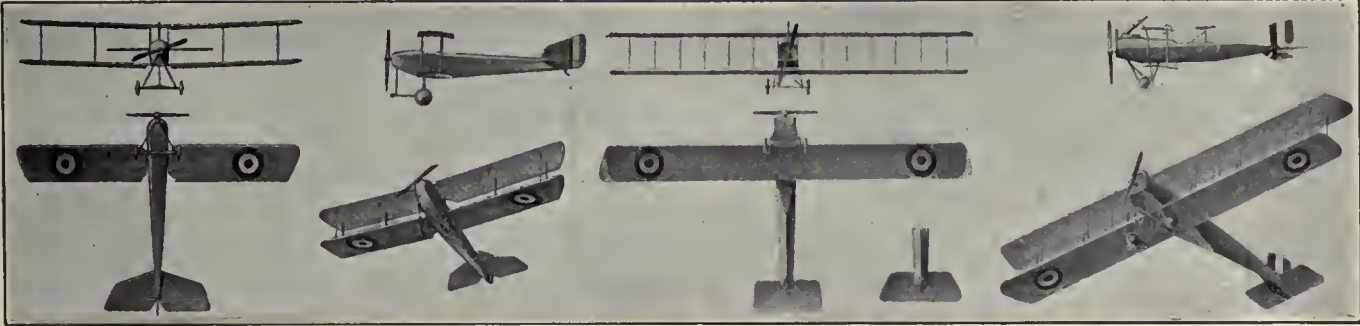

Armstrong-Witworth (British). Upper and lower planes are practically similar in shape. They are not staggered nor swept back, and have but a little dihedral. Two sets of struts at either side of the fuselage. The fin surface is rather large and carries the rudder quite high.

Paul Schmitt (French). Made in two types; the type B. R. A. H. (Bombardment Renault, Ailes hautes) and the B. R. A. B. (Ailes bassés). The planes of this machine are arranged to be altered while the machine is in flight, changing the angle of incidence according to the lift required.

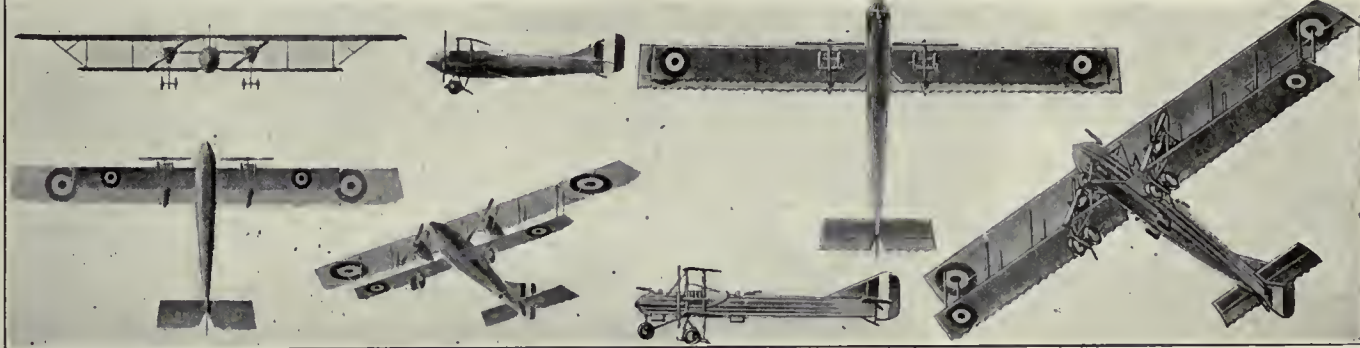

Caudron G. 6 (French). Quite similar to the R. 4, but two rotary engines are used. It has only four landing wheels and a very narrow lower plane. The upper plane overhangs considerably and is braced by sloping outer struts. Trailing edge very flexible.

Caudron R. 4. Used by the French and British. Twin-motored tractor type with a fuselage. The landing gear is composed of a pair of wheels below each motor compartment and a fifth wheel at the nose of the fuselage.

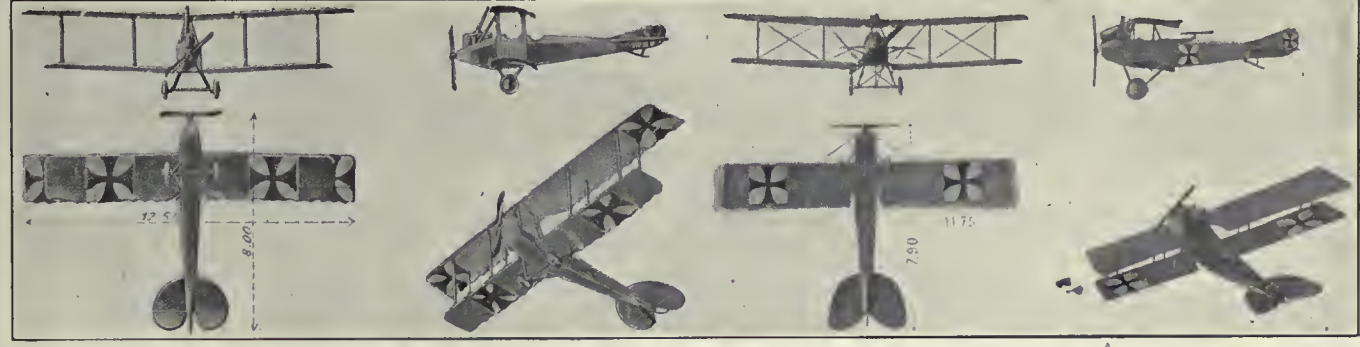

Aviatik (Aviatik-u. Automobil-Gesellschaft) (German). A fixed Mercédès 175 h.p. engine is installed. The familiar exhaust stock carries the gases from the engine and leads them over the top plane.

Albatros C.III. A German "all purposes" machine which carries a fixed and movable gun. Radiator carried in the upper plane. Exhaust pipes similar to that of the Aviatik.

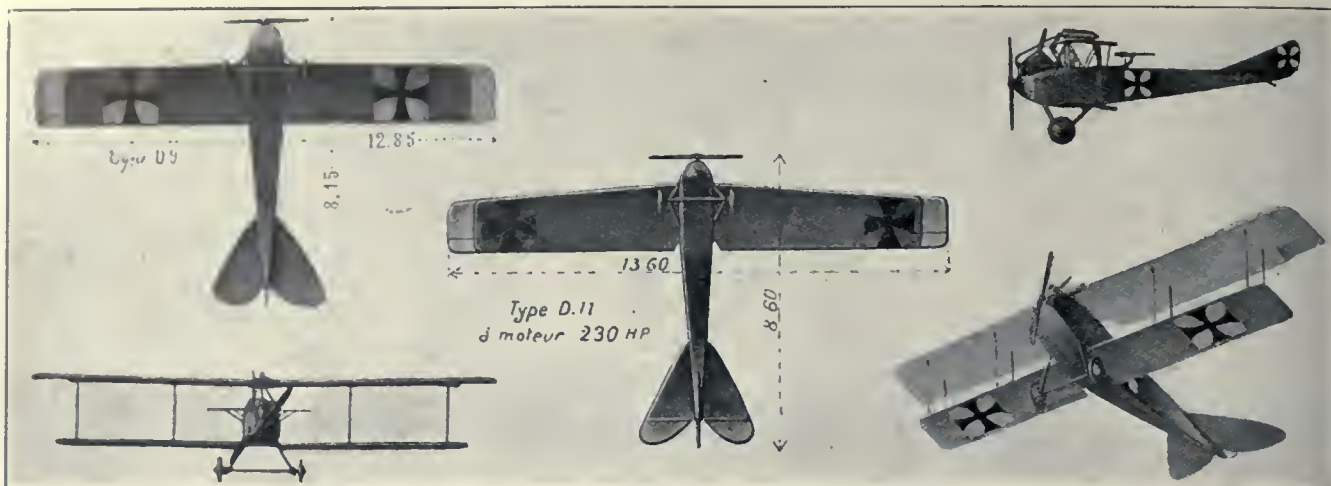

L. V. G. (Luft-Verkehrs-Gesellschaft) (German). Made in two types: Type "D9" which has a 175 h.p. Mercedes or Benz engine, and Type "D11," having a 235 h.p. engine. Distinguishable by its "half-negative" ailerons and the long span of the D11, the wing-chord of which is greater near the body than at the wing-tips.

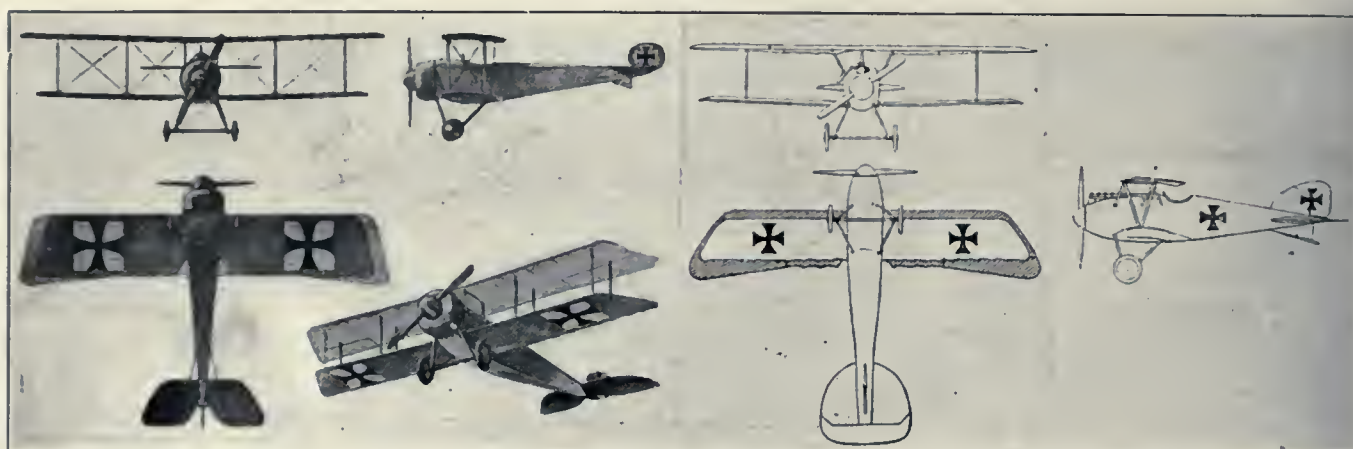

AGO (Aktien Gesellschaft Otto). A German single-seater. Rotary Oberursel engine with propeller spinner or nose-piece. The vertical rudder is balanced much in the manner of the French Nieuport. The upper plane is but slightly greater in span than the lower and both planes have practically the same chord, whereas the Nieuport has a narrow lower plane.

Albatros D.III (German). Single-seater scout equipped with a vertical Mercedes engine. Very apt to be mistaken for a Nieuport, as it has V struts and a narrow lower plane. It has, however, a high vertical fin and an under-fin tail-skid.

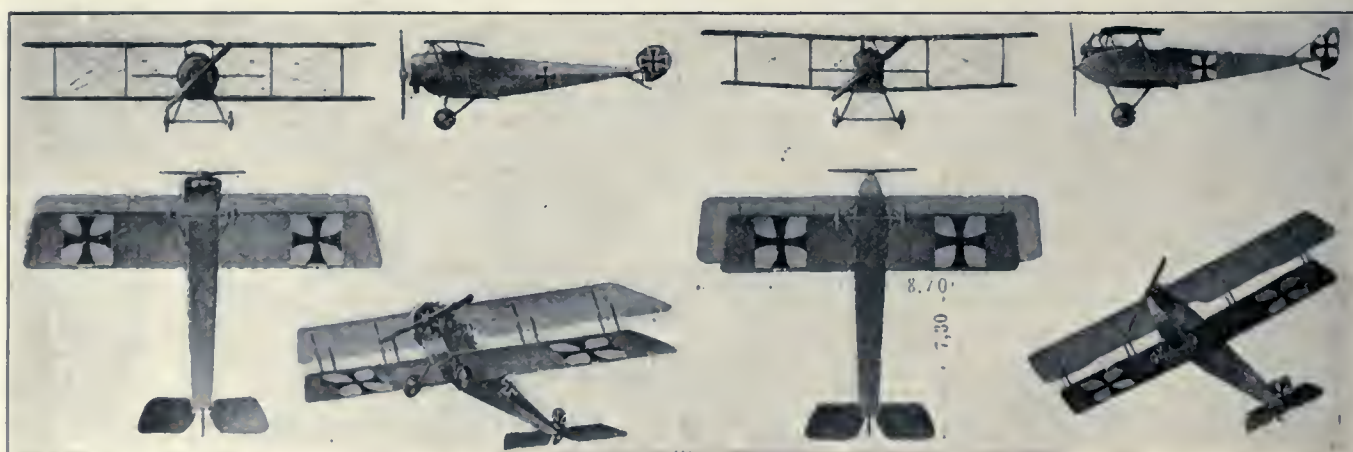

Fokker (German). Single-seater scout machine, with a rotary Oberursel 100 h.p. or a fixed Mercedes 170 h.p. engine. This machine is very similar to the Morane-Saulnier, but is distinguishable by its comma-shaped balanced directional rudder and its two pairs of interplane struts. Evidently its constructors appreciate the value of adhering to Morane-Saulnier lines.

Halberstadt (German). Single-seater equipped with a fixed Argus or Mercedes engine. The planes are staggered 1'6", and the upper plane slightly overhanging, thereby differing from the Morane. Over-all length, 24'0". Span, upper plane, 28'6"; lower plane, 25'10". Chord, both planes, 5'2". Gap, 4'4". The balanced tail-flaps measure 10' from tip to tip, and are 2'4" wide.

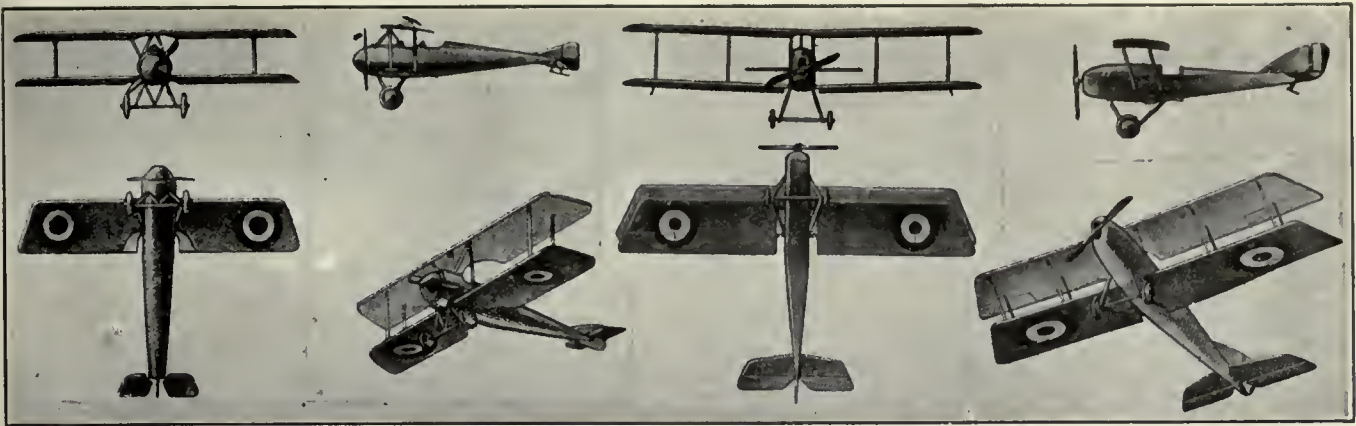

Morane-Saulnier. Employed by the British. A rotary engine is used, preceded by a streamline noseplate. The undercarriage structure resembles the letter M (initial of "Morate").

Martinside (British). Engine is fixed. Ailerons on upper and lower planes which are about equal in span. The tail-plane is narrow in comparison with its span.

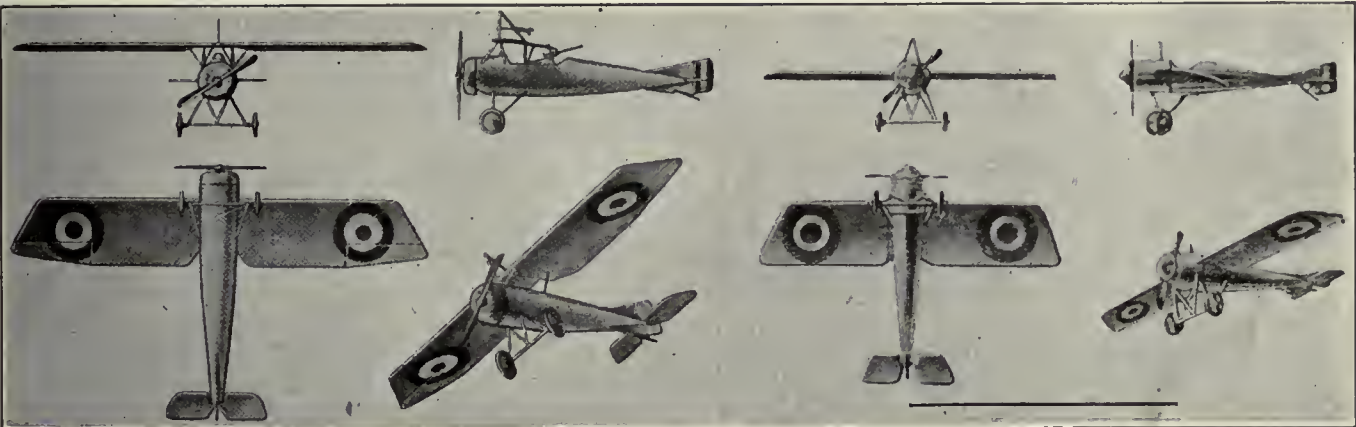

Morane-Saulnier monoplane (used by French and British). The Parasol type is equipped with a rotary engine and resembles the Morane-Saulnier biplane.

Morane-Saulnier monocoques 11 and 13 mq. It is often mistaken for a German Fokker, which is a copy of the earlier Morane-Saulnier.

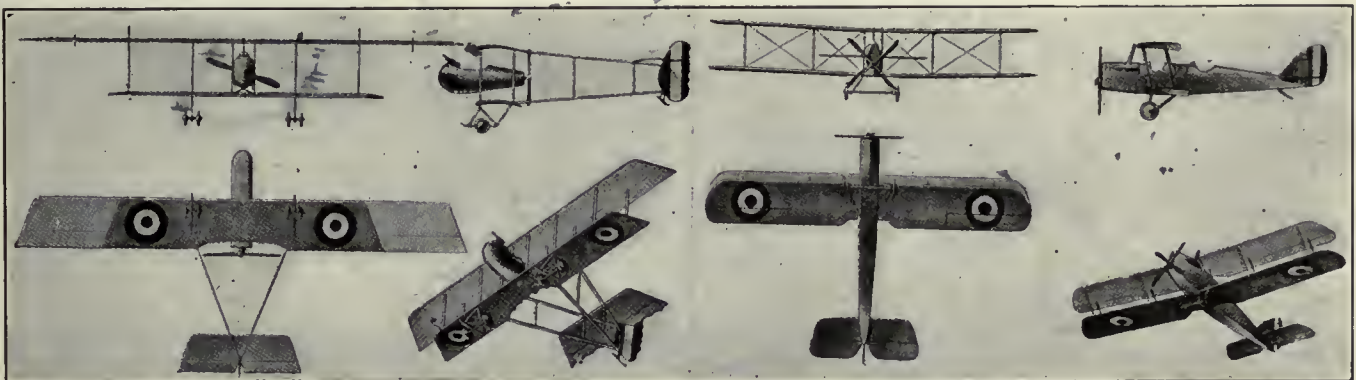

Farman Frères F. 40 (French). A pusher type biplane with a fixed engine. The nacelle is situated above the lower plane. Lower plane has the same chord, but about one third less area than the upper. Ailerons on the upper plane only.

De Havilland 4 (British). Uses a V-type engine and four-bladed propeller. Planes are slightly staggered, but not swept back and very slight dihedral. Two pairs of struts used at either side of the fuselage. A balanced type rudder used.

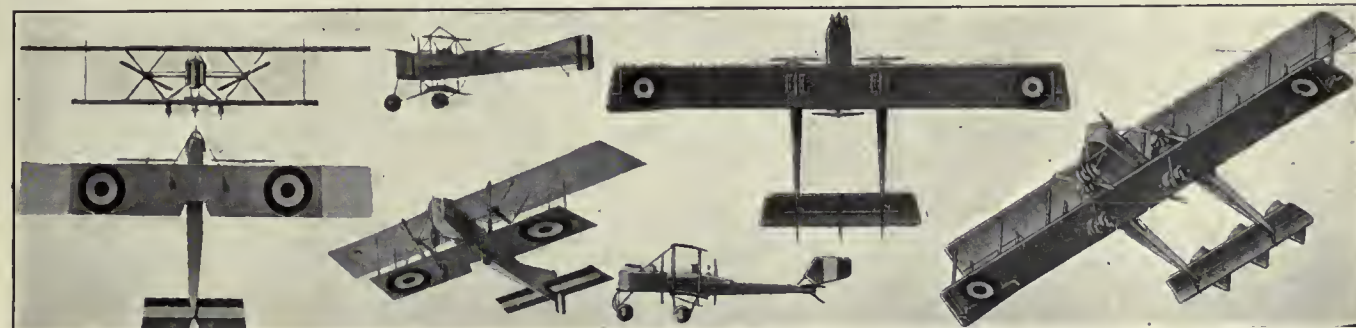

Salmson-Moineau (French). A tractor biplane with twin propellers driven by a single Salmson engine. The propellers are carried between the planes by means of X-shaped struts. The empennage surfaces are rectangular in shape.

Caproni R. E. P. (Italian and French). This is a 3-motored biplane with two motors in tractor position, located at the front of the fuselages, and a pusher engine at the rear of the central nacelle.

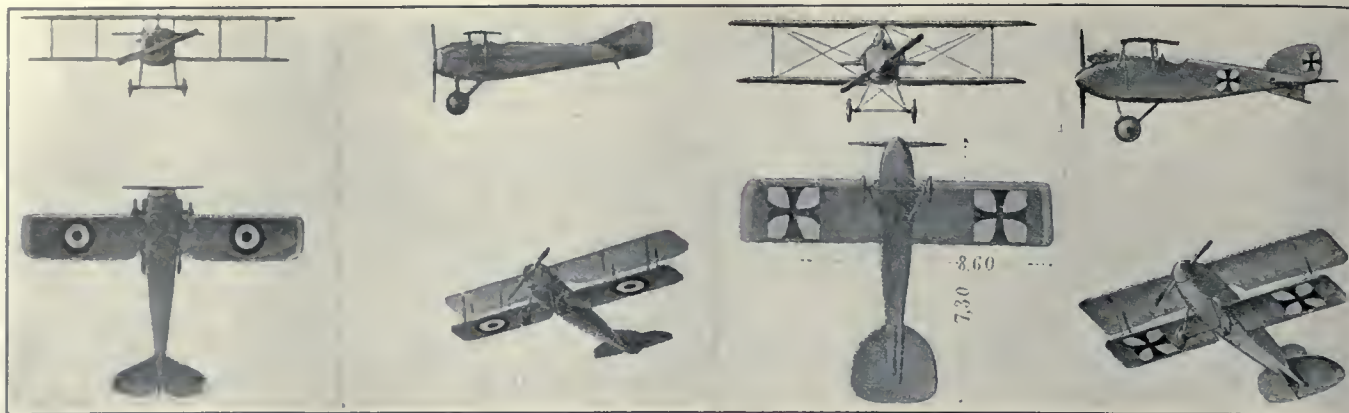

Spad single-seater scout (Société pour l'Aviation et ses Dérivés). Used by the French and British. All Spads are equipped with either 150 or 200 h.p. engines. This machine is easily confused with the Albatros, a German scout.

Albatros D. I. Single-seater scout. (German.) One of the fastest of German aeroplanes. It is equipped with a 170 h.p. Mercedes engine or a 25 h.p. Benz and provided with two fixed machine-guns arranged to fire through the propeller.

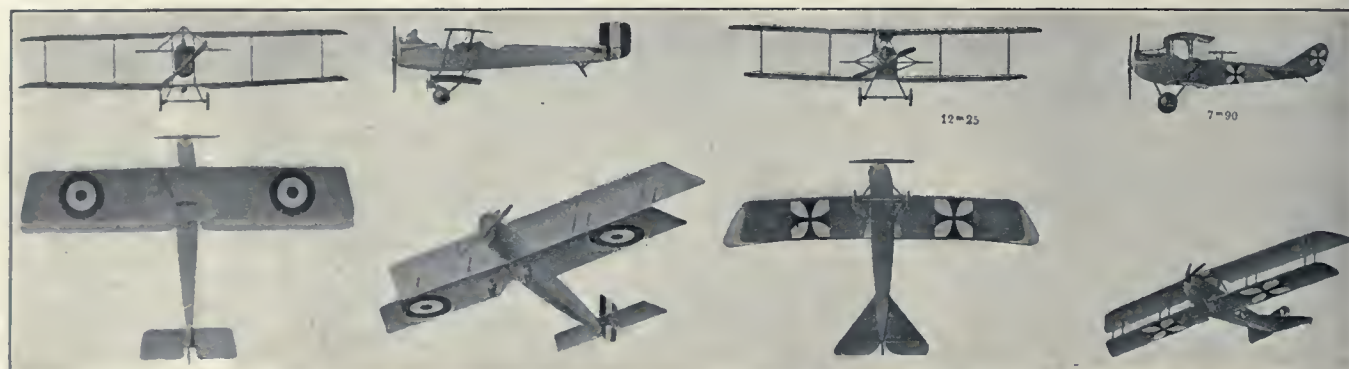

A.R. or A.L.D. French machine for all uses. Planes are invertly staggered and the fuselage is set above the lower plane.

Rumpler. (German.) Has the Mercedes 175 h.p. engine, a fixed and a movable gun. Radiator semi-circular, set into the upper plane.

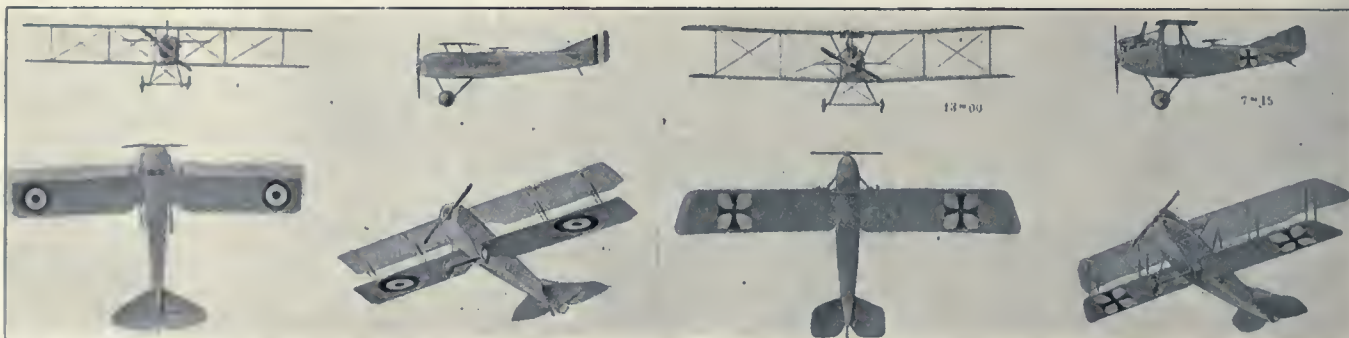

Spad two-seater. (French.) Fixed engine. Similar in outline (and construction) to the Spad scout. The two-seater carries a movable gun at the rear, in addition to a fixed machine-gun synchronized with the propeller and firing directly ahead.

A. E. G. (Allgemeine Elektrizitäts Gesellschaft.) A German two-seater with a 175 h.p. Mercedes engine. It carries a gun synchronized with the propeller and one movable at the rear.



Letord. (French.) A three-plane twin-motored biplane tractor using fixed engines. The planes are staggered backward and the struts are run vertically backward at the tops.

Morane-Saulnier twin-motored. (French.) This is a three-plane tractor with nacelles carrying either rotary or fixed engines. Two machine-guns are used.

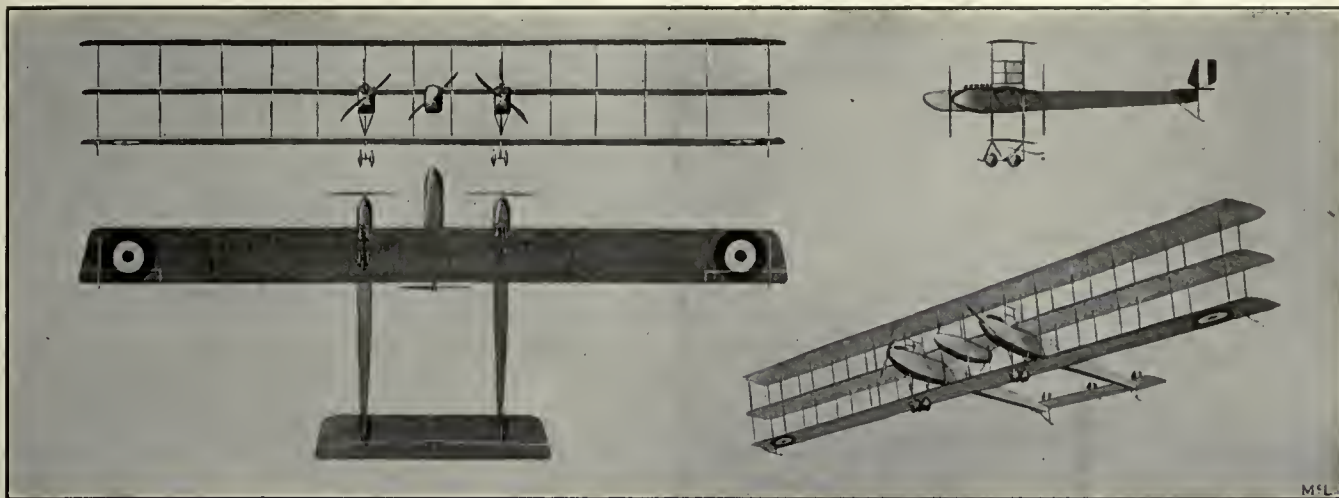

Caproni Triplane (Italian). Italy's best known aeroplane, and the largest triplane built. It is equipped with three Fiat or I. F. engines; two located in tractor position at the front end of each fuselage, and one pusher at the rear of the pilot's nacelle.

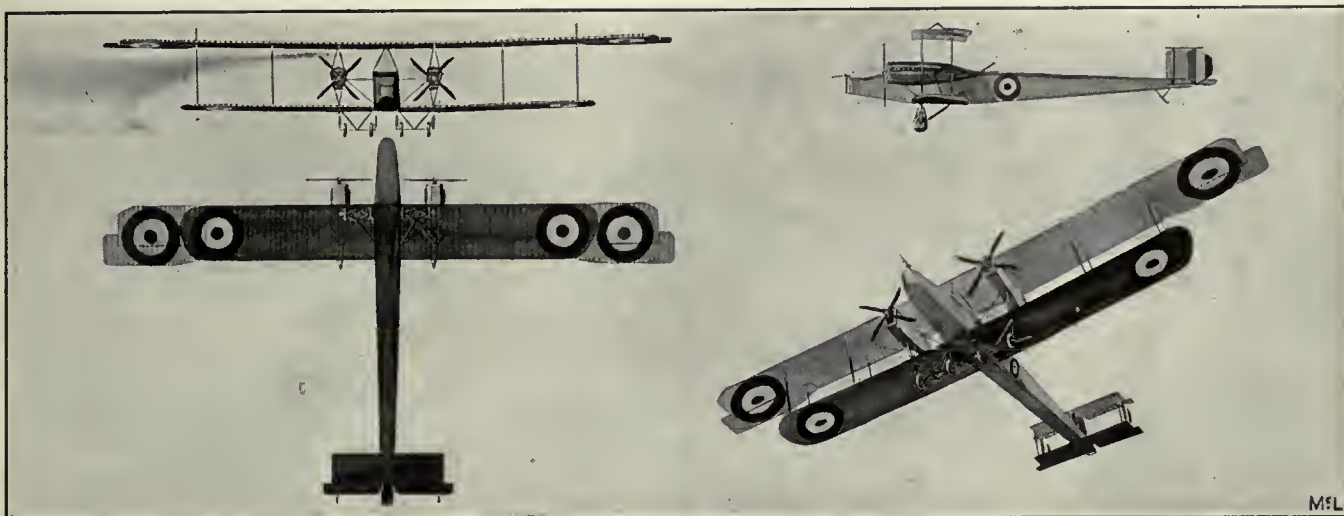

Handley-Page (British) Twin-engine bombing biplane. One of the largest machines built. It is equipped with two 12 cylinder Rolls-Royce engines. It holds all world's records for large aeroplanes carrying from one (1) to twenty-one (21) passengers. Its wing-span is 98 feet. It is identified by its biplane tail, the motor nacelles mounted between the planes, the large overhang of the upper plane and the balanced ailerons. The undercarriage is composed of four shock-absorbing wheels and a small tail-skid.

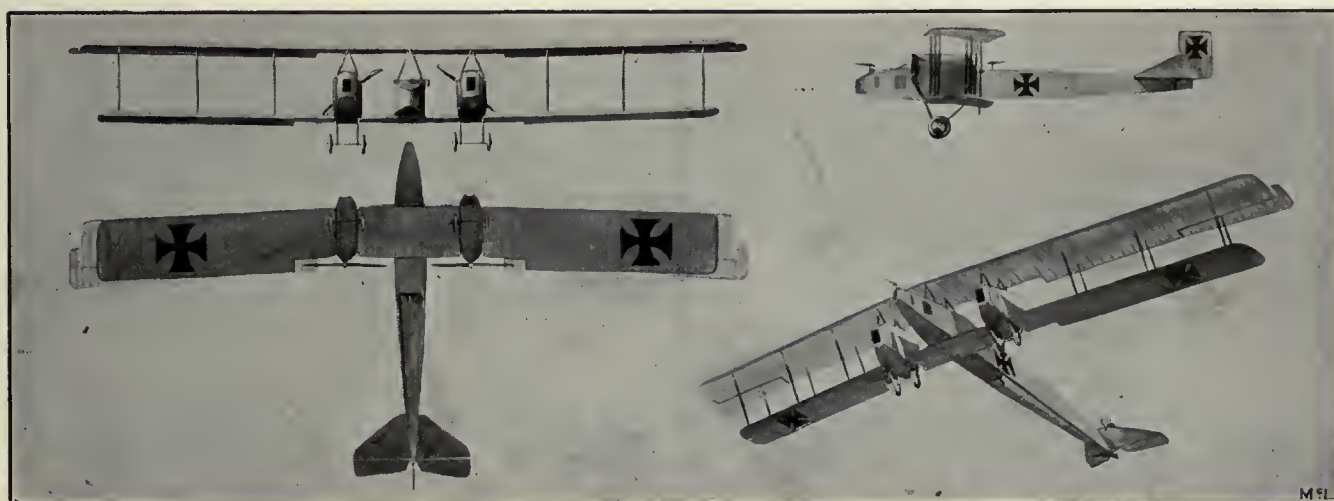

Gotha (German) twin-engine warplane. The machine used in a considerable number of raids on London and recently on Paris. Has a span of 78 feet and carries two Benz engines totalling to 450 in h.p. The machine bears a resemblance to the British Handley-Page, from which data for constructing the Gotha was obtained, but it is a pusher and the Handley-Page is a tractor. Identified by its overhanging balanced ailerons (similar to the Handley-Page) and its usual monoplane tail (differing from the British machine which has a biplane tail). Three machine guns are carried; one in the front, one at the rear cockpit and a third below it, which can be fired downward and backward through a so-called "gun-tunnel" on the underside of the fuselage.

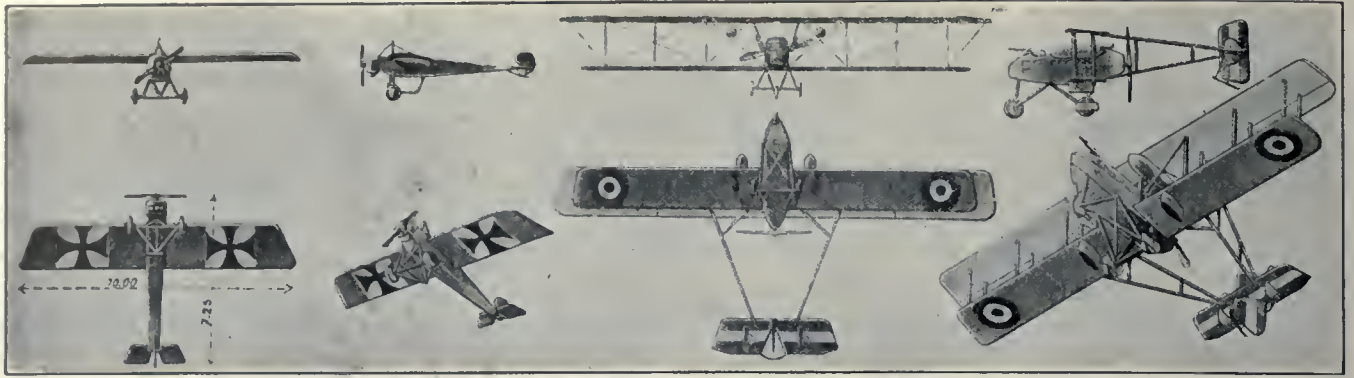

Fokker monoplane (German). Follows closely the French Morane, especially as to its balanced elevators. Equipped with a rotary Oberursel 80 or 100 h.p. engine. One of the first German machines to successfully employ a mechanically operated machine-gun firing through the sweep of the propeller.

Bréguet (French). Bombing machine of the pusher type. Carries a light cannon or machine-gun. Landing gear has three wheels. Two vertical fins and a vertical rudder.

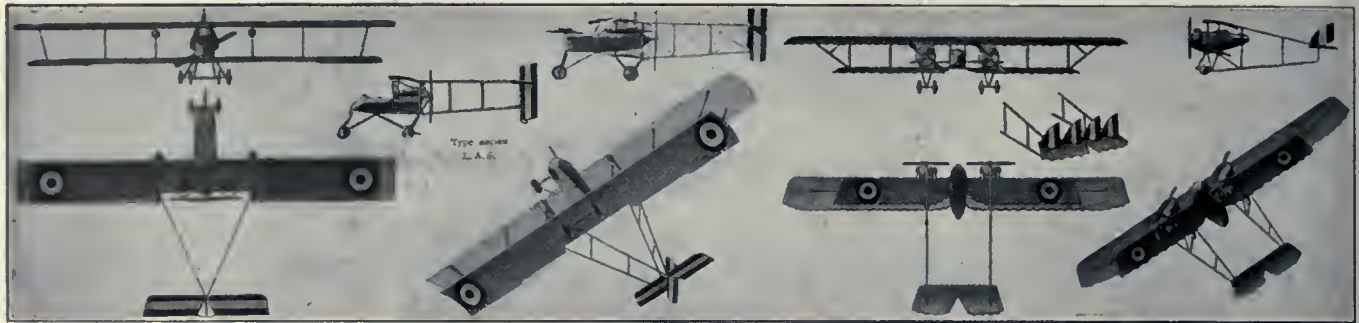

Voisin (used by the French, British, Belgians, and Italians). The engine is a fixed type. This is a pusher type bombing machine, with a balanced rudder and a balanced elevator carried on four outriggers which terminate in a vertical chisel edge.

Caudron G. 4. (Used by French, British, and Italians.) Two rotary engines are carried in small nacelles between the planes. The pilot's nacelle is situated between the motor nacelles. The empennage is carried on four outriggers running back in line with the engines, the lower outriggers acting as landing skids. Four vertical fins and four rudders are located above the tail.



Avro (A. V. Roe & Co., Ltd.) (British). The Avro machines have an equal upper and lower wing-span. In the twin motored machine the engines are carried on the lower plane, with exhaust stacks running up over the upper plane. Vertical engines are used. A wheel is located beneath each of the two engines. The two-seater Avro has highly staggered wings and a slight dihedral. The landing gear is characteristic; the long central skid is located between the wheels, supporting V struts at either end. The rudder is of the balanced "comma" type. There is no vertical fin. A rotary engine is used.

AMERICAN AEROPLANES, 1917-18



CURTISS "TWIN JN"



CONTINENTAL PUSHER



WRIGHT-MARTIN "R"



UNITED EASTERN



THOMAS-MORSE



L.W.F. TRACTOR



AEROMARINE



CURTISS TRIPLANE



ORDNANCE ENGINEERING



STURTEVANT



WITTEMANN - LEWIS



CURTISS "JN4-B"

McLaughlin

AMERICAN AEROPLANES, 1917-18



BERCKMANS SCOUT

WRIGHT-MARTIN "V"



STANDARD "J-R" PURSUIT



PIERCE SPORT TRACTOR



THOMAS-MORSE SCOUT



LAWSON "MT-1"



BURGESS "B.P." TRACTOR

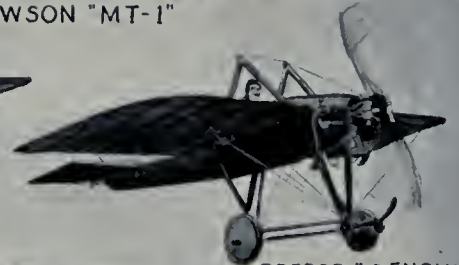

BREESE "PENGUIN"



CURTISS "H12" FLYING BOAT



STURTEVANT "S"



WRIGHT-MARTIN "F.B.A." FLYING BOAT



STANDARD "D" TWIN HYDRO

McLaughlin

INDEX

Abnormal weather conditions 259
 "Aces" 63, 64
 Act of Congress 205
 Acetylene process 177
 Ader, Clement 240
 Aders, Avion 240
 Adhesive insulation 145
 Admiralty, British 91
 Advisory Committee of the Council 214
 A. E. G. 286
 Aerial Airway, Wilson 200
 beacon 286
 beacon, French 133
 combat 63
 League of America 199
 League of Germany 231
 lighthouses 134
 navigation 23
 operations, independent 7
 photography 198
 reconnaissance 157
 Reserve Corps 212
 standard 146
 supremacy 3
 touring 203
 Aerials 142, 143
 Aerials, dirigibles 143
 Aerials, methods of suspending 143
 Aero bases 25
 batteries 74
 cameras, care of 100, 106
 camera, Fabbri 103
 Aero Club of America
 186, 189, 199, 201, 202,
 203, 204, 206, 209, 210, 211, 212,
 214, 216, 217, 218, 219, 235, 237, 238
 Aero Club:
 France 203
 Illinois 201
 Italy 202
 Aerodromes 106, 125, 128, 130
 Aerodynamic comparison 275
 Aerodynamic forces 256
 Aerofan 154
 Aerofoil 252
 Aeromap 197, 202
 Aeromarine 291
 Aero messages 117, 118
 Aeronautic appropriation 214
 cartography 200
 communication 139
 division, Signal Corps 204, 205
 Aeronautic engineers 245
 personnel, regulations for uniforms 190
 Aeronautics 157, 159
 Aeronautics at outbreak of war 240
 Aeronautics, history, U. S. Army 204
 Aero observer
 70, 71, 72, 74, 91, 113, 114, 116, 142
 Aero-Personnel Division 180, 181, 182, 185
 Aerophotography 91, 92,
 93, 94, 95, 96-97, 98, 99, 100, 101,
 102, 103, 104, 105, 106, 107, 108,
 109
 Aerophotography, directions 108
 elevation 101
 interpreter 101
 methods 95
 organization 93
 plates 104
 reading 98, 105
 technical 97
 Aeroplane aerial 146
 and infantry 121
 armament 41
 armor 50
 batteries 68
 bombs 94
 cannon 48
 collapse 46
 communication 121
 contact patrol 111, 121
 De Laison 119
 Aeroplane equipment 133
 fighting 113
 first use for military purposes 231
 for spotting 54
 guns 48, 49
 installation, wireless 145
 invisibility at night 125
 leading American 242
 measurements and performances 44
 metal construction 250
 night flying 125
 night landing 135
 night patrol 125
 performances 279
 problems of construction 245
 radio equipment 139
 radio set, Washington 153

Aeroplane equipment—Continued

searchlight 128
 signals from ground 121
 testing 259, 267
 tests 266
 Acroplanes 8, 44, 71, 72, 78, 84, 261, 274
 A. E. G. 288
 Aeromarine 291
 Ago 43, 286
 Albatros 44, 286, 288, 294
 Antoinette 228
 Anzani 228, 244
 Armstrong-Withworth 285
 A. R. or A. L. O. 288
 Aviatik 285
 Avro 284
 Berckmans Scout 292
 Breese "Penguin" 292
 Breguet 15, 28, 120, 148, 288, 284
 Bristol 286
 Burgess 207
 Burgess-Dunne 207, 292
 Caproni 278, 289
 Caudron 15, 42, 60, 73, 106, 139, 220, 285
 Continental Pusber 291
 Curtiss 205, 207, 291, 292
 Curtiss tractor 183
 De Havilland 288, 287
 Deperdussin 228
 Dorand 15, 42
 Farman 15, 16, 42, 93, 121, 228, 287
 F. E. 283
 Fokker 43, 284, 290
 French 125
 French, Letort 49
 German 86, 93, 129
 Gotba 289
 Goupy 228
 Halberstadt 43, 286
 Handley Page 16, 276, 289
 Lawson "M. T. I." 292
 Letore 15, 288
 L. V. G. 287
 L. W. F. 291
 Moineau 15
 Martinside 286
 Morane-Borel 228
 Morane monoplane 288
 Morane-Saulnier 286, 288
 Nieuport 46, 121, 228, 284
 Ordnance Engineering 291
 Paul Schmidt 285
 Paulban 228
 Pierce Sport Tractor 292
 Pilot Observer 119
 Pomilio aeroplane 19, 44
 R. E. P. 228
 Roland 43, 283
 Rumpler 44, 288
 Salmons-Morineau 287
 Savary 228
 Sopwith 42, 118, 283
 Spad 41, 44, 122, 288
 Standard 292
 Sturtevant 292
 Taube 130
 Thomas Morse 292
 United Eastern 291
 Vickers 284
 Voisin 15, 228, 290
 Wittmann-Lewis 291
 Wright 204, 207, 292
 Zodiac 228
 Aero raids on England 20
 Aero range finder 31
 Aero searchlight 128
 Aero Squadron 208
 Aerostatic Section, U. S. Army 163
 Agassiz Geological Museum 105
 Ago 286
 Ailerons 262
 Air compass 272
 Aircraft Board 219
 guns 39
 performances, measuring 259
 Production Board 201, 214, 217, 219
 productions 218
 reconnaissance 116
 wireless 138, 139
 Air duels 53, 55
 fan driven pumps 249
 lines 200
 navigation 197
 offensive 58
 pockets 250
 pressure gauges 249
 Air raids, list of 18
 scout 111
 speed indicator or meter 24

Akron, O., Goodyear School 156
 Alaskan pea jacket 196
 Albatros 285, 286, 288
 Allen, F. A. 282
 Allen, F. H. 217
 Allen, James 225
 Allies 91
 aerodromes 125
 aeroplanes 93
 aviators 90
 balloons 157
 raids, long distance 18
 wireless 141
 wireless sets 146
 Alps, crossing by aeroplane 6
 Alternator 143, 146, 148
 Altimeter 24, 126
 Altitude photographs 108
 Aluminum-caustic soda process 174
 Aluminum-potassium cyanide process 177
 America 185
 aviators 93
 "Blimp" 156, 157
 competition 228
 crankcases 257
 manufacturers of hydrogen 175
 training machines 212
 Anchors and ropes 158
 Anemeters 165, 270, 273
 Aneroid 259, 262, 263
 Angle of attack 252, 254
 Anti-aircraft batteries 93
 guns 86, 114, 125
 post 177
 Antoinette 228
 Appendix 158
 Appendix line 158
 Appendix ring 158
 Application of aircraft 238
 Archdeacon, Earnest 226
 Arc, potential 150
 Arkansas 210
 Armatures 146
 Armed photographic planes 54
 Armstrong-Withworth plane 285
 Army, U. S. aeronautics 204
 Air Service 180, 181, 182
 aviation field 212
 Aviation school 212
 aviation school training 185
 aviation students 180
 balloon school 167
 Deficiency Bill 208
 Arnold, Bion J. 201
 Arnold, Lieut. H. H. 204
 Artillery 81
 bombardment 122
 fire 71, 74
 fire by wireless 141, 149
 fire, directing 72, 160
 regulation 269
 Ascensional forces, table 162
 Ascensions 83
 Astor, Vincent 201
 Astra 228
 Astra Wright 228
 Atlantic Aeroplane 236, 242
 Atmospheric conditions 165
 Atmospheric density 259, 266
 Atmospheric pressure 260
 Austria 11, 111, 157
 Austrian armies 112
 Austrian bases 241
 Automatic ball float valve 242
 Automatic pilot 25, 27, 269, 270, 272
 Automobile windlass 82
 Division signal corps 179
 Aviatik 293
 Aviation beacons 14
 field, College Park 207
 mechanics 193, 195
 mechanics, insignia 190
 officers 195
 officer's insignia 195
 School, Army 212
 School, Curtiss 204
 School of Military Aerostatics (Ground schools) 182
 Massachusetts Institute of Technology, Boston 182
 Cornell University, Ithaca, N. Y. 182
 Ohio State University, Columbus, O. 182
 University of Illinois, Urbana, Ill. 182
 Texas University, Austin 182
 University of California, Berkeley 183
 Georgia University, Institute of Technology, Atlanta 183
 Section, Signal Corps 93, 180, 194, 195, 206, 207, 213

- Section, Signal Corps—Continued
 Section, Signal Corps, uniforms..... 190
 Aviation, Training camp..... 182
 Belleville, Ill., operating..... 182
 Fairfield, O. (Wilbur Wright Field) operating..... 182
 Fort Sill, Okla., advanced..... 182
 Mineola, N. Y., operating..... 182
 Mt. Clements, Mich. (Schltridge Field) operating..... 182
 Rantoul, Ill. (Chanute Field) operating..... 182
 Rocky Mountain Reserve..... 182
 San Antonio, Texas, operating..... 182
 San Diego, Cal., operating..... 182
 So. Mississippi Valley, Under investigation..... 182
 Aviation students..... 187
 Aviator, Allied..... 90, 91
 Aviators, American..... 93, 282
 certificates..... 186, 187
 face masks..... 191
 gloves..... 191, 192
 messengers..... 195
 service..... 192, 194
 uniforms..... 195
 Avion, Clement Ader's..... 240
 Avro aeroplane..... 15, 298
- Back pressure..... 251
 Bagnell, Lieut. Edwrd..... 211
 Bairn, Chief mechanic..... 211
 Baker, George F. Jr..... 201
 Baker, Secretary of War..... 298
 Balance of power..... 3
 Balancing free balloons..... 163
 Baldwin, Captain Thomas S..... 204
 Baldwin dirigible..... 205
 Balkan Mountains..... 17
 Ballast, sacks..... 83
 Balloons..... 83, 84, 157, 159, 163
 ballast..... 163
 cars..... 164
 capacity..... 161
 captive..... 74, 75, 81, 85
 Caquot..... 160, 81, 160
 companies..... 160
 dirigible pilot certificates..... 187
 Division..... 179
 envelope..... 158, 164
 equator..... 158
 fabrics..... 164
 historic..... 111, 112
 inflation..... 82
 kite..... 76, 81, 83, 84, 87, 96, 157, 157
 maneuver..... 88
 nurse..... 86, 160
 observation..... 84, 96, 156
 school, Fort Omaha..... 161, 167, 213
 Bamberger, Lieut. R. S..... 204
 Barometer..... 157
 Barrage fire..... 70
 Bartlett, Capt. Robert A..... 201
 Barnch, Bernard H..... 201, 214
 Batselder, A. G..... 201
 Battery, hydrogen cylinders..... 171
 Battleplanes..... 39
 B. E. (Blériot Experimental)..... 284
 Beachy air ships..... 157
 Beacon, aerial..... 133
 Beacon, electric flashlight..... 136
 Beacons, Germans'..... 130
 Beck, Lieut. Paul W..... 204
 Belgian cities..... 25
 Belgium, invasion..... 240, 241
 Bellanger, Capt..... 234
 Belmont, August..... 201
 Bennett, James Gordon..... 201
 Benoist Aircraft Co..... 242
 Berlin..... 25
 Best, E. C..... 210
 Bethenods high frequency generator..... 143
 Bethenods resonance alternator..... 143
 Bevans, K. J..... 211
 Bingham, Prof. Hiram..... 215
 Bishop, Courtland F..... 201
 Blades, variable pitch propeller..... 254, 255
 Blériot, Louis..... 226
 "Blimp"
 American..... 156, 161
 British..... 173, 177
 Goodyear..... 175
 Bliss, Mrs. William H..... 209, 211
 Board of Governors, Aero Club of America..... 234
 Board of Ordnance and Fortification..... 222, 223
 Body resistance..... 275
 Boeing Airplane Co..... 242
 Boelke, Captain..... 64, 65, 93, 241
 Boger, P. Jr..... 210, 211
 Bolling, Capt. Raynal C..... 209, 210, 211
 Bomb..... 87
 Barlow..... 37
 description..... 22
 dropping..... 26, 31, 239, 273
 falling curves..... 36
 initial velocity..... 35
 releasing device..... 36
 sights..... 22, 273
 Bombarding machines..... 54
 Bombardment..... 70, 269, 271, 272
 Bombardment, French..... 70
- Bombing..... 122
 attacks..... 9
 enemy bases..... 4
 night raids..... 125
 parties..... 125
 raids, list of..... 18
 raids, long distance..... 17
 damage done..... 20
 incendiary..... 20, 34
 types of..... 22, 31
 Bond, Brig. General John C..... 212
 Bonvalot, Gabriel..... 232
 Boots, rubber wading..... 193
 Bowen, Lieut. T. S..... 208
 Brake horse power..... 255
 Brake, for landing..... 251
 Breeches, winter motorcycle..... 193
 Breesc Penguin..... 300
 Breguet aeroplane..... 292, 298
 Breguet-Michelin war plane..... 21
 Bright, British authority..... 132
 Bristol, Cnpt. Mark L..... 201
 Bristol Scout Aeroplane..... 292
 British aero photographs..... 93
 British aeroplane, Vickers pusher biplane..... 58
 airship..... 167
 armies..... 171
 army tests..... 239
 blimps..... 173
 Commission in U. S..... 217
 De Havilland scout biplane..... 58
 flying corps..... 217
 forces..... 91
 General staff..... 56
 Government..... 241
 Government specification, wireless..... 145
 guns..... 82
 Naval Air Service, instruments..... 24
 Royal Navy Air Service..... 76, 104
 War Office..... 239
 Wright Co..... 263
 Brush discharge..... 145
 Buc, France..... 230
 Buffalo Aero Squadron..... 210
 Buffalo, N. Y..... 210
 Bulkheads..... 248
 Bullets vs. high explosive shells..... 51
 Bureau of Construction and Repair..... 214
 Burgess aeroplane..... 207, 244
 Burgess Dunne aeroplane..... 207
 Burgess, Dr. G. K..... 213
 Burgess, W. Starling..... 201
 Burns, K. J..... 210
 Byrd, Lieut. D. B..... 211
- Cable, A. G..... 214
 Cabot, Godfrey L..... 201
 Coffyn, Capt. Frauk T..... 215
 Calcium chloride..... 169
 Calibration tests..... 267, 268
 California Aviation School..... 213
 Camera..... 91, 106, 107, 117, 264
 care of..... 97
 construction..... 104
 Eastman aero..... 102
 Fabbri..... 103
 Howarth..... 102
 long focus..... 102
 stereoscopic..... 102
 types of..... 105
 Camouflage..... 113
 Camshaft..... 257
 Canadiana photographer..... 96
 Cbauning, J. Parke..... 201
 Cautou, Brigadier-General F. M..... 211
 Cautou, Unna..... 228
 Capacity tanks..... 230
 Caproni planes..... 12, 13, 50, 241, 278, 295
 Caproui triplane..... 4, 13, 297
 Captain de Beaucaup..... 17
 Captain de Kerillis..... 17
 Captive balloons..... 71, 74, 75, 81, 85, 157, 159, 161
 Captive balloons vs. aeroplanes..... 85
 Caquot balloo..... 78, 81, 96, 160
 Coquet, Capt..... 78
 Carberry, Major Joseph E..... 201, 208
 Carburetor..... 252
 Carburetor headers..... 250
 Carlstrom, Victor..... 211
 Carlton, Newcomb..... 201
 Carliian, Lieut. M..... 210, 211
 Carrizal tragedy..... 209
 Carroll, Capt. P. A..... 215
 Carter, General..... 204
 Cases for a balloon inflation..... 165
 Case for large aeroplane..... 374
 Cartography aeronautic..... 200
 Caudron biplane..... 15, 42, 73, 139, 285-290-298
 Caudron potash..... 170
 Ceiling of machine..... 261
 Celoria, Senator G..... 203
 Central Powers, wireless..... 141
 Centrifugal forces..... 255
 Certificate, dirigible balloons..... 187
 hydroaeroplanes..... 188
 spherical balloons..... 187
 Chamberlain, Senator George E..... 213
 Chamber of Deputies, French..... 232
 Chambers, Capt. W. I..... 201
- Chandler, Major Charles de F..... 167, 201, 204, 208, 213
 Chnges of uniforms..... 193
 Changing speed..... 252
 Chanute, Octave..... 226
 Chapin, Roy D..... 201
 Chapman, Lieut. C. C..... 208
 Chase, Brig.-Gen. John..... 210
 Chicago Training Stntion..... 213
 Chief Aeronautic Engineers..... 245
 Contractor of Navy..... 219
 Inspector Military Aeroplanes..... 239, 240
 Signal Officer..... 181, 202, 213, 219, 223, 224, 225
- Christofferson..... 244
 Chrome vanadium steel..... 250
 Circuit of Eastern France..... 232
 Clark, Capt. V. E..... 245
 Clerget motor..... 228
 Climbing..... 253
 Clinometer..... 269
 Close formation flying..... 115
 Close reconnaissance..... 111
 Coast artillery..... 71, 194
 Coast defence..... 188
 Coast defence, function of aircraft..... 7
 Coast guard..... 237
 Coats, aviator, antisinking..... 190
 Coats, aviator, leather..... 194
 Cochran, Alex. Smith..... 201
 Coffin, Howard E..... 201, 214, 215, 217
 College Park, Md..... 204, 205, 207, 208, 209
 Collier, Robert J..... 201, 204, 206, 212
 Colonia Dublin..... 111
 Colorado..... 210
 Color filters..... 99
 Colt..... 49
 Columbus, N. M..... 208, 209, 210, 213
 Combat machines, tactics..... 54
 Commissioned personnel..... 161
 Committee on Aeronautic Maps and Land-
 ing Places..... 199, 201
 Committee on Military Affairs..... 213
 Committee of National Aviation..... 233
 Communication by Wireless..... 139
 Compass..... 24
 Compass bearings..... 117
 Conant, W. M..... 210
 Concealment..... 116
 Concentrating rings..... 158
 Condenser charging device..... 149, 150
 Condensers, wireless..... 145, 146
 Conger, Roy U..... 201
 Congress, Acts of..... 205, 206, 222, 237
 Connecticut..... 210
 Connecticut Coast Artillery..... 210
 Continental Pusher..... 291
 Construction of aeroplanes..... 245
 Construction of balloons..... 163
 Contact patrol..... 4, 112, 121
 Contact patrol machines..... 122
 Contest Committee, Aero Club of America..... 187
 Coolidge, T. Jefferson..... 209
 Cooling system..... 257
 Cooperation between balloon and artillery..... 77
 Council of National Defense..... 215, 235, 237, 243
 Coutelle..... 173
 Coyle, Lieut. Arthur J..... 211
 Craig, A. M..... 211
 Crankshaft bearings..... 257
 Culver, Major G. O..... 140, 201
 Culver radio apparatus..... 140
 Culver wireless set..... 146, 154
 Cummings, Lieut..... 210
 Curtiss aeroplane..... 204, 207, 236, 244, 300
 Curtiss Aviation School..... 204, 210, 211, 222
 Curtiss, Glenn H..... 201, 207, 222
 Curtiss JN. 4-B tractor model..... 12, 44, 201
 Curtiss triplane..... 12, 44, 201
 Curtiss Wireless Scout..... 44
 Curves of stress..... 256
- Dansette..... 228
 Dardanelles..... 91
 Dargue, Lieut. Herbert..... 76
 D'Arsouval..... 177
 Daucourt, Lieut..... 17
 Davis, Commauder Cleland..... 201
 Davis, Driggs..... 50
 Davison, Lieut. F. Trubee..... 201
 Day signalling..... 71
 Dayton, Ohio..... 226
 Dayton-Wright Co..... 244
 Deauration of oils..... 278
 Deeds, Lieut. Col. E. A..... 201, 214
 Defensive line..... 70
 Deficiency Bill..... 216
 De Havilland..... 283-287
 Delivering aeroplanes to Europe..... 245
 Density..... 259, 260
 Density of gases..... 263
 Density tables..... 268
 Department of Aeronautics..... 217, 219
 Designer..... 259
 Designs and tests of suspension patches..... 164
 Destructiveness of projectiles..... 40
 Detached flight..... 118
 Dick, F. R..... 210, 211
 Dickson, Charles..... 201

Dickinson, Lieut. Oliver P. 204
 Die-forging 250
 Dielectric constants 146
 Diffin, F. G. 202, 213
 Directing artillery fire 160
 4, 71, 72, 78, 139, 142, 160
 Dirigibles 125, 157, 158, 165
 Baldwin 205
 pilot's certificate 187
 first U. S. 204
 military 157
 naval 157
 wireless 143
 Distance reconnaissance 111
 District of Columbia 219
 Dive attack 65
 Dodd, Capt. T. F. 208, 245
 Dodgo, W. Earl 202
 Dope, inflammable 72
 Drag 275
 Drag roping 163
 Drift 117
 Drift coefficient 275
 Drift indicator 272
 Dropping bombs 22
 Duhilier condenser 145
 Duhilier system 137
 Duhilier, William 139, 253
 Dugouts, German 70
 Dumont, Alberto Santos 202
 Duesenberg motor 242
 Dusseldorf 7
 Duties of balloon personnel 164
 Dwyer, J. T. 210, 211

Eastman aero camera 102
 Economical speeds 254
 Effect of size on performance 279
 Effect of size on structural weight 279
 Electric flashlight beacon 136
 Electric headlights 25
 Electrical Review 177
 Electrolyzers 170
 Electrolyzers, American 171
 Electrolytic method 170
 Electrolytic plant 171
 Electro-magnetic controlled oscillator 151
 Ellis, Brig. Gen. H. Handy 210
 Elongated balloons 81, 159
 Emergency Air Fleet 11
 Enemy aircraft 160
 England 186, 259
 England, Brig. Gen. Lloyd 210
 England, night flying in 127
 English wireless apparatus 140
 Enlisted aviators, insignia 190
 Enlisted men, Aviation section 193
 Regular Army 181
 uniforms 195
 Enlisted personnel 161
 Enlisted Reserve 181
 Enlisted Reserve Proper 181
 Equipment, balloons companies 164
 Equipment, cost of 213
 Erierson, F. G. 213
 Essen 7, 10, 27
 Etampes 287
 European War 221, 245, 259
 Evans, Gen. Robert K. 202
 Evolution of military aeroplane 204
 Expansion of hydrogen 168
 Experiments at South Foreland 133
 Expert Aviator certificate 189

Fabbri photo apparatus 103
 Face masks for aviators 191, 193, 40
 Factors of air supremacy 46
 Factors of safety 186, 204
 F. A. I. Certificates 164
 F. A. I. rules 160
 Fall of shots 154
 Fan driven generator 295
 Farman, Henri. 15, 16, 93, 222, 282, 287, 295
 Farman biplane 121
 Farman reconnaissance biplane 211
 Favre, A. L. 210, 182
 Federal Reserve Officers' Training Camps 211
 Federal service 226
 Ferber, Capt. Louis 176
 Ferro-silicon 12, 288
 Fiat motors 256
 Fibre stress 71
 Field artillery 245
 Field artillery control 194
 Field companies 165
 Field compression outfits 160
 Field generators 165
 Field generators, hydrogen 63
 Fifth arm 57, 269, 270
 Fighting in the air 286
 Fighting machines 64
 Fighting pilots 58
 Fighting tactics 174
 Filling hydrogen cylinders 164
 Filling kite balloons 108
 Films vs. plates 245
 Fire control 251
 Fire safety device 221
 First aero appropriation 210, 211, 257

First aero appropriation—Continued 204
 dirigible 222
 flight 233
 gunplane 230
 military aero review 222
 requisition 223
 specifications 157
 spotting artillery fire 227
 tractor biplane, U. S. 229
 use of aeroplane in war 202
 Fiske, Rear Admiral Bradley A. 215
 Fitzgerald, Capt. S. W. 255
 Fixed blade propeller 252
 Fixed camber wings 128
 Flare lighting 130
 Flares 128
 Flare up 136
 Flashlight beacon 251
 Flexible piping 113
 Flight commanders 244
 Flint Aircraft Mfg. Co 251
 Floats, metal 282
 Flying Corps 131
 instruments 261
 level 125
 night 191, 194, 195
 suit, summer 191
 Fokker, batteries 67
 Fokker monoplane 241, 286, 290
 Folding landing gear 251
 Folding, packing, shipping balloons 163
 Forces of gases 163
 Formation, aerial fighting 63
 flying, laup signals 56
 flying, rules 28
 opposing 115
 reconnaissance 115
 Form of application, Officers' Corps 180
 Fort Hamidie 91
 Fort Myer 204, 205, 224, 225
 Fort Omaha 161, 167, 169, 170
 Fort Sau Houston 208
 Foulois, Benjamin 194, 204, 206, 208, 225
 French aerial beacon 133
 Aero Club 202
 aeroplane 125
 air raids 20
 air raids with British 18
 Army 230
 artillery 70
 aviation 231
 aviation camp 128
 aviators 86
 balloons 81
 bombardment 70
 bombing plauce 51
 French cameras 91
 dirigible 157
 Flying Corps 185, 203
 front 151
 government 282
 kite balloon 85
 landing system 128
 Military competition 226, 230
 Ministry of War 227, 231
 nightflying 127
 observers 105
 pilots 128
 scout 97
 trenches 107
 War Department 226
 wireless apparatus 140
 wireless trucks 144
 wireless set 147
 Franco-Prussian War 221
 Free balloons 163
 Free balloon training 161, 163
 Frost, Corp. B. C. 210
 Frost, D. G. 211
 Fuel capacity 245
 Fuel leads 250
 Fuel supply 257
 Full loads 254
 Funston, Gen. 208
 Fuselage 262
 Fuselage of aeroplane 36

Gallaudet Aircraft Corp. 244
 Garrison uniforms 195
 Garros, Roland 67
 Gary, Elbert H. 202
 Gas beacon 136
 Gas cylinders 87
 Gasoline supply 249
 Gasoliue supply system 248
 Geiger, Lieut. Harold 206
 General Aeronautic maps 197
 General aeroplane 244
 Generation and compression of hydrogen 163
 Generator 269
 Generator, wireless 147
 Geographical Congress 201
 Georgia 210
 Germany 81, 157, 210, 216, 233
 German aerial beacon 136
 aero camera 101, 102
 aerodromes at night 129
 aeroplanes 57, 79, 86, 93, 129
 German ammunition 57

German armed machines 47
 Automobile Constructor's Ass. 231
 aviation beacons 130
 bases 91
 biplane, A. E. G. 42
 cities 25
 combat machines 43
 costly failure 240
 defensive line 70
 dugouts 70
 government wireless 154
 hydrogen making 171
 hydrogen trucks 172
 naval bases 27
 positions 70
 Roland plane 46
 Rumpier plane 44
 Scout 97
 Spad 45
 Taube 154
 trenches 70
 War Department 231
 German wireless apparatus 140, 141
 communication 154
 stations 152
 Gillmore, R. J. 211
 Gliding angle 229
 Gloves for aviators, summer 192
 Gloves for aviators, winter 191
 Gnome 228
 Godfrey, Dr. Hollis 31, 32, 33
 Goerz range finder 31
 Goerz sighting telescope 217
 Goethals, Maj. Gen. 192, 193, 194
 Goggles 214
 Gompers, Samuel 161, 210, 211
 Goodrich, C. C. 156
 Goodyear Blimp 208
 Goodyear School, Akron, Ohio 280
 Gorrell, Lieut. E. S. 289
 Gotha 14, 79
 Gotha battleplane 3
 Gotha biplanes 59
 Gotha biplane, fusilage 79
 Gotha gunners 185
 Graduate School of Military Aeronautics 204, 210
 Graham, Lieut. Harry 240
 Graig, A. M. 157
 Gravity service tanks 83
 Great Britain's Dirigibles 193
 Ground cloth 183
 Ground School of Military Aeronautics 121
 Ground signal sheets 115
 Guerilla tactics 163
 Guide and anchor rope toggle 5
 Guide rope 71
 Guillaume, Trench 72
 Gunncre, aero 139
 Guns, largo caliber 67
 Lewis 54
 mounting on aeroplanes 72
 mounts 31
 Vickers 247
 Guynemer, Capt. 26, 273
 Gyroscope efforts 256
 Gyro manual control 269, 271
 Gyroscopic moments 269, 271
 Gyroscopic unit 210, 211

Hagerty, Corp. E. B. 210, 211
 Halberstadt 286
 Hall, Brig.-Gen. P. L. 210
 Hall, E. S. 219
 Hammond, John Hays 202
 Hand air pressure pumps 249
 Hand control lever 269, 270, 272
 Handley-Page warplane 12, 47, 274, 276, 287
 Handley, Sergeant Harrison 211
 Hangara 209
 Hangars, illumination 127
 Handling captive balloon windlass 164
 Hannay, Maj. D. R. 77
 Hare, James H. 206
 Harriman, W. Averill 202
 Hawley, Alan R. 101, 202, 216, 217, 243
 Hawley, William 202
 Heavier than air machines 223
 Heinrich Corp. 244
 Helicopters 226
 7, 25
 Heligoland 192, 193
 Helmets, aviator's 204, 206
 Hennessey, Capt. Frederick B. 210, 211
 Henry, P. J. 100, 106
 Herbert and Husgen 213
 Herck, Capt. J. 141
 Hertz wireless experiments 211
 Hickman, Willis G. 51
 High explosive shells 156
 Hindenburg statue 206, 211
 History of aeronautics 204, 219
 History of U. S. Army aeronautics 148
 Homogeneous dielectrics 131, 210
 Honig, Edgar 131
 Honig circles 193
 Hood 211
 Hoppin, F. L. V. 272
 Horizontal reference 247
 Horizontal surfaces 49
 Hotchkiss, Gen. 49

- Hough, Brig. Gen. W. B. 211
House Committee on Military Affairs 214
Howard, Brig. Gen. C. W. 211
Howell, W. T. 210, 211
Howitzers 71
Hoyer, Lient. R. H. 211
Hohhard, J. F. 210, 211
Hulbert, Congressman Murray 219, 243
Humphreys, Lieut. Frederick E. 204
Hutchings, Brig. Gen. H. 211
Hydraulic tests of gas cylinders 163
Hydroaeroplane pilot's certificate 188
Hydrogen 84
 American manufacturera 175
 carriers 169
 cylinders 160
 field generators 176
 for military purposes 167
 from water gas 176
 portable gas plant 170
 Silicol process 171
 supply 160
 trucks, German 172
Hydrogenite 176
Hydrolite 175
- Immelmann, Lieut. 65, 66, 241
Imperial Aero Club 231
Imperial Automobile Club 231
Improvements in design 257
Incendiary bombs 20
Incendiary rockets 159
Inclinometer 24, 126
Identification badge 196
Indenting for stores 97
Independent Interrupter 142
Induction coil 142
Inflammable dope 72
Inflation of balloons 82, 163
Insignia 190, 199
 Insignia, sleeve 193
 Inspection, balloon envelope and net 164
 Inspection window 158
 Installation, wireless 138
 Instructions for aero photography 91, 109
 Instructional aeroplanes 240
 Instruments 14, 23, 24, 126
 Instruments, sighting telescope 31
 Internationals Aeronautic Federation 186, 201
 International Aircraft Standardization Committee 213
 International Convention on Aeronautic Cartography 200
 International Geographical Congress 201
 Invisibility of aeroplanes 125
 Iron contact process 172
 Isotta Fraschini motors 12, 13
 Italian Aeronautic Topography aeroplanes 203
 aeroplanes 157
 airscont 229
 Commission on Aeronautics in U. S. 10
 raids 19
 theatre of war 19
 Turkish War 232
 Italians 241
 Italy, aeronautic map 202
- Janney Aircraft Co. 244
Jenkins, W. C. 210, 211
Johannistal beacon 136
Johnson, Corp. Greenhow 212
Johnson, W. J. 210, 211
Joint Army and Navy Committee 204
Joy, Henry B. 202
Junior Military Aviators 179, 186, 192, 194
Junior Military Aviator's insignia 190
Junior Squadron 183
Junior Wing, Instruction 184
- Kaiser's prize 230
Karlsruhe raid 17
Kelley, G. E. M. 204
Kentucky 210
Kiel 7, 10, 25, 27, 29
Kiel Canal 18, 25
Kiel, raid on 30
Kilmer, Lieut. W. G. 208, 215
Kinematograph 96
King and Queen of England 47
Kirtland, Lient. R. Carrington 204
Kite balloon 71, 77, 81, 83, 84, 85, 87, 91, 96, 157, 163, 164
 Canadian 88
 company 83
 steering bsgs 164
 truck 159
 unit 82
Kite observer 99
Kitty Hawk 226
Klaxon horn 121
Knowlson, R. J. 210, 211
Kodja Chal 91
Kollasa 85
Konant, W. W. Jr. 211
Kruass, Serj. E. A. 210, 211
- Laffon, Lient. 66
Lahm, Maj. Frank Purdy 76, 202, 204, 205
Laird Aviation Co. 244
Lambert, Capt. A. B. 202
Lallemand, Charles 203
- Lamp signals, formation flying 56
Landing brakes 251
 gear 251
 ground 127, 132
 places 198, 199
 spots for balloons 163
 stations 127
Langley, C. P. 222, 223, 226
Langley Aerodrome 223
Langley Field 173
Lanzuis Aircraft Co. 244
Large aeroplane, case of 274
Large warplanes 241
Large Zeppelin apparatus 138
Law, Ruth 25
Lawson "M T-1" 292
Leading American aeroplane 244
Lehaudy dirigible 157
Lefrance, Jean-Abel 31
Le Large, Capt. 172
Leggins 193
Lenses 104
Letord 15, 288
Levant air raids 20
Lewis gun 48, 52, 61, 72, 139, 208
Life Saving Service 237
Lift coefficient 275
Lighthouses, aerial 134
Lighting aerodromes 127
Lighting equipment for aeroplanes 133
Light scout aeroplanes 240
Lighting stand 131
Lights for landing grounds 132
Liquid pressure gauge 261
Line of direction 102
Line of reconnaissance 111
Literary Digest 131
Local strength 279
Local or artillery reconnaissance 112
Lockhart, Henry, Jr. 202
Logy 247
London 126
London Aeronautics 127
Long distance flights 187
Lond distance raids 125
Long Island Map 200
Lovett, Lieut. Robert A. 202
L-section 250
Ludwigshafen raid 17
L. W. F. aeroplane 271
L. W. F. Engineering Co. 244
L. V. G. 287
- Machine guns, mounting 67
Magnetic forces, wireless 151
Magnetos 257
Major aerial operations 241
Mann, Congressman James R. 213
Manoeuvring and pressure valves 164
Manoeuvring valve 163
Map holder, Sperry 201
Maps 74, 75, 91, 113, 197
Map with photograph of route 200
Marconi Co., wireless 155
Marconi wireless experiments 141
Mariner's chart 197
Martin aeroplane 207
Martin, Dr. Franklin 214
Martinside 286
Massachusetts Institute of Technology 216
Maurice Farman hiplane, wireless 147
Mauser Works, Oberndorf 18
Maximotor 244
Maxim, Sir Hiram 48, 222
McClasky, Lieut. J. W. 204
McCormick, E. 210
McCormick, Harold F. 202
McCoy, Capt. J. C. 202
McDaniels, Lieut. Curry A. 211
McGregor, J. S. 213
McMillin, Capt. Ralph E. 210
McMillin, Emerson 202, 209, 232
McMullen, Lieut. Byron 211
Mean density 260
Mean pressure 260
Mean temperature 260
Measuring aircraft performances 259
Mechanical interrupters 150
Mechanica of the aeroplane 238
Mercedes engines 3, 288
Merica, P. D. 213
Messengers, motorcycle 194
Messerschmitt, A. 173
Metal construction for aeroplanes 250
Metal floats 251
Meteorology 165
Mexican campaign 206, 208, 231
Mexico, punitive expedition 111
Mexican War 204
Meyers, Eugene, Jr. 202
M. F. P. Aero Co. 244
Michelin, M. 47
Mignot, Lieut. M. 213
Military aeroplanes 245, 249, 257
 aeroplanes, evolution 222
 aerodromes 106, 135
 aerostatics 157
 aviators 170, 102, 104
 aviator's insignia 190
 dirigibles 157
 load 245
- Military aeroplanes—Continued C
 maps 197
 observation balloons 158
 Military operations 91, 197
 operations with aircraft 5
 service 167
 seaplane supply system 249
 Miller, Capt. James E. 202, 214
 Millerand, M. 233
 Millevoje, M. 233
 Milling, Lieut. T. de Witt 204, 208
 Mineola, Long Island 216, 211, 215
 Minnesota 210
 Moineau 47
 Monastir, photo 22
 Monoplane, Morane 287
 Montariol, Lient. 185
 Montgomery, R. L. 214, 215
 Morane-Saulnier 207, 241, 286-287-288
 More, Morgan 211
 Morse code 77, 121, 128, 134
 Morse, D. P. 210, 211
 Motion picture films 108
 Motor Boating 29
 Motor, Baerdinorear or Clerget 43
 Competition, Kaiser's 230
 Motor, Canton-Unné 39
 car wireless station 138
 Isotta Fraschini 50
 Servo 269, 270
 transports 169
 trucks 160
 truck operation 164
 Fiat 12
 Rolls-Royce 274
 (See Textbook of Naval Aeronautics).
Mouillard 226
Mount Cornillet 91
Mullers, aviator's 195
Muller requirements 251
Mulock, Lieut. R. H. 134
Multiplane 232
Munich raid 18
Mustin, Lieut. Commander Henry C. 202
Muzzle velocity 52
- Nash, Brig.-Gen. Van Holt 210
National Advisory Committee on Aeronautics 214
 Aerial Coast Patrol Commission 245
 Aeroplane Fund 235
 Guard of New York 209, 213
 Naval dirigibles (See Textbook, Naval Aeronautics).
 maps 197
 observers 91
 Navarre, Lieut. 64, 241
 Navigating instruments (See Textbook, Naval Aeronautics) 126
 Navigation lights 25
 Navy Department 204
 Navy Department, Pensacola 173
 Nebraska 210
 Net toggles 158
 New Hampshire 211
 Newport News, Virginia 210
 Newton, Byron R. 235
 New York 210
 New York National Guard 209
 New York to Albany map 198
 New York to Chicago map 199
 New York to Newport News map 199
 New York to San Francisco map 199, 200
 New York World 212, 236
 Nieuport aeroplane 4, 7, 121, 284
 Night bombing 21, 23
 flying 25, 73, 125, 127, 130, 131, 133, 272
 landings 126, 128, 135
 landing sights 24
 lights 132
 patrol 125
 operation of aeroplanes 126
 raids 10, 125
 signalling 71, 132
 use of balloons 159
 Nocturnal flyers 130
 Non-recoil gun mounts 54
 Normal atmosphere 261
 Norris, G. L. 213
 North Carolina 211
 North Pole 200
 North Sea 136
 Noyes, Corp. D. R. 210
 Nurao, balloon 86
- Observation balloons 86, 96, 156, 157, 158, 160
"Observe for line" 75
"Observe for range" 76
Observed air speed 268
Observer, wireless 147
Observer, wireless signaling 149
Observers 71, 72, 74, 84, 87, 91, 99, 113, 114, 116, 118, 119, 122, 125
Odell, Quartermaster Serj. W. T. 210, 211
Offensive, fighting tactics 68
Officers' Reserve Corps, form of application 180
Oil consumption 230
Oiling system 257
Ohio 211
Oklahoma 211

- Olyphant, R. M. Jr. 210, 211
 Omaha 163, 204
 One-place machines 246
 Operation of balloons 213
 Opposing formation 115
 Orders of reconnaissance 116
 Ordnance Engineering 291
 Oregon 211
 Organization and Training Division 182
 Organization of halloon companies 164
 Oshorn, Lieut. B. 210
 Oscillation 247
 Oscillating circuits 141, 145, 149, 151
 Ostend 7, 27, 91
 Oversea reconnaissance 246
- Pallone-Cervo Volante 85
 Palmer, George M. 210
 Pan Americanism 222, 237
 Pan American Aeronautic Exposition 222
 Paper kites 159
 Parahellum gun 48
 Parachute 87, 88
 Parasite resistance 245
 Paris 125, 241, 282
 Aero Show 232
 Madrid Race 232
 Rome Race 232
 siege 111
 Parke, J. D. 202
 Patrolling aeroplanes 110, 125
 Paul Schmitt 285
 Payne, S. G. 213
 Peary, Rear Admiral Robert E. 201, 217, 238, 239
- Pedals 270
 Pendulums 272
 Pensacola 173
 Performance curves 252, 253, 254
 Perfetti, Maj. R. 10, 11
 Perkius, George W. 202
 Permanent air routes 197, 199
 Permeability of gases 164
 Parmelee, P. O. 204, 206
 Pershing, Gen. John J. 111, 128, 208, 209
 Personnel Division, U. S. Signal Corps 180
 Pursuit or combat machines 43
Petit Journal 233
Petit Parisian 233
 Petrol consumption 264
 Petrol flares 127, 133
 Peugeot 47
 Philippines 204
 Photographic Corps 93
 machines 4
 maps 91, 200
 maps of sectors 198
 positions 105
 Photographing enemy positions 4
 Photography 91
 aero 198
 altitude 108
 halloon 164
 Pilot 117, 130, 270, 280
 halloon 158
 certificate 204
 certificate, spherical balloons 187
 hydroaeroplane 187
 cockpit 240
 -observer 269
 Pilot signals 129
 Sperry automatic 269
 Pistol camera 101
 Plates vs. films 109
 Plessis-Belleville 66
 Pomilio, Capt. A. 213
 Roncagli, Commander Giovanni 203
 Poor, Prof. Charles L. 202
 Portable aerial beacon 133
 field generators 160
 gas beacon 133
 hydrogen gas plant 170
 wireless sets 140
 Position 41
 Position of aeroplane guns 68
 Post, Augustus 63, 81, 217
 Potomac River 222
 Powerplant 245
 Preliminary flying test, U. S. Army 189
 Preliminary Training Tractor 242
 Prentice, W. F. 213
 President Manuel Estrada, of Guatemala 201
 President Wilson 214, 218, 219, 230
 Primary Military Tractor 244
 Prince Henry of Prussia 230, 232
 Prince, Lieut. 217
 Prince, Norman 241
 Principles of aerial combat 63
 Problems in aeroplane construction 245
 Problems in aerophotography 91
 Propellers, fixed blade 253, 255
 for variable pitch angle 253, 255
 stresses 255
 variable pitch 253
 Properties of hydrogen 167
 Property damages from halloons 164
 Protecting aeroplanes 121
 Protecting reconnaissance machines 115
 Pulitzer, Ralph 202, 212
 Purifying hydrogen 169
 Pursuit machines 40, 246
- Pushers 247
- Quartermaster Corps 194
- Rader, Lieut. Ira D. 208
 Radian 256
 R. A. F. 260, 277
 Raiding 39
 Raids 79
 maps 197
 night 125
 Zeppelin 125
 Radio Communication 139
 Division, U. S. Navy 155
 engineers 148
 for aeroplanes 139
 frequencies 152
 set, Washington 154
 Radians of action 253
 Railway truck for hydrogen 174
 Reber, Maj. Samuel 202, 204
 Receiving station, wireless 151
 Receiving trucks, wireless 144
 Reconnaissance 111, 112, 245, 269
 aeroplane 240
 machines 115, 121
 patrol 114
 Reconnoitering 4
 Red sack for ripping-panel cord 158
 Reed, Lieut. Charles 215
 Reference plane 269
 Regular air lines 200
 Regular Army 179, 180, 186
 Regulating artillery fire 271
 Regulation for uniforms of U. S. Aero-
 nautic personnel 190, 193
 Relief map 179
 Renault motor 15, 232
 Representative American aeroplanes 244
 Reserve Military Aviators 179, 186
 Reserve Officers' Aviation Section, Signal
 Corps 214
 Reserve Officers (flying duty) 181
 Reserve Officers (non-flying duty) 181
 Resistance 247
 Reverse bending 256
 Revolving commutators 152
 Reynolds, C. H. 210, 211, 234
 Ribel, Oscar 63
 Reid, Ogden Mills 202
 Rigging truck 82
 R. M. A. certificates 189
 Rip panels 163, 264
 Roberts motor 244
 Robinson motor 244
 Rockwell, W. L. 210, 211
 Rogan, Brig. Gen. C. B. 211
 Rogers, A. B. 213
 Roland 283
 Rolls-Royce motors 288
 Rosewald, Julius 214
 Rotation in pitch 256
 Rouzet 146
 Royal Aircraft Factory 13, 259
 Royal Air Service 13, 15
 Royal Flying Corps 6, 15, 77, 259
 Rubber wading hoots 194
 Rumpler 47, 288
 Russel, R. F. 210, 211
 Russia 157, 174
 Russian air scout 120
 halloons 86
 machines, Sykorsky 55, 240
 Ryan, Thomas F. 202
- S. A. E. 250
 Safety device 251
 Safety point 92
 Sales, Brig. Gen. W. W. 212
 Salmon, Corp. H. H. 210, 211
 Salmson-Moinian 287
 Salonika 9, 10, 17, 33, 125
 San Antonio 204, 208
 San Diego 204, 205, 211, 213
 San Marsano, Charles de 201
 Santos-Dumont, Alberto 226
 Sausage 81, 84, 159
 Schools, Curtiss aviation 204
 of military aeronautics 182
 Schuckert generators 171, 172
 Scientific American 178
 Scott, Gen. 202
 Seaplane (See Textbook Naval Aeronautics) 248
 Searchlights 126, 127, 128, 136, 272
 Searchlight signaling 128
 Second and Third Aero Squadrons 213
 Secretary of Aero Club of America 187
 War, U. S. 190, 206, 208, 217, 218, 219
 Seeing wireless signals 138
 Seiberling, Frank A. 202
 Selfridge, Lieut. E. 204
 Selfridge Field 224
 Semi-rigid dirigibles 157
 Senior Squadron 183
 Senior Wing, instructions 184
 Service cap 195
 Servo motor 270, 288
 Shapes of halloons 164
 Sharp, Ambassador 202
 Shaw, Edwin C. 202
 Sheldon, Lieut. Harold P. 212
- Sheppard-Hulbert Bill 217
 Sheppard, Senator Morris 219, 243
 Sherman, Lieut. William G. 204
 Shinnecock 244
 Shoes, aviator, winter 193
 Shooting through propellers 68
 Short range reconnaissance 246
 Shrapnel 71, 72
 Sideslips 131
 Siege warfare 160
 Siemens Bros. Co. 171
 Signal codes 128
 Signal Corps 161, 175, 182, 192, 193, 194, 204, 206, 207, 212, 213, 219, 223, 245
 Signal Enlisted Reserve 181, 182
 Signal Enlisted Reserve Corps 179
 Signal Equipment 132
 Signaling 71, 72, 77, 80, 86
 Signaling by searchlight 128
 Signaling to aeroplane 174
 Signal Officers' Reserve Corps 179, 182, 211
 Signals at night 133
 for night flyers 131
 from balloons 160
 Silencers 21
 Silico-Acetylene process 178
 Silicof process, hydrogen 171
 Simon, E. J. 155
 Simmons, Lieut. H. H. 215
 Shock absorbers for landing gear 251
 Shoulder loops 190
 Skill in piloting 41
 Skill in taking photos 104
 Sykorsky 55
 Small power wireless sets 140
 Smith, P. D. 210, 211
 Smith, Serg. L. V. 210
 Sofa 17
 Somme, photo 5
 Sopwith aeroplanes 60, 118, 241, 244, 283
 Sopwith factories 47
 Sorbonne 233
 South Foreland experiment 133
 Spads aeroplanes 241, 288
 Spark electrodes 147
 Spark gap 140, 141
 Special aeronautic maps 197
 Specifications for uniforms 190
 Speed 40
 Speed course tests 266
 Speed indicators 267
 Speed in tactics 64
 Speed scout 242
 Sperry automatic pilot 25, 269, 271
 homh sight 19, 35
 Gyroscope Co. 155
 Lawrence B. 25, 199, 202, 210, 269
 map holder 201
 Speyers, J. R. 211
 Spherical halloons 81, 158, 159
 Spherical halloon pilot's certificate 186
 Spirit level lateral inclinometer 24
 Spotting aeroplanes 54
 Spotting artillery fire 71, 72, 73, 77, 153
 Spreading balloon envelopes 163
 Squadron commanders 113
 Squadron flight 117
 Squires, Brig. Gen. George O. 202, 204, 205, 206, 209, 214, 215, 217
- Stability 239
 Stallometer 269
 Stamford 210
 Standard aeroplane 244-292
 Standard aeroplane aerial 146
 Standard aero-squadrons 186
 Standard atmosphere 261
 Standard density 260, 261, 268
 Starting field 245
 Starting motor for engines 248
 Statoscope 158, 262, 263
 Steel aluminium alloy 250
 Steel battleplane 244
 Steel spring shock absorber 251
 Steel tractor 244
 Steeple banked turn 256
 Steinmetz, Joseph A. 217
 Stephens, James S. 202
 Sterling Telephone Co. 140
 Stovenson, Serg. J. H. 210, 211
 St. Louis Balloon Race 101
 Stockton, P. R. 211
 Strategic-reconnaissance machines 245
 Stream line tank 250
 Structural 279
 Students, wireless 141
 Stupar tractor 144
 Sturtevant aeroplane 244, 291, 292
 Sulphuric acid 169
 Summer flying suit 191
 Supply of gasoline 249
 Supply gauge 251
 Supply tanks 258
 Sullivan, J. D. 210, 211
 Supremacy of the air 39
 Swashhaffle plates 248
 Synchronized spark gap 146, 147, 148
- Table of ascensional forces 162
 Tables of density 260
 Tactical reconnaissance machines 245
 Tactics in air duels 53

- Tail cups 164
Tanks 247
Target 71, 74, 76, 122
Tanbe 130
Taylor, Capt. R. L. 210, 215
Taylor, Rear Admiral David W. 214, 215
Technical training, balloons 163
Tehanak, City of 91
Telephone car 82
Telephonic communication 159
Tenth Int. Geog. Congress 201, 203
Temperature 260, 263
Tennessee 211
Tension 255, 256
Test cut out 270
Testing aeroplanes 259
Testing cordage and fabric for balloons 164
Testing Squadron 259, 261, 264
Tests for aviators' certificates 186
Tests, wind channels 275
Texas 211
Texas City, Mex. 205
Thaw, Lieut. William 211, 241
Thermometers 165
Thermos flask 261
Thomas-Morse 291-292
Thrust 256
Tillotson, Brig. Gen. Lee S. 212
Timm Aviation Co. 244
Tiraudes 88
Tizard, Capt. H. F. 259
Toronto 216
Torpedoplane 12
Torpedo attacks 9
Torque 247, 256
Torsion 255
Touring Club of Italy 203
Towers, Lieut. Commander J. H. 202
Training aviators for U. S. Army 179
Training balloon companies 164
Training fields 180, 187
Training Field, American 186
Training machines 244
Training machines, American 212
Trajectory 32
Transmission of messages 112
Transmission, wireless 141
Transportation, balloons 81
Trenches 70, 71, 75, 90, 105, 159
Trenches, British 130
Trench shelters 70
Trentino Army 6
Trentino front 72
Trial flights 224
Trieste Raids 19
Triplane scout "S3" 244
Triplane, advantages of 45
Triplane, Caproni 278
"Tripe Hound" 13
Tripoli 229
Tropics, uniforms 195
Tubing for fuel leads 250
Tube wagon 84
Tuning vibrator 142
Turkish-German positions 125
Turney, George W. 202
Turner, K. M. 202
Twin-motored J N Tractor 244
Twin motored Handley Page 276
Two engined aeroplanes 239
Two place machines 246
Two propeller system 246
Types of Aeronautic Maps 197
- U-boat bases 9, 21
Uniforms regulations 193
Uniforms, specifications 190
Uniforms, U. S. Aeronautic Personnel 190, 193
United Eastern Aero Corp. 242, 299
United States 7, 170, 173, 186, 193, 195, 201, 212, 224, 245, 282
aero maps 197
aeronautic personnel, regulations for uniforms 190, 193
aeronautics, history of 204
armed machines 47
- United States—Continued
aviation students 181
dirigibles 157
Government 223
Government wireless sets 153
Navy Radio Division 154
training of aviators 179
training fields 186
War Department 222
wireless students 141
United States Army 76, 204, 205, 208, 209, 245
Aviation School 210
Balloon Co. 169
Balloon School 163, 163
Balloon School, Ft. Omaha 167
biplanes, U. S. 140
gasoline supply system 242
Reserve Military aviators test 189
service insignia 190
uniforms 195
University of California 216
Illinois 216
Ohio 216
Texas 216
University students studying aviation 181
Use maps and compass with free balloon 164
Useful load 245
Uselli, C. 203
- Valve cord 163
Valve line 258
Vanderbilt, Col. Cornelius 202
Vanderbilt, W. K. 202
Variable-camber wing 252
inductance 148
pitch blade 254, 255
pitch propeller 253, 265
pull 128
radiators 252
Varnishing cotton balloons 164
Velocity 247
Velocity of aeroplane 275
Verdun 64, 128
Vermont 212
Vernys Light 75, 76, 128
Vervy pistol 73, 76
V formation 30
Vibration 248
Vibration absorbing material 252
Vickers gun 48, 72
Vickers Scout 286
Vienna International Aeronautical Federation 201
Vilas, L. A. 202
Villa's raid 208
Vincent, J. C. 219
Virginia 212
Virginia National Guard 164
Visual signal codes for balloons 168
Vitriol process 168
Voisin 32, 47, 222, 228, 269, 290
Voisin Brothers 226
Voisin-Peugeot gun plane 54
Volunteer forces 180
- Waldon, Sidney D. 214, 215
Walker, J. Bernard 217
Walker, John C. 204
Walvets 64
Wanamaker, Rodman 210
War, decision of 3
War Department 179, 217, 245
Wardrop, G. Douglas 202
Wards, Lieut. Forest 210
Ward, T. F. 211
War kites 99
War office 229
War with Mexico 204
Washington, Cutting A., radio set 153
Washington, D. C. 179
Washington Signal Corps Flying School 182
Water gas for hydrogen 176
Watkins, Lieut. B. O. 215
Wave length, wireless 142
Weight saving 279
Wellington, quotation 111
- Wendell, Evert Jansen 237
Western battle front 107
Western front 82, 98
Western theater of war 18
West Virginia 212
Wheeler, Lieut. D. R. 215
Wheeler, Monroe 202
Wheeler, S. S. 202
White, Brig.-Gen. George H. 211
White House 212, 217
Whitney, Harry Payne 20
Wilhelmshaven 7, 10
Willard, Daniel 21
Willets, Lieut. W. P. 210, 211, 215
William, I. R. 230
Williams Aero Co. 244
Willis, Lieut. R. H. 208
Willoughby, Hugh L. 202
Wilson Aerial Highway 200
Winch for kite balloons 159
Wind channel experiments 275
Winding drum 161
Windlass 161
Windlass wagon 81
Wing construction 253
Wing section 259
Winter gloves for aviators 191
Winter, Lieut. John C. 204
Wire gauze strainer 250
Wireless 75, 76, 77, 121, 138
aerials 142
aero transmitter 150
apparatus, Breguet 148
communication 139
control of artillery fire 142, 149
Culver set 154
equipment 138
observer 147
helmet 138
installation 148
receiving apparatus 152
receiving station 151
receiving trucks 144
sets for U. S. Gov. 153
signaling 147
speed of sending 141
station, German 151
transmission 141, 142
transmission sets 246
trucks 145
units 150
Washington set 153
Wire telephone 140
Wise Wood, Henry A. 202, 217, 238
Wittebann-Lewis Co. 244, 299
Wood, Brig. Gen. Fred. W. 210
Woodhouse, Henry 201, 217, 234, 237
Woods bulls eye 158
Wright 222
Wright aeroplane 204, 207, 226, 236
Wright, Captain Frank W. 211
Wright-Martin Co. 237, 291-292
Wright, Orville 202, 204, 205, 222, 224, 225, 226, 225
Wright, Rev. Milton 221, 225
- Young, Brig.-Gen. L. W. 211
Young, William Wallace 202
- Zahn, Francis A. 202
Zeebrugge 7
Zeppelins 20, 126, 134, 135, 137, 143, 157, 240
bomb 37
bomb dropping mechanism 22
duty 127, 133
raids 24, 125
incendiary bomb 34
over Berlin 156
radio 154
(See Textbook of Naval Aeronautics and D'Orcey's Airship manual.)
wireless 138
wireless stations 152
wreck 110
Zone call system 122



14 DAY USE
RETURN TO DESK FROM WHICH BORROWED

LOAN DEPT.

This book is due on the last date stamped below, or
on the date to which renewed.

Renewed books are subject to immediate recall.

Jan 29 '62 DGX	REC'D LD
REC'D LD	MAY 22 '64 - 5 PM
JAN 18 1962	FEB 27 1969 NX
5 Apr '62 MW	RECEIVED
REC'D LD	FEB 19 '69 - 6 PM
APR 5 1962	LOAN DEPT.
<i>May '62 DG</i>	
REC'D LD	
JUN 21 1962	JUN 9 1970
5 May '64 V1	DEC 08 1987
6 June	
REC'D LD MAY 26 70 - 5 PM 8 8	
	DEC 14 1987

LD 21A-50m-8,'61
(C1795s10)476B

General Library
University of California
Berkeley

VE 00351

U.C. BERKELEY LIBRARIES

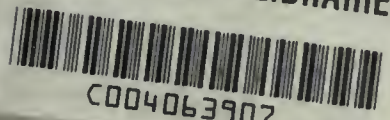

C004063907

